

Status: 06/2018



Products need labeling  
Label printers  
for industrial applications



**SQUIX**  
Made in Germany

- 3** SQUIX label printers for industrial applications
- 4 - 5** Industrial printers with a left-aligned material guide
- 6 - 7** Label printers with a centered material guide
- 8** Operation panel
- 9** Print heads, print rollers, interfaces
- 10 - 11** Technical data
- 12 - 13** Label software cablabel S3
  - Printing in stand-alone operation
  - Printer control and administration
- 14 - 17** Accessories
- 18 - 19** Applicator S1000
- 20** Applicator S3200
  - Demand modules
- 21** All-around labeler
  - Mounting equipment
- 22** Label printers with special covers or protection chassis
- 23** Maintenance, services, training
- 24 - 26** Delivery program

Scopes of delivery, design and technical specifications correspond to the date of the printing.  
Subject to change. The data provided in the catalog do not represent any warranty or guarantee.



Information is also  
available on the Internet:  
[www.cab.de/en/squix](http://www.cab.de/en/squix)



## SQUIX

Label printers for industrial applications

The professional **SQUIX** label printers are the further development of the successful A<sup>+</sup> printer series. They fit with a wide range of industrial applications. They have been developed with focus on easy and convenient operation and high reliability.

The print mechanics and the chassis are made of high-quality materials and perfectly match in terms of shape and function. A large number of peripherals and software enable customer-specific solutions.

Whether they are operated in stand-alone mode, in a PC application or within a network - the rugged SQUIX printers are always up to the mark. The high-speed processor ensures fast job processing and immediately provides the required label.

- innovative technology
- easy operation
- accurate imprint
- reliable and fast printing
- compact, appealing design
- highest quality standards

Sample applications:

### PCB labels

When only little space is available  
– smallest label size 4 x 3 mm



### Type plates

Pin sharp fonts, graphics and barcodes  
up to 600 dpi



### Cardboard box and pallet labels

up to A5 size





# Industrial printers



Material guide  
left-aligned



## 1.1 The slim one

for small labels when little footprint is available

Label printer		SQUIX 2	
Printable resolution	dpi	300	600
Print speed	up to mm/s	250	150
Print width	up to mm	56.9	54.1



## 1.2 The universal one

The best-selling industrial device with a wide range of accessories.

Label printer		SQUIX 4.3		SQUIX 4	
Printable resolution	dpi	203	300	300	600
Print speed	up to mm/s	250	250	300	150
Print width	up to mm	104	108.4	105.7	105.7



## 1.3 The wide one

for Odette and UCC labels in applications in logistics

Label printer		SQUIX 6.3	
Printable resolution	dpi	203	300
Print speed	up to mm/s	250	250
Print width	up to mm	168	162.6



## Basic versions

for printing on labels and continuous materials that are wound on rolls or fanfold. The material is separated at the jagged tear-off edge. Optionally, it can be cut or externally rewound.



## Peel-off versions P

In addition to the basic version the labels can also be dispensed. The label is separated from the carrier material after the printing. It can be removed manually or by an applicator. Delivery includes I/O interface



## The extra wide one

for pallet and barrel labels

Label printer		A8 <sup>+</sup>
Printable resolution	dpi	300
Print speed	up to mm/s	150
Print width	up to mm	216

For further information on the A8<sup>+</sup> see  
[www.cab.de/en/a8plus](http://www.cab.de/en/a8plus)

## Details



Label printer  
SQUIX 4 P

### 1 Hinged cover

The two-part cover made of impact-proof plastics folds when it is opened. Therefore, only little footprint is needed. The large panoramic window enables to check the material consumption and to track the full printing process.

### 2 Plungers

One plunger is fixed at the inner side. The second one is adjusted that far to the edge of the label until a good print image is ensured.

### 3 Rugged metal chassis

made of cast aluminum; basis to assemble all components

### 4 Peel-off function

Via the peel-off plate, the label is separated from the carrier material. Accurate imprint and dispense are achieved with the powered rewind assist roller and the pinch roller.

### 5 Periphery connection

Additional modules are easy to connect. All peripheral devices are plugged to the printer with two pins and fixed with a screw.

### 6 Ribbon holder

Fast and easy exchange of the ribbon is enabled with the three-part tightening axles.

### 7 Roll holder

The spring-mounted margin stop with a screw cap enables constant tension during material feed and therefore improves accurate imprint. If rolls with 100 mm core diameter are processed, an adapter is recommended.

### 8 Internal rewinder

Peel-off versions allow to rewind labels or carrier materials with or without a cardboard core. The three-part tightening axle provides easy material handling.

### 9 Rocker

When printing is started, the spring-mounted rocker with pulleys made of Teflon dampens the tension and therefore improves accurate imprint.

### 10 Material guide

It is mounted on the rocker. The stop is adjusted to the edge of the label with the rotary knob.

## Label printers M series



**Material guide centered**



Basic version



Peel-off version P

### 1.4 The accurate and versatile one

for printing on all materials that are wound on rolls or reels or fanfold - especially very small labels or slim continuous materials such as pressed shrink tubes.

As regards the label width, no adjustment of the plungers is needed.

Width-adapted print rollers are provided for slim materials.

Label printer		SQUIX 4.3 M		SQUIX 4 M	
Printable resolution	dpi	203	300	300	600
Print speed	up to mm/s	250	250	300	150
Print width	up to mm	104	108.4	105.7	105.7

### Differences compared to a left-aligned material guide

#### 1 Ribbon holder

Easy insertion of the ribbons is enabled with the three-part tightening axles. A preprinted ruler simplifies the adjustment.

#### 2 Roll holder

When setting the margin stop, the material roll is automatically centered. If rolls with 100 mm core diameter are processed, an adapter is recommended.

#### 3 Plungers

Both plungers are fixed for all material widths. No print head settings or adjustments are necessary.

#### 4 Material guide

The material guide just in front of the print roller provides accurate imprint. The material width is adjusted with a spindle.



Label printer SQUIX 4 MP

#### Slim print rollers

To achieve accurate imprint with slim materials and ribbons slim print rollers are needed. These prevent from print roller wear, print head contamination and errors during material feed.

Coating: synthetic rubber



DR4-M25



DR4-M50



DR4-M80

## Label printers MT series



**Material guide  
centered  
with separator**



### 1.5 The textile printer

It is also possible to print on labels or continuous materials that are wound on rolls or reels.

As regards the label width, no adjustment of the plungers is needed.

Width-adapted print rollers are provided for slim materials.

Label printer		SQUIX 4.3 MT	SQUIX 4 MT	
Printable resolution	dpi	300	300	600
Print speed	up to mm/s	250	300	150
Print width	up to mm	108.4	105.7	105.7

### Differences compared to a left-aligned material guide

#### 1 Ribbon holder

Easy insertion of the ribbons is enabled with the three-part tightening axles. A preprinted ruler simplifies the adjustment.

#### 2 Roll holder

When setting the margin stop, the material roll is automatically centered. If rolls with 100 mm core diameter are processed, an adapter is recommended.

#### 3 Plungers

Both plungers are fixed for all material widths. No print head settings or adjustments are necessary.

#### 4 Antistatic brush

Particularly with plastic materials the electrostatic charge is discharged after printing.

#### 5 Separator

At high heat energy the ribbon can stick with the textile tape. A roller reliably separates the material from the ribbon.

#### 6 Material guide

The material guide just in front of the print roller provides accurate imprint. The material width is adjusted with a spindle.

#### Slim print rollers

To achieve accurate imprint with slim materials and ribbons slim print rollers are needed. These prevent from print roller wear, print head contamination and errors during material feed.

Coating: synthetic rubber









# Operation panel

## Intuitive and easy operation with self-explanatory symbols to configure the device setups

- 1 **LED signal:** Power ON
- 2 **Status bar:** Data reception, Record data stream, Ribbon warning, SD memory card / USB memory stick plugged in, Bluetooth, WLAN, Ethernet, USB Slave, Time
- 3 **Printer status:** Ready, Pause, Number of printed labels per print job, Label in peel-off position, Awaiting external start signal
- 4 **Periphery buttons**
  - Cutter/perforation cutter: direct cutting
  - External rewinder: winding outside or inside
  - Tear-off or peel-off mode: print the next label
  - Applicator: label application
- 5 **Operation**

 Jump to menu	 Stop and delete all print jobs
 Reprint last label	 Label feed
 Interrupt and continue print job	
- 6 **USB slot** for the Service Key or a memory stick, to load data in the IFFS storage
- 7 **USB WLAN stick** 2.4 GHz 802.11b/g/n included as an extra item in the scope of delivery; In hotspot mode it is possible to directly connect a mobile device with the printer via WLAN.



**Setup options**



**Printing parameters**



**Print position Y**  
Fast setup with a slider,  
fine setup with ± keys



**Print speed selection**  
via scroll function



**Video tutorials**  
Scan QR code with a  
mobile device and watch  
the explanatory video



## Print heads



**All print heads are freely interchangeable at equal width. They are automatically detected and calibrated by the CPU.**

Major data such as running performance, maximum operating temperature and heat energy are directly stored in the print head. The data can be read at the plant.

**Print heads for SQUIX 2, SQUIX 4 - 300, 600 dpi**

for a sharp-edge print image  
for type plates with small fonts, graphics  
and material marking with high energy needs

**Print heads for SQUIX 4.3, SQUIX 6.3 - 203, 300 dpi**

durable, for rough surroundings and thermal direct printing

## Print rollers in two types of material



**Print rollers DR**

Coating: synthetic rubber  
They are suited for accurate imprint and provided as standard.

**Print rollers DRS**

Coating: silicone  
They have an extra long service life at a higher imprint tolerance.

## Interfaces on the back of the device



**1 Slot for SD memory card**

**2 2 x USB host interfaces** to connect a Service Key, USB memory stick, keyboard, barcode scanner, USB Bluetooth adapter, USB WLAN stick

**3 USB 2.0 Hi-speed device** to connect a PC

**4 Ethernet 10/100 BASE-T**

**5 RS232C interface** 1,200 to 230,400 baud/8 bit

**6 3.1 I/O interface** standard with peel-off devices, accessory to basic devices Labeling is started with a PLC, a sensor or a hand switch. At the same time, status and error messages are issued.

Compliant with IEC/EN 61131-2, type 1+3; all inputs and outputs are galvanically isolated and protected from reverse polarity. In addition, outputs are short circuit protected.

**Inputs PNP**

Start print and apply  
Print first label  
Reprint  
Delete print job  
Label dispensed  
Interrupt labeling  
Pause  
Reset

**Outputs PNP; NPN on request**

Printer/periphery ready  
Print job available  
Applicator in initial position  
Paper feed ON  
Label in peel-off position  
Applicator in apply position  
Pre-warning to end of ribbon  
Common error

# Technical data

● Typical ○ Possible ■ Standard □ Option

		1.1		1.2			1.3		1.4			1.5						
Label printer		SQUIX 2		SQUIX 4.3		SQUIX 4		SQUIX 6.3		SQUIX 4.3 M		SQUIX 4 M		SQUIX 4.3 MT		SQUIX 4 MT		
Material feed		left-aligned																
Printing method	Thermal transfer	●	●	●	●	●	●	●	●	●	●	●	●	●	●	●	●	●
	Thermal direct	○	-	●	●	○	-	●	●	●	●	○	-	●	○	-	○	-
Printable resolution	dpi	300	600	203	300	300	600	203	300	203	300	300	600	300	600	300	600	
Print speed	up to mm/s	250	150	250	250	300	150	250	250	250	250	300	150	250	300	150	150	
Print width	up to mm	56.9	54.1	104	108.4	105.7	105.7	168	162.6	104	108.4	105.7	105.7	108.4	105.7	105.7	105.7	
Print start	Distance to locating edge	mm		2	2.8	1.2	2	0.5	3.2	centered								
<b>Material</b>																		
Roll, fanfold, reel (reel only with centered devices)	Paper, cardboard, PET, PE, PP, PI, PVC, PU, acrylate, Tyvec	●		●			●		●			●		●		●		
	Smart Labels	-		●			●		●			●		○		○		
	Ready-for-use shrink tubes	-		○			○		○			●		○		○		
	Pressed continuous shrink tubes	-		-			-		-			●		○		○		
	Textile tapes	-		-			-		-			○		○		●		
Labels <sup>1)</sup>	Width	mm		4-63		20-116			46-176			4-110			4-110			
	Height without label backfeed <sup>2)</sup>	from mm		4		4			6			3			4			
	with label backfeed <sup>2)</sup>	from mm		4		6			12			4			6			
	with label backfeed when dispensing	from mm		6		6			12			6			-			
	Maximum height	mm		2,000														
Thickness	mm		0.03-0.60															
Carrier material	Width	mm		24-67		24-120			50-180			9-114			9-114			
	Thickness	mm		0.03-0.16														
Continuous material	Width	mm		24-67		24-120			50-180			9-114			9-114			
	Thickness	mm		0.05-0.50														
	Weight (cardboard)	up to g/m <sup>2</sup>		300														
Shrink tubes	Width ready-for-use	up to mm		-		120			-			114			114			
	Width continuous	mm		-		-			-			4-85			4-85			
	Thickness	up to mm		-		1.1			-			1.1			1.1			
Roll, reel	Outside diameter with core diameter	mm		205 / 38.1-76 180 / 100														
	Winding	outside or inside																
<b>Ribbon<sup>3)</sup></b>																		
Ink side	outside or inside																	
Roll diameter	up to mm	80																
Core diameter	mm	25.4																
Variable length	up to m	450																
Width	mm	25-57		25-114			50-170			25-114			25-114					
<b>Internal rewinder in peel-off version</b>																		
Outside diameter	up to mm	142														-		
Core diameter	mm	38.1-40														-		
Winding	outside																	
<b>Printer sizes and weights</b>																		
Width x Height x Depth	mm	200x288x460		252x288x460			312x288x460			252x288x460			252x288x460					
Weight	kg	9		10			14			10			10					
<b>Label sensor with position indication</b>																		
Gap sensor for	labels, punch marks or print marks in transparent materials and end of material																	
Reflective sensor from below or top for	print marks in not transparent materials and end of material																	
Distance sensor	to locating edge	left-aligned		mm		5-26		5-60			5-60			-		-		
	from center to locating edge	centered		mm		-		-			-			0-55		0-55		
Height of material gap	up to mm	2																
<b>Electronics</b>																		
Processor 32 bit clock rate	MHz	800																
Main storage (RAM)	MB	256																
Data storage (IFFS)	MB	50																
Slot for SD memory card (SDHC, SDXC)	up to GB	512																
Battery for time and date, real-time clock	■																	
Data storage when power is off (e.g. serial numbers)	■																	
USB WLAN stick 2.4 GHz 802.11b/g/n	■ (included as an extra item in the scope of delivery)																	
<b>Interfaces</b>																		
RS232C 1,200 to 230,400 baud/8 bit	■																	
USB 2.0 Hi-speed device to connect a PC	■																	
Ethernet 10/100 BASE-T	LPD, IPv4, RawIP printing, DHCP, HTTP/HTTPS, FTP/FTPS, SMTP, SNMP, TIME, NTP, Zeroconf, SOAP web service, VNC																	
1 x USB host at the operation panel for	Service Key or USB memory stick																	
1 x USB host at the operation panel for	USB WLAN stick 2.4 GHz 802.11b/g/n																	
2 x USB host on the back side for	Service Key, USB memory stick, keyboard, barcode scanner, USB Bluetooth adapter, USB WLAN stick																	
WLAN 802.11b/g/n, hotspot or infrastructure mode	GHz	2.4 ■ / 5 □																
Periphery connection USB host, 24 VDC	■																	
Digital I/O with 8 inputs and outputs	Peel-off/basic device	■/□																

<sup>1)</sup> Limitations may apply to small labels, thin materials or strong adhesives. Critical applications need to be tested.

<sup>2)</sup> when tearing off, cutting, rewinding

<sup>3)</sup> The ribbon should at least correspond with the width of the carrier material.

# Technical data

■ Standard □ Option

Operating data	
Power supply	100-240 VAC, 50/60 Hz, PFC
Power consumption	Standby <10 W / typical 150 W / maximum 300 W
Temperature / Operation	+5 - 40°C / 10 - 85 % not condensing
humidity	Storage 0 - 60°C / 20 - 85 % not condensing
	Transport -25 - 60°C / 20 - 85 % not condensing
Approvals	CE, FCC class A, CB, CCC, c UL
Operation panel	
	Touchscreen LCD color display
Screen diagonal	4.3"
Resolution (Pixel) W x H	272 x 480
Setup options	
Print Labels	Region: Language
Ribbon	Country
Tear-off	Keyboard
Peel-off	Time zone
Cut	Time
Apply	Display: Brightness
Interfaces	Power safe mode
Error	Orientation
	Interpreter
Status bar	
Data reception	Bluetooth
Record data stream	WLAN
Ribbon warning	Ethernet
SD memory card plugged in	USB Slave
USB memory stick plugged in	Time
Monitoring	
Ribbon winding	Print head tension
Ribbon pre-warning	Print head temperature
End of ribbon	Print head open
End of material	Pinch roller open
Periphery error	(with peel-off version and separator)
Test routines	
System diagnostics when	Device is switched on, including print head detection
Information display, status printout, analysis	Fonts list, type overview, WLAN status, label profile, test grid, monitor mode, recording print data on memory card
Status reports	- Printout of system settings, for example print lengths and running times - System status request via software command - Information display of, for example, network error, missing link, barcode error, periphery error, etc.
Fonts	
Font types	5 bitmap fonts including OCR-A, OCR-B and 3 vector fonts Swiss 721, Swiss 721 Bold, Monospace 821 are provided internally, TrueType fonts may be stored
Character sets	Windows 1250 bis 1257, DOS 437, 737, 775, 850, 852, 857, 862, 864, 866, 869, EBC DIC 500, ISO 8859-1 to -10 and -13 to -16, WinOEM 720, UTF-8, Macintosh Roman, DEC MCS, K018-R  All West and East European, latin, cyrillic, Greek, Hebrew and Arabic characters, Chinese and Thai are supported.
Bitmap fonts	Size in width and height 1-3 mm Zoom factor 2 to 10 Orientation 0°, 90°, 180°, 270°
Vector/TrueType fonts	Size in width and height 0.9-128 mm Variable zoom Orientation 360° in steps of 1°
Font styles	Bold, italic, underlined, outline, inverse - depending on the font type
Character spacing	Variable or Monospace for fixed character spacings

Graphics	
Graphic elements	Lines, arrows, rectangles, circles, ellipses - filled and filled with fading
Graphic formats	PCX, IMG, BMP, TIF, MAC, GIF, PNG
Barcodes	
Linear	Code 39, Code 93 Code 39 Full ASCII Code 128 A, B, C EAN 8, 13 EAN/UCC 128/GS1-128 EAN/UPC Appendix 2 EAN/UPC Appendix 5 FIM HIBC  Interleaved 2/5 Ident- and routing code of Deutsche Post Codabar JAN 8, 13 MSI Plessey Postnet RSS 14 UPC A, E, E0
2D and stacked	DataMatrix DataMatrix Rectangle Extension QR code GS1 QR code Micro CR code PDF 417 Micro PDF 417 UPS MaxiCode GS1 DataBar Aztec Codablock F RSS 14 truncated, limited, stacked, stacked omni-directional EAN/GS1 DataMatrix  All codes are variable as regards height, modular width and ratio; orientations 0°, 90°, 180°, 270°  optional check digit, plain text printout and start / stop code depending on the type of code
Software	
Label software	cablabel S3 Lite cablabel S3 Viewer cablabel S3 Pro cablabel S3 Print
Running also with	CODESOFT NiceLabel EASYLABEL BarTender
Stand-alone operation	
WHQL certified Windows printer drivers for	Windows Vista Windows 7 Windows 8 Windows 8.1 Windows 10  Server 2008 Server 2008 R2 Server 2012 Server 2012 R2 Server 2016
Apple Mac OS X printer drivers	from version 10.6
Linux printer drivers	from CUPS 1.2
Programming	Printer language JScript abc Basic Compiler
Integration	SAP Database Connector
Emulation	ZPL (Data stream has to be tested in advance.)
Administration	Printer control Configuration in Intranet and Internet Network Manager (in preparation)



# Label software cablabel S3

## Designing, printing, administrating with cablabel S3

cablabel S3 opens up the full potential of cab devices.

First of all, the label must be designed. Only when it comes to printing it has to be decided whether the label shall be processed on a label printer, a print and apply or marking laser system.

cablabel S3 is of a modular design which makes it adaptable to requirements step by step. To support functions like native JScript programming, elements such as the JScript Viewer are embedded as plug-ins. The designer user interface and the JScript code are synchronized in real time. Special functions like the Database Connector or barcode testers can be integrated.

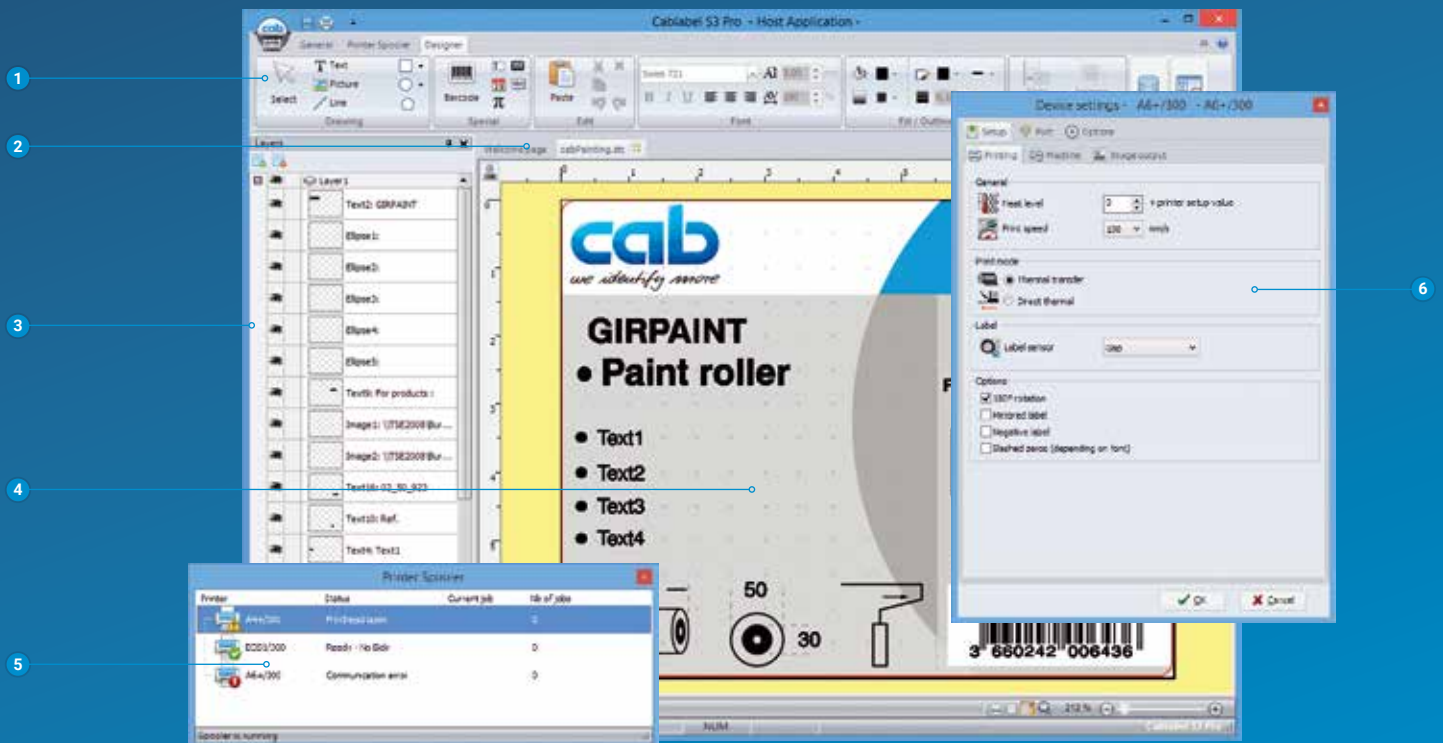

- 1 **Toolbar**  
to create different label objects
- 2 **Tabs**  
to quickly switch from one running label design to another
- 3 **Layers**  
to administrate different label objects
- 4 **Designer**  
simplifies the label design and displays the label WYSIWYG
- 5 **Printer spooler**  
to monitor all print jobs and the state of the printer
- 6 **Drivers**  
for setting and the communication with devices

## Printing in stand-alone operation

This operating mode is the printer's ability to select and print labels even when it is not connected to a host system.

The label has to be designed with a software such as cablabel S3 or by direct programming with a text editor on a PC. Label formats, texts, graphics as well as database contents are stored on a memory card, a USB memory stick or in the internal IFFS memory.

Only variable data are sent to the printer via a keyboard, a barcode scanner, scales or other host systems and/or recalled by the Database Connector from the host and printed.



For further information see  
[www.cab.de/en/cablabel](http://www.cab.de/en/cablabel)





# Printer control and administration

## Printer drivers

To control the printer with a software other than cablabel S3, cab provides drivers in 32 / 64 bit for operating systems starting from Windows Vista, Mac OS 10.6 and Linux with CUPS 1.2.

 **Windows<sup>1)</sup> drivers**  
cab printer drivers are certified according to WHQL. They ensure optimum stability on the Windows operating system.

 **Mac OS X<sup>2)</sup> drivers**  
cab provides CUPS-based printer drivers for Mac OS X applications.

 **Linux drivers<sup>3)</sup>**  
Linux drivers are CUPS-based.

Drivers are offered on the DVD delivered with the printer and for free download at [www.cab.de/en/support](http://www.cab.de/en/support)

## Printer programming

 **JScript**  
To control the printer, cab has developed the embedded programming language JScript. See manual for free download at [www.cab.de/en/programming](http://www.cab.de/en/programming)

 **abc Basic Compiler**  
In addition to JScript and as an integral part of the firmware, it allows advanced printer programming before data are sent to printout. For example, external printer languages can be replaced without interfering in the current print job. Also data from other systems such as a scale, a barcode scanner or PLC can be integrated.

## Printer integration

 **Printer Vendor Program**  
As a partner in SAP's<sup>4)</sup> Printer Vendor Program, cab has developed a replace method to enable easy control of a cab printer via SAPScript from SAP R/3. Only variable data are sent to the printer by the host. Pictures and fonts that had priorly been stored in the local memory (IFFS, memory card, etc.) are merged.

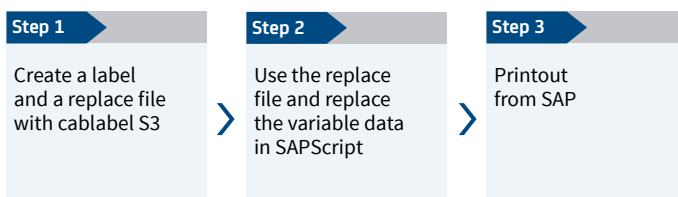

<sup>1)</sup> Windows is a registered trademark of Microsoft Corporation  
<sup>2)</sup> MAC OS X is a registered trademark of Apple Computer, Inc.  
<sup>3)</sup> Only for device series SQUIX (except of SQUIX MT), MACH 4S, EOS, Hermes+ and PX  
<sup>4)</sup> SAP and all corresponding logos are trademarks or registered trademarks of SAP SE

## Printer administration

 **Configuration in Intranet and Internet**  
The HTTP and FTP server integrated in the printer via standard programs like a web browser or FTP clients allows printer control and configuration, firmware updates and memory card administration. Via email or SNMP, the SNMP and SMTP client datagram sends status, warning and error messages to administrators and users. Time and date are synchronized by a time server.



 **Network Manager** in preparation  
It is possible to simultaneously manage several printers within the network. Control, configuration, firmware updates, memory card administration, data synchronization and PIN administration are supported from one single location.

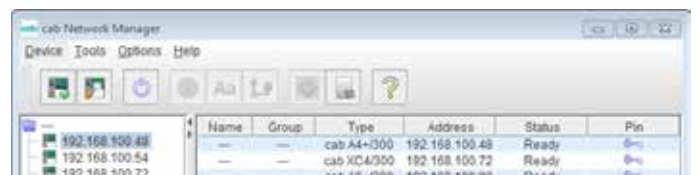

 **Database Connector**  
Printers connected to a network may directly access data from a central ODBC or OLEDB-ready database and print it on a label. While printing, data can be rewritten to the database.



# Overview of accessories





















● Typical ○ Possible ■ Standard □ Option

Pos.	Printer add-ons	Basic device	Peel-off device	1.1	1.2	1.3	1.4	1.5
				SQUIX 2	SQUIX 4.3 SQUIX 4	SQUIX 6.3	SQUIX 4.3 M SQUIX 4 M	SQUIX 4.3 MT SQUIX 4 MT
<b>Extra equipment</b>								
2.2	Print rollers DR4-M25, -M50, -M80	●	●	-	-	-	□	□
	Print roller DRS	●	●	□	□	□	□	□
2.3	Antistatic brush	●	●	□	□	□	□	■
2.6	Adapter 100	●	●	□	□	□	□	□
2.7	SD memory card 8 GB	●	●	□	□	□	□	□
2.8	USB memory stick 8 GB	●	●	□	□	□	□	□
2.9	USB WLAN stick 2.4 GHz 802.11b/g/n + 5 GHz a/n/ac	●	●	□	□	□	□	□
2.10	USB Bluetooth adapter	●	●	□	□	□	□	□
2.11	Barcode tester for linear and 2D barcodes	●	●	□	□	□	□	-
<b>Label dispensing</b>								
2.12	Present sensor PS800	-	●	□	□	□	-	-
2.13	Present sensor PS900	-	●	□	□	□	□	-
2.14	Present sensor PS1000	-	●	-	-	-	□	-
2.15	Extended peel-off plate DP410	-	●	□	□	□	□	-
2.16	Product sensor with reflector	-	●	□	□	□	□	-
<b>Interfaces</b>								
3.1	I/O interface	●	●	□	□	□	□	□
3.2	I/O interface connector, SUB-D 25 pin	●	●	□	□	□	□	□
3.3	Label selection - I/O box	●	●	□	□	□	□	□
<b>Connecting cable</b>								
4.1	Connecting cable RS232 C, 9/9 pin, length 3 m	●	●	□	□	□	□	□
<b>Cutting, perforating, stacking</b>								
5.1	Cutters CU200, CU400, CU600 with cutter tray	●	○	□	□	□	□	□
		●	○	-	□	-	□	-
5.2	Perforation cutters PCU400/2,5, PCU400/10	●	○	-	□	-	□	□
5.3	Stacker with cutter and base frame ST400 M	●	○	-	-	-	□	□
<b>Label rewinding, unwinding</b>								
6.1	Rewind guide plates RG200, RG400	-	●	□	□	-	□	-
6.2	External rewinders ER204, ER206 from Q3/2018	●	○	-	□	□	○	○
6.3	External rewinders ER1/210, ER2/210 <sup>1)</sup>	●	○	-	□	□	○	○
6.5	External rewinders ER4/300, ER6/300	●	○	-	□	□	○	○
6.6	External unwinders EU4/300, EU6/300	●	○	-	□	□	□	□
6.7	Adapter kit for rewinders and unwinders	●	○	-	□	□	□	□
<b>Applicators and demand modules</b>								
7.1-7.5	Applicators S1000-220, -300, -400	-	●	□	□	□	□	-
7.6-7.8	Applicator S3200	-	●	□	□	-	□	-
7.9	Demand modules S5104, S5106	-	●	-	□	□	-	-
7.10	All-around labeler	-	●	□	□	-	□	-
<b>Mounting equipment</b>								
8.1	Mounting plate	-	●	□	□	-	-	-
8.2	Profiles 40, 80, 120 mm	-	●	□	□	-	-	-
8.3	Base plate 500 x 255 mm	-	●	□	□	-	-	-
8.4	Floor stand 1600	-	●	□	□	□	-	-
8.5	Printer holder	-	●	□	□	□	-	-
<b>Special covers and chassis</b>								
9.1	Hinged cover for ESD sectors	●	●	□	□	□	□	□
9.2	Hinged cover for the food industry	●	●	□	□	□	□	□
9.3	Stainless steel chassis for the food industry	●	●	-	□	○	□	-
9.4	Dust protection chassis	●	●	-	□	○	□	-

<sup>1)</sup> from the A+ printer series, adapted to SQUIX; provided until the external rewinders ER20x are available



# Accessories

Extra equipment		Label dispensing	
2.2	 <p><b>Print roller DR4-M25</b> Material width up to 25 mm Synthetic rubber coating for accurate imprint</p>	2.12	 <p><b>Present sensor PS800</b> for a left-aligned material guide</p> <p>The sensor detects the label in peel-off position. After the label has been removed the next one is automatically printed.</p> <p>Label width from 16 mm Label height from 6 mm Distance to locating edge 7 mm</p>
	 <p><b>Print roller DR4-M50</b> Material width up to 50 mm Synthetic rubber coating for accurate imprint</p>	2.13	 <p><b>Present sensor PS900</b> for a left-aligned or centered material guide</p> <p>The moveable sensor is foremost used with very small labels or labels that are shaped according to user specifications. After the label has been removed the next one is automatically printed.</p> <p>Label width from 4 mm Label height from 6 mm Left-aligned: distance to locating edge 12-60 mm centered: position middle centered</p>
	 <p><b>Print roller DR4-M80</b> Material width up to 80 mm Synthetic rubber coating for accurate imprint</p>	2.14	 <p><b>Present sensor PS1000</b> for a centered material guide</p> <p>The sensor detects the label in peel-off position. After the label has been removed the next one is automatically printed.</p> <p>Label width from 4 mm Label height from 6 mm Position middle centered</p>
	 <p><b>Print roller DRS4</b> Material width up to 120 mm</p>	2.15	 <p><b>Extended peel-off plate DP410</b> for strong-adhesive labels or labels with a thick carrier material that are hard to remove. Only in conjunction with printing on demand triggered via a display button or control signal. A present sensor cannot be used.</p>
2.3	 <p><b>Antistatic brush</b> Particularly with plastic materials the electrostatic charge is discharged after printing.</p>	2.16	 <p><b>Product sensor with reflector</b> Reflective light barrier to automatically detect a product on the conveyor belt</p>
2.6	 <p><b>Adapter 100</b> for label rolls with 100 mm core diameter and more than 180 mm outside diameter</p>	<b>Interfaces</b>	
2.7	 <p><b>SD memory card 8 GB</b></p>	3.1	 <p><b>I/O interface</b> Labeling is started with a PLC, a sensor or a hand switch. At the same time, status and error messages are issued. Standard with peel-off devices, accessory to basic devices</p>
2.8	 <p><b>USB memory stick 8 GB</b></p>	3.2	 <p><b>I/O interface connector, SUB-D 25 pin</b> with screw clamps to connect all control signals to the I/O interface</p>
2.9	 <p><b>USB WLAN stick</b> 2.4 GHz 802.11b/g/n + 5 GHz 802.11a/n/ac in infrastructure mode with rod antenna for extended reach</p>	3.3	 <p><b>Label selection - I/O box</b> Up to 16 different labels per box can be selected from the memory card by a master control, e.g. PLC. Two boxes can be connected. The I/O box allows simple PLC control processes with four inputs and outputs each via abc programming.</p>
2.10	 <p><b>USB Bluetooth adapter</b></p>	<b>Connecting cable</b>	
2.11	 <p><b>Barcode tester for linear and 2D barcodes</b> The readability or content of a horizontally or vertically printed barcode is checked by a camera right after the printing. In case of a faulty code printing is stopped and the label removed.</p> <p>The tester can be used in tear-off mode, peel-off mode or with an external rewinder. For further information see the operator's manual.</p>	4.1	 <p><b>Connecting cable RS232 C</b> 9/9 pin, length 3 m</p>

# Accessories



## Cutting, perforating, stacking

### Cutter CU

Paper labels, self-adhesive labels, cardboard, textile or plastic materials as well as shrink tubes can be cut.

### Cutter tray

to collect up to approx. 50 labels

Technical data			Cutter			
			CU2/400	CU4/400		CU6/400
To be used with			SQUIX 2	SQUIX 4.3 SQUIX 4	SQUIX 4.3 M SQUIX 4 M SQUIX 4.3 MT SQUIX 4 MT	SQUIX 6.3
Material	Width	up to mm	67	120	114	180
	Weight cardboard	gr/m <sup>2</sup>	60-300			
	Thickness	mm	0.05-1.1			
Cutting length		from mm	5			
Gap height		up to mm	2.5			
Cuts/min, without material		up to	100			
Stop print job when			final cutter position has not been reached			
<b>Cutter tray</b>						
Label height		up to mm	-	100	-	-



### Perforation cutter PCU400

Continuous materials such as textiles or shrink tubes are perforated before they are manually separated. In addition, the materials can also be cut.

Technical data			Perforation cutter	
			PCU400/2,5	PCU400/10
To be used with			SQUIX 4.3, SQUIX 4, SQUIX 4.3 M, SQUIX 4 M, SQUIX 4.3 MT, SQUIX 4 MT	
Perforating	Web distance	mm	2.5	10
	Web width	mm	0.5	
Material	Width	up to mm	85	
	Weight cardboard	gr/m <sup>2</sup>	60-300	
	Thickness	mm	0.05-1.1	
Cutting length		from mm	5	
Gap height		up to mm	2.5	
Cuts/min, without material		up to	100	
Stop print job when			final cutter position has not been reached	



### Stacker with cutter ST400 M

- 1 The printed materials are cut and stacked. If the maximum stack height is reached, printing is interrupted. Limitations may apply to stiff or curved materials. We recommend to have these materials tested at our premise.
- 2 With the base frame the devices can be placed anywhere on the table.

Technical data			Stacker with cutter	
			ST400 M	
To be used with			SQUIX 4.3 M, SQUIX 4 M SQUIX 4.3 MT, SQUIX 4 MT	
Material	Width	mm	20-100	
	Weight cardboard	gr/m <sup>2</sup>	60-300	
	Thickness	mm	0.05-0.8	
Cutting length		mm	20-150	
Gap height		up to mm	1.2	
Cuts/min, without material		up to	100	
Stop print job when			Final cutter position has not been reached, paper jam, stacker cover open, stack height has been reached	
Stack height		up to mm	100	



### Support table - label W x H

The support table and the protective cover are adapted to the label size. They have to be ordered separately.

# Accessories

6.1



## Label rewinding

with or without a cardboard core

### Rewind guide plates RG for internal rewinding

Internal rewinding is possible with peel-off printers. The peel-off plate is replaced by a rewind guide plate.

Technical data		Rewind guide plate		
		RG200	RG400	
	To be used with	SQUIX 2 P	SQUIX 4.3 P SQUIX 4 P	SQUIX 4.3 MP SQUIX 4 MP
	Material width	up to mm	67	120
	Roll diameter	up to mm	142	
	Tightening axle for core diameter	mm	38.1-40	
	Winding		outside	

6.2



### External rewinders ER20x from Q3/2018

Until the start of delivery the external rewinders ER1/210, ER2/210 from the A+ printer series are provided.

The rewriter is screwed with the label printer. Label winding is either outside or inside. The electronic swing arm control ensures that the winding stays consistent and tight.

Technical data		External rewriter		
		ER204	ER206	
	To be used with	SQUIX 4.3 SQUIX 4	SQUIX 4.3 M SQUIX 4 M SQUIX 4.3 MT SQUIX 4 MT	SQUIX 6.3
	Material width	up to mm	120	180
	Roll diameter	up to mm	205	
	Tightening axle for core diameter	mm	76	
	Winding		outside or inside	

6.5



### External rewinders ER4, ER6 with built-in power supply

The rewriter may be attached to any external printer. Label winding is either outside or inside. The electronic swing arm control ensures that the winding stays consistent and tight.

Technical data		External rewriter	
		ER4/300	ER6/300
	To be used with	SQUIX 4.3, SQUIX 4 SQUIX 4.3 M, SQUIX 4 M SQUIX 4.3 MT, SQUIX 4 MT	SQUIX 6.3
	Material width	up to mm	180
	Roll diameter	up to mm	300
	Tightening axle for core diameter	mm	76
	Winding		outside or inside

#### Adapter kit for

ER4, ER6 with SQUIX  
ER4, ER6 and EU4, EU6 with SQUIX

6.6



## Label unwinding

### External unwinders EU

ensure consistent label feed with heavy rolls. Either outside or inside wound rolls can be processed.

Technical data		External unwinder		
		EU4/300	EU6/300	
	To be used with	SQUIX 4.3 SQUIX 4	SQUIX 4.3 M SQUIX 4 M SQUIX 4.3 MT SQUIX 4 MT	SQUIX 6.3
	Material width	up to mm	120	180
	Roll diameter	up to mm	390	
	Core diameter	mm	38.1	
		with adapter mm	76	
Winding		outside or inside		

#### Adapter kit for

EU4, EU6 with SQUIX  
ER4, ER6 and EU4, EU6 with SQUIX



# Applicator S1000

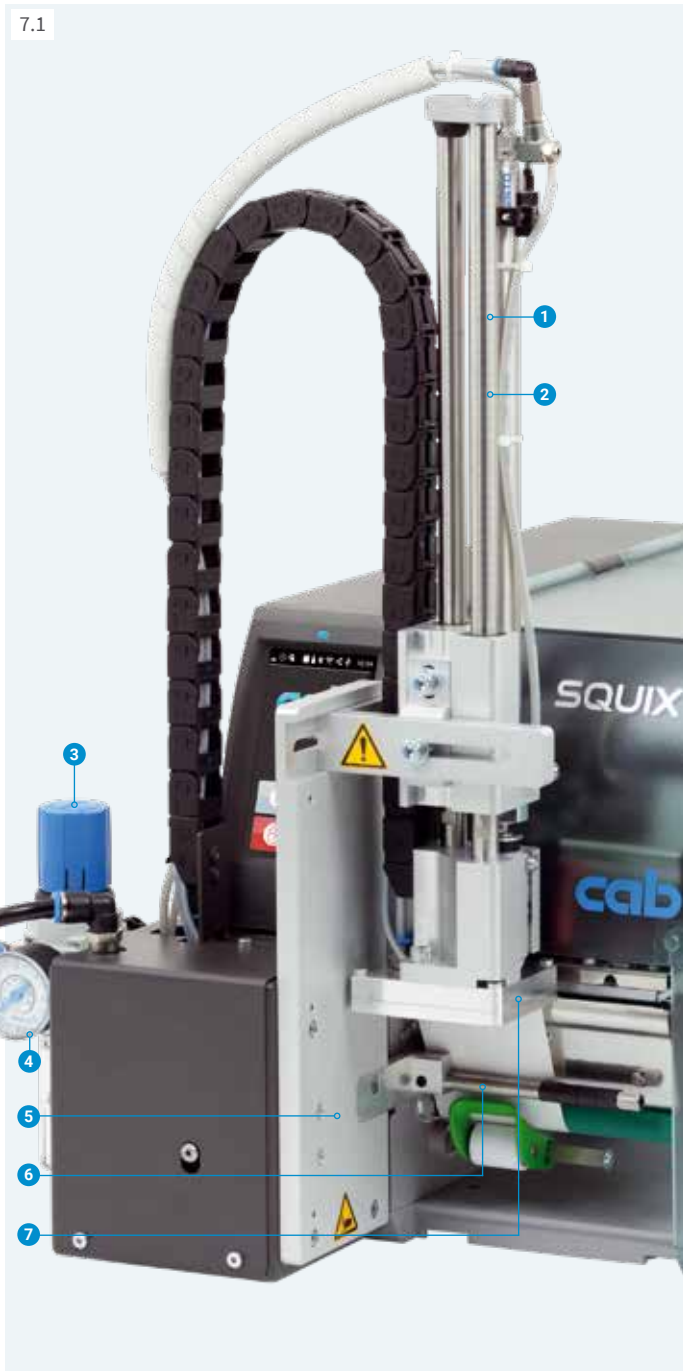

## Labeling in real time

The applicator S1000 fixed to a SQUIX provides a cost-effective solution for peel-off printers - in semi-automatic operation or when vertically assembled in production lines. A stroke cylinder applies the label on the product.

- 1 Long service life**  
Low wear because of a ball-bearing linear guidance
- 2 Variable product heights**  
The stroke cylinder enables labeling at different heights. It is available in various stroke lengths.
- 3 Compressed air pressure regulation unit**  
Micro filters prevent from contamination. The regulation unit enables a permanent high labeling quality.
- 4 High process reliability**  
Supporting air, suction air and the stroke speed are all adjustable. If sensitive products and packagings are processed, the suction force can be reduced to less than 10N (1 kg). The vacuum holes are purged after every labeling process to avoid contamination.
- 5 Label sizes**  
Label widths 25 to 176 mm and heights 25 to 200 mm can be applied.
- 6 Supporting air to blow the labels onto the pad**
- 7 Pad**  
The labels are given to the pad and held there by vacuum. Pad and label are moved by a stroke cylinder to the product.

## Pre-dispense button

to check the labeling process. Pushing the button once means that the label is printed and taken over by the applicator. Pushing the button again starts the labeling process.

Technical data	Applicator			
	S1000-220	S1000-300	S1000-400	
To be used with	SQUIX 2, SQUIX 4.3, SQUIX 4 SQUIX 4.3 M, SQUIX 4 M, SQUIX 6.3			
Cylinder stroke	mm	220	300	400
Tamp stroke below device	mm	64	144	244
Compressed air	bar	4.5		
Cycle time approx. <sup>1)</sup>		25 labels/min		

<sup>1)</sup> Calculated with 100 mm stroke below device, label height 100 mm, print speed 100 mm/s

## Accessories

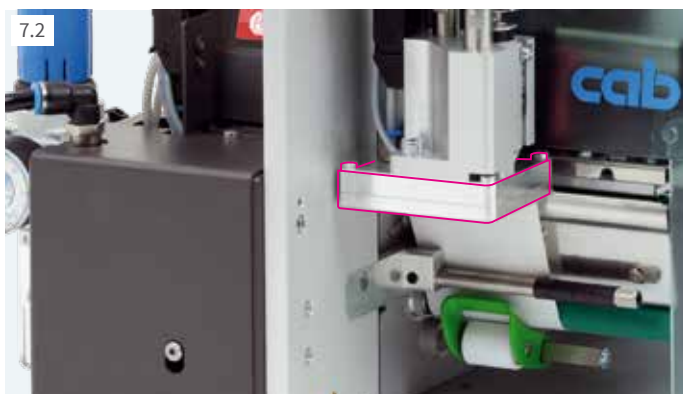

## Universal pads

The rasterized vacuum holes are covered by a foil and pierced according to the label size.

Technical data	Universal pad			
	A1021	A1021		
Material guide	left-aligned, centered			
To be used with	SQUIX 2	SQUIX 4.3 SQUIX 4	SQUIX 4.3 SQUIX 4	
Label width	mm	25-63	25-70	25-90
Label height	mm	25-60		25-90
Product surface		flat		
Product height		variable		
Product during labeling		not in motion		

# Accessories Applicator S1000

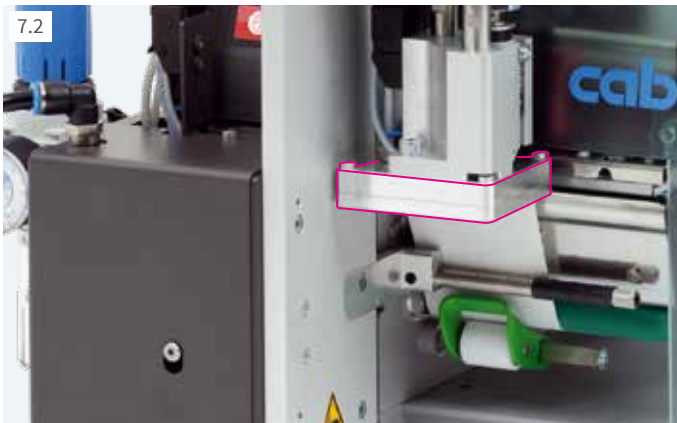

## Tamp pads

are manufactured according to the label size.

		Tamp pad			
Technical data		A1021			M1021
Material guide		left-aligned			centered
To be used with		SQUIX 2	SQUIX 4.3 SQUIX 4	SQUIX 6.3	SQUIX 4.3 M SQUIX 4 M
Label width	mm	25-63	25-116	50-176	25-110
Label height	mm	25-200			
Product surface		flat			
Product height		variable			
Product during labeling		not in motion			

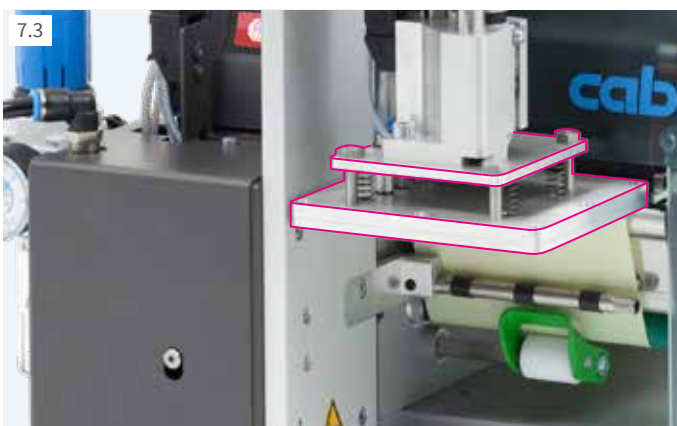

## Universal pads spring-mounted

The spring deflection allows labeling even on curved surfaces. The rasterized vacuum holes are covered by a foil and pierced according to the label size.

## Tamp pads spring-mounted

The spring deflection allows labeling even on curved surfaces; manufactured according to the label size

		Universal pad		Tamp pad	
Technical data		A1321	A1321	A1321	M1321
Material guide		left-aligned, centered		left-aligned	
To be used with		SQUIX 4.3, 4	SQUIX 4.3, 4	SQUIX 4.3, 4 SQUIX 6.3	SQUIX 4.3 M, 4 M
Label width	mm	25-116	25-116	25-116	50-176
Label height	mm	25-102	25-152	25-200	
Product surface		flat			
Product height		variable			
Product during labeling		not in motion			

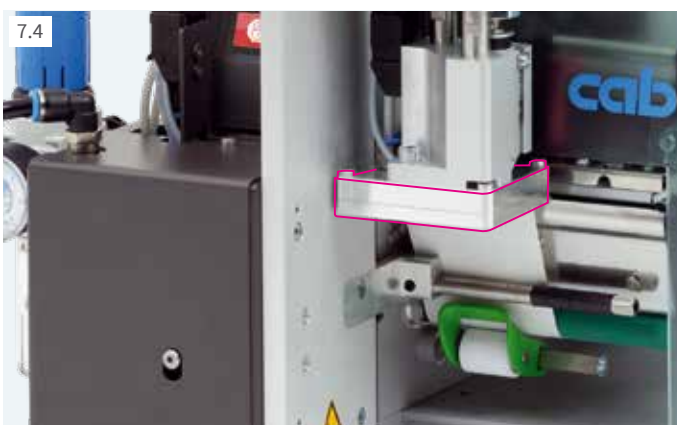

## Blow pads

Labels may be blown on pressure-sensitive products. For this, the blow pad moves to a fixed height. The position of the product that has to be labeled is approx. 10 mm below.

		Blow pad			
Technical data		A2021			M2021
Materialführung		left-aligned			centered
To be used with		SQUIX 2	SQUIX 4.3, 4	SQUIX 6.3	SQUIX 4.3 M, 4 M
Label width	mm	25-63	25-116	50-176	25-110
Label height	mm	25-100			
Product surface		flat			
Product height		fixed			
Product during labeling		in motion or not in motion			

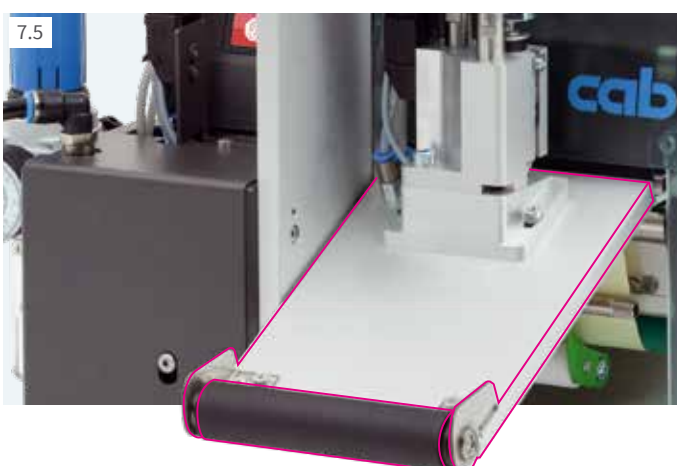

## Roll-on pads

The label is moved right below the roll during the printing. The pad moves onto the product. The label is taken over by the product and rolled on.

		Roll-on pad		
Technical data		A1411		M1411
Material guide		left-aligned		centered
To be used with		SQUIX 4.3, 4	SQUIX 6.3	SQUIX 4.3 M, 4 M
Label width	mm	25-116	50-176	25-110
Label height	mm	80-200		
Product surface		flat		
Product height		variable		
Product during labeling		in motion		

# Applicator S3200



## Labeling in real time

An applicator S3200 fixed to a SQUIX provides a cost-effective solution for peel-off printers - in semi-automatic operation or when vertically assembled in production lines. With the S3200 printed labels are automatically applied on the product. The labels are placed with a rotary cylinder 45° to 95° to the horizontal and applied on the product with a short stroke cylinder. All information on the service life, predisense, compressed air regulation, process reliability and supporting air correspond with the applicator S1000 (see page 18).

		Applicator
<b>Technical data</b>		<b>S3200</b>
To be used with		SQUIX 2, SQUIX 4.3, SQUIX 4, SQUIX 4.3 M, SQUIX 4 M
Rotary cylinder		45°-95°
Stroke cylinder	up to mm	30
Compressed air	bar	4.5
Cycle time approx. <sup>1)</sup>		20 labels/min

<sup>1)</sup> Calculated with label height 40 mm, print speed 100 mm/s

## Tamp or blow pads

are manufactured according to the label size.

		Tamp pad		Blow pad	
<b>Technical data</b>		A3200-1100	M3200-1100	A3200-2100	M3200-2100
Material guide		left-aligned	centered	left-aligned	centered
To be used with		SQUIX 2	SQUIX 4.3, 4	SQUIX 4.3 M, 4 M	SQUIX 2
Label width	mm	4-63	10-116	4-110	10-63
Label height	mm	6-80		10-80	
Product surface		flat			
Product during labeling		not in motion		in motion or not in motion	

# Demand modules



## Demand modules S5104, S5106

to label products in motion on a conveyor belt. A product sensor detects the labeling position. The peel-off process is started and at the same time the next label is printed. The transport speed has to be synchronized with the print speed. A reflective sensor monitors the positioning.

		Demand module	
<b>Technical data</b>		<b>S5104</b>	<b>S5106</b>
To be used with		SQUIX 4.3, SQUIX 4	SQUIX 6.3
Material guide		left-aligned	
Label width	mm	25-116	50-176
Label height	mm	25-200	
Distance from print line to peel-off plate	mm	336-518	
Product surface		flat	
Product height		fixed	
Product during labeling		in motion, speed synchronized with the printer	
Cycle time approx. <sup>1)</sup>		60 labels/min	

<sup>1)</sup> Calculated with label height 100 mm, print speed 100 mm/s



# All-around labeler



## All-around labeler

With the module cylindrical objects can be labeled throughout the entire 360° circumference. The product is laid onto the rolls and the labeling process is started with a hand or foot switch.

Technical data	Tamp pad		
	A1021	M1021	
Material guide	left-aligned	left-aligned	centered
To be used with	SQUIX 2	SQUIX 4.3, SQUIX 4 SQUIX 4.3 M, SQUIX 4 M	
Label width	mm 25-63	25-116	25-110
Label height	mm	25-140	
Product diameter	mm	12-40	
Product surface		cylindric	
Product during labeling		in rotary motion	

# Mounting equipment for the SQUIX label printers

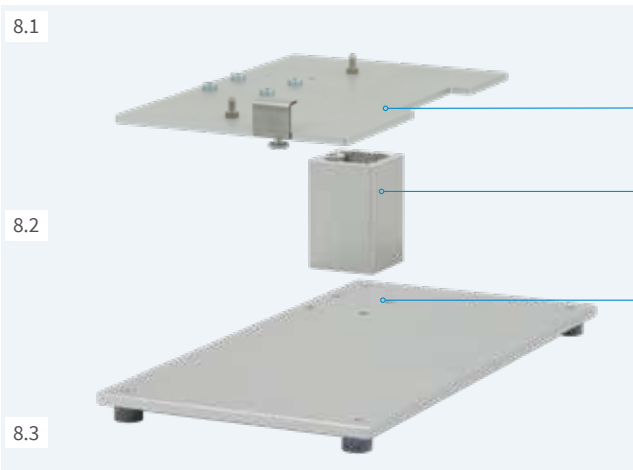

## Mounting foot

to fix the print and apply system and the product holder

- 1 **Mounting plate**  
The print and apply system is assembled on the mounting plate.
- 2 **Profile**  
Aluminum square profile, standard lengths 40, 80, 120 mm; other lengths are possible on request
- 3 **Base plate**  
to fix the product holder  
Standard size 500 x 255 mm



## Floor stand

It enables fast and flexible printer use in any production line. The labeling position is easily adjustable according to the height and width of the product. Four guide rollers provide mobility of the carriage. The floor stand is aligned with adjustable feet at the place of application.

Technical data	Floor stand	
	1600	
Total height	mm	1,600
Labeling height	up to mm	1,400
Offset to label centre	mm	230-500
Carriage Width x Height x Depth	mm	600 x 140 x 860



## Printer holder

The label printer is fixed on the mounting plate and quick-locked.

# Label printers with special covers or protection chassis

1.8



**Printers with an electrically conductive hinged cover for ESD sectors**

Available for all printer types

To protect from electrostatic charge, the cover is made of a conductive plastic. The material is very solid due to the carbon fibers and complies with the ESD standard.

If requested, also the entire casing can be designed conductive.

ESD-capable according to DIN EN 61340-5-1:2016

Surface resistance according to DIN IEC 60093  $\leq 10^4$  ohm; charge is reduced from 1,000 V to 100 V in less than two seconds

**9.1 Hinged cover as accessory**

1.9



**Printers with a detectable hinged cover for the food industry**

Available for all printer types

The cover is magnetic so that splintered parts can be detected by metal detectors and x-ray inspection systems.

The blue surface serves to distinguish more effectively from food products.

If requested, also the entire casing can be designed detectable.

The material complies with the food regulations such as EU no. 10/2011 and FDA CFR 21 177.2600.

**9.2 Hinged cover as accessory**

9.3



**Stainless steel chassis for the food industry**

Available for SQUIX 4 printers, SQUIX 6 on request

Labels are removed through the front opening.

To replace the materials, the front flap is opened and the printer is pulled out on telescopic rails. The flap is closed for steam jet cleaning.

A heater including temperature and humidity control is an option.

Protection class IP69K according to EN 60529

9.4



**Dust protection chassis for dusty surroundings**

Available for SQUIX 4 printers, SQUIX 6 on request

Labels are removed through the front opening.

The fan with the filter provides overpressure and prevents from dust entering the chassis.

Protection class IP52 according to EN 60529

**Protection chassis with extraction socket for cleanrooms on request**

## Maintenance



### Label sensor

It can be unlocked with finger pressure and pulled out for cleaning.



### Print head

Easy exchange in few simple steps. Adjustments or setups are basically not necessary.



### Print roller

It can be easily unlocked with a screw for cleaning or replacement.

### Assembly tool

ONE tool is provided with the printer to replace all components or to mount periphery.

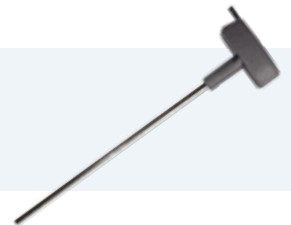

## Services

Well-trained cab service engineers worldwide support in the maintenance and repair of the devices.

Send your printer to a cab service center or a cab service partner selected by us. Your device will be checked and repaired within few workdays. If requested, a loan device will be offered.

You prefer maintenance and repair on-site in your company? Then make an appointment with our Services Department: Phone **+49 721 6626 300**, Email: [service.de@cab.de](mailto:service.de@cab.de)

## Training

Enhance your know-how on cab devices with regard to an effective use, service and repair.

In Karlsruhe we offer trainings on the handling of the devices, label design, software, printer drivers, programming, database access as well as on how to integrate in networks or superior ERP systems. We gladly send you detailed information on all our current training offers on request.

**Individually we offer trainings according to your specific demands - in Karlsruhe or on-site in your company.**



# Delivery program label printers

Pos.	Part no.	Printers with a left-aligned material guide	Part no.	Print heads	dpi	Part no.	Wear parts
1.1		<b>5977030</b> Label printer SQUIX 2/300	<b>5977384.001</b>	Print head 2	300	<b>5954102.001</b> <b>5954978.001</b>	Print roller DR2 Print roller DRS2
		<b>5977031</b> Label printer SQUIX 2/600	<b>5977385.001</b>	Print head 2	600		
		<b>5977032</b> Label printer SQUIX 2/300P	<b>5977384.001</b>	Print head 2	300	<b>5954102.001</b> <b>5954978.001</b> <b>5954104.001</b>	Print roller DR2 Print roller DRS2 Rewind assist roller RR2
		<b>5977033</b> Label printer SQUIX 2/600P	<b>5977385.001</b>	Print head 2	600		
1.2		<b>5977014</b> Label printer SQUIX 4.3/200	<b>5977382.001</b>	Print head 4.3	200	<b>5954180.001</b> <b>5954985.001</b>	Print roller DR4 Print roller DRS4
		<b>5977015</b> Label printer SQUIX 4.3/300	<b>5977383.001</b>	Print head 4.3	300		
		<b>5977001</b> Label printer SQUIX 4/300	<b>5977444.001</b>	Print head 4	300		
		<b>5977002</b> Label printer SQUIX 4/600	<b>5977380.001</b>	Print head 4	600		
		<b>5977016</b> Label printer SQUIX 4.3/200P	<b>5977382.001</b>	Print head 4.3	200	<b>5954180.001</b> <b>5954985.001</b> <b>5954183.001</b>	Print roller DR4 Print roller DRS4 Rewind assist roller RR4
		<b>5977017</b> Label printer SQUIX 4.3/300P	<b>5977383.001</b>	Print head 4.3	300		
		<b>5977004</b> Label printer SQUIX 4/300P	<b>5977444.001</b>	Print head 4	300		
		<b>5977005</b> Label printer SQUIX 4/600P	<b>5977380.001</b>	Print head 4	600		
1.3		<b>5977034</b> Label printer SQUIX 6.3/200	<b>5977386.001</b>	Print head 6.3	200	<b>5954245.001</b> <b>5954979.001</b>	Print roller DR6 Print roller DRS6
		<b>5977035</b> Label printer SQUIX 6.3/300	<b>5977387.001</b>	Print head 6.3	300		
		<b>5977036</b> Label printer SQUIX 6.3/200P	<b>5977386.001</b>	Print head 6.3	200	<b>5954245.001</b> <b>5954979.001</b> <b>5954246.001</b>	Print roller DR6 Print roller DRS6 Rewind assist roller RR6
		<b>5977037</b> Label printer SQUIX 6.3/300P	<b>5977387.001</b>	Print head 6.3	300		
Pos.	Part no.	Printers with a centered material guide	Part no.	Print heads	dpi	Part no.	Wear parts
1.4		<b>5977018</b> Label printer SQUIX 4.3/200M	<b>5977382.001</b>	Print head 4.3	200	<b>5954180.001</b> <b>5954985.001</b> <b>5953700.001</b> <b>5953701.001</b> <b>5953702.001</b>	Print roller DR4 Print roller DRS4 Print roller DR4-M25 Print roller DR4-M50 Print roller DR4-M80
		<b>5977019</b> Label printer SQUIX 4.3/300M	<b>5977383.001</b>	Print head 4.3	300		
		<b>5977010</b> Label printer SQUIX 4/300M	<b>5977444.001</b>	Print head 4	300		
		<b>5977011</b> Label printer SQUIX 4/600M	<b>5977380.001</b>	Print head 4	600		
		<b>5977022</b> Label printer SQUIX 4.3/200MP	<b>5977382.001</b>	Print head 4.3	200	<b>5954180.001</b> <b>5954985.001</b> <b>5953700.001</b> <b>5953701.001</b> <b>5953702.001</b> <b>5954183.001</b>	Print roller DR4 Print roller DRS4 Print roller DR4-M25 Print roller DR4-M50 Print roller DR4-M80 Rewind assist roller RR4
		<b>5977023</b> Label printer SQUIX 4.3/300MP	<b>5977383.001</b>	Print head 4.3	300		
		<b>5977007</b> Label printer SQUIX 4/300MP	<b>5977444.001</b>	Print head 4	300		
		<b>5977008</b> Label printer SQUIX 4/600MP	<b>5977380.001</b>	Print head 4	600		
1.5		<b>5977024</b> Label printer SQUIX 4.3/300MT	<b>5977383.001</b>	Print head 4.3	300	<b>5954180.001</b> <b>5954985.001</b> <b>5953700.001</b> <b>5953701.001</b> <b>5953702.001</b>	Print roller DR4 Print roller DRS4 Print roller DR4-M25 Print roller DR4-M50 Print roller DR4-M80
		<b>5977012</b> Label printer SQUIX 4/300MT	<b>5977444.001</b>	Print head 4	300		
		<b>5977025</b> Label printer SQUIX 4/600MT	<b>5977380.001</b>	Print head 4	600		

Pos.	Part no.	Special printers
1.8	<b>5977xxx.121</b>	Printers with a hinged cover for ESD sectors Label printer SQUIX x/xxx-ESD Label printer SQUIX x/xxxP-ESD "x" - choose device from Pos. 1.1-1.5
1.9	<b>5977xxx.122</b>	Printers with a hinged cover for the food industry Label printer SQUIX x/xxx-FOOD Label printer SQUIX x/xxxP-FOOD "x" - choose device from Pos. 1.1-1.5

x - user specific part no. following request

Scope of delivery:										
<p>Label printer Power cable Type E+F, length 1.8 m Connecting cable USB, length 1.8 m USB WLAN stick 2.4 GHz 802.11b/g/n Operator's manual DE/EN</p>										
<p><b>DVD:</b> Operator's manual in more than 20 languages Configuration manual DE/EN/FR Service manual DE/EN Spare parts list DE/EN Programming manual EN WHQL certified Windows printer drivers for</p> <table border="0"> <tr> <td>Windows Vista</td> <td>Server 2008</td> </tr> <tr> <td>Windows 7</td> <td>Server 2008 R2</td> </tr> <tr> <td>Windows 8</td> <td>Server 2012</td> </tr> <tr> <td>Windows 8.1</td> <td>Server 2012 R2</td> </tr> <tr> <td>Windows 10</td> <td>Server 2016</td> </tr> </table> <p>Apple Mac OS X printer drivers DE/EN/FR Linux printer drivers DE/EN/FR Label software cablabel S3 Lite cablabel S3 Viewer Database Connector</p>	Windows Vista	Server 2008	Windows 7	Server 2008 R2	Windows 8	Server 2012	Windows 8.1	Server 2012 R2	Windows 10	Server 2016
Windows Vista	Server 2008									
Windows 7	Server 2008 R2									
Windows 8	Server 2012									
Windows 8.1	Server 2012 R2									
Windows 10	Server 2016									



# Delivery program accessories

Pos.	Part no.	Extra equipment
2.3	<b>5977797</b> <b>5977339</b>	Antistatic brush 2" Antistatic brush 4" / 6"
2.6	<b>5959622</b>	Adapter 100
2.7	<b>5977370</b>	SD memory card 8 GB
2.8	<b>5977730</b>	USB memory stick 8 GB
2.9	<b>5977731</b>	USB WLAN stick with rod antenna 2.4 GHz 802.11b/g/n + 5 GHz a/n/ac
2.10	<b>5977732</b>	USB Bluetooth adapter
2.11	<b>5978911.597</b>	Barcode tester for linear and 2D barcodes
Pos.	Part no.	Label dispensing
2.12	<b>5977585</b>	Present sensor PS800
2.13	<b>5977538</b>	Present sensor PS900
2.14	<b>5977735</b>	Present sensor PS1000
2.15	<b>5977798</b> <b>5978908</b> <b>5977799</b>	Extended peel-off plate DP210 Extended peel-off plate DP410 Extended peel-off plate DP610
2.16	<b>5978909</b>	Product sensor with reflector
Pos.	Part no.	Interfaces
3.1	<b>5977767</b>	I/O interface
3.2	<b>5917651</b>	I/O interface connector SUB-D 25 pin
3.3	<b>5948205</b>	Label selection - I/O box
Pos.	Part no.	Connecting cable
4.1	<b>5550818</b>	Connecting cable RS232 C 9/9 pin, length 3 m
Pos.	Part no.	Cutting, perforating, stacking
5.1	<b>5979032</b> <b>5978900</b> <b>5979033</b>	Cutter CU200 Cutter CU400 Cutter CU600
5.2	<b>5978901</b> <b>5978920</b>	Perforation cutter PCU400/2,5 Perforation cutter PCU400/10
5.3	<b>5978902</b>	Stacker with cutter and base frame ST400 M
	<b>5xxxxxx</b>	Support table, label WxH





x - user specific part no. following request



Pos.	Part no.	Label rewinding, unwinding
6.1	<b>5979031</b> <b>5978903</b>	Rewind guide plate RG200 Rewind guide plate RG400
6.2	<b>5978904</b> <b>5979074</b>	From Q3/2018: External rewinder ER204 External rewinder ER206
6.3	<b>5948102.597</b> <b>5943251.597</b>	External rewinder ER1/210 External rewinder ER2/210
6.5	<b>5946090</b> <b>5946420</b>	External rewinder ER4/300 External rewinder ER6/300
6.6	<b>5946091</b> <b>5946421</b>	External unwinder EU4/300 External unwinder EU6/300
6.7	<b>5978943</b>	Adapter kit for ER4, ER6 and EU4, EU6
Pos.	Part no.	Applicators and demand modules
7.1	<b>5976086</b> <b>5976087</b> <b>5976088</b>	Applicator S1000-220 Applicator S1000-300 Applicator S1000-400
7.2	<b>5949072</b>	Universal pad A1021 70x60
	<b>5949075</b>	Universal pad A1021 90x90
	<b>59xxxxx</b> <b>5977xxx</b>	Tamp pad A1021 WxH Tamp pad M1021 WxH
7.3	<b>5949076</b>	Universal pad A1321 116x102
	<b>5949077</b>	Universal pad A1321 116x152
	<b>59xxxxx</b> <b>5977xxx</b>	Tamp pad A1321 WxH Tamp pad M1321 WxH
7.4	<b>59xxxxx</b> <b>5977xxx</b>	Blow pad A2021 WxH Blow pad M2021 WxH
7.5	<b>59xxxxx</b> <b>5977xxx</b>	Roll-on pad A1411 WxH Roll-on pad M1411 WxH

x - user specific part no. following request

# Delivery program accessories

Pos.	Part no.	Applicators and demand modules
7.6	 <b>5976085</b>	Applicator S3200
7.7	 <b>59xxxxx</b> <b>5977xxx</b>	Tamp pad A3200-1100 WxH Tamp pad M3200-1100 WxH
7.8	 <b>59xxxxx</b> <b>5977xxx</b>	Blow pad A3200-2100 WxH Blow pad M3200-2100 WxH
7.9	 <b>5976083</b> <b>5979035</b>	Demand module S5104 Demand module S5106
7.10	 <b>5976084</b>	All-around labeler

Pos.	Part no.	Mounting equipment
8.1	 <b>5979036</b> <b>5978910</b> <b>5978923</b>	Mounting plate SQUIX 2 Mounting plate SQUIX 4 Mounting plate SQUIX 6
8.2	 <b>5958365</b> <b>5965929</b> <b>5971136</b>	Profile 40 Profile 80 Profile 120
8.3	 <b>5961203</b>	Base plate 500x255
8.4	 <b>5947400</b>	Floor stand 1600
8.5	 <b>5979037</b> <b>5978922</b> <b>5979038</b>	Printer holder SQUIX 2 Printer holder SQUIX 4 Printer holder SQUIX 6

Pos.	Part no.	Special covers and protection chassis
9.1	 <b>5977771.001</b> <b>5977763.001</b> <b>5977772.001</b>	Hinged cover for ESD sectors for SQUIX 2 for SQUIX 4 for SQUIX 6
9.2	 <b>5977773.001</b> <b>5977764.001</b> <b>5977774.001</b>	Hinged cover for the food industry for SQUIX 2 for SQUIX 4 for SQUIX 6
9.3	 <b>5979071</b> <b>on request</b>	Stainless steel chassis for the food industry for SQUIX 4 for SQUIX 6
	<b>5979071.123</b> <b>on request</b>	Stainless steel chassis with heater, temperature and humidity control for SQUIX 4 for SQUIX 6
9.4	 <b>5979080</b> <b>on request</b>	Dust protection chassis for SQUIX 4 for SQUIX 6
	<b>on request</b>	Protection chassis for cleanrooms

x - user specific part no. following request

Pos.	Part no.	Label software	
11.7		<b>5588000</b> <b>5588001</b> <b>5588100</b> <b>5588101</b> <b>5588150</b> <b>5588151</b> <b>5588152</b>	cablabel S3 Lite  cablabel S3 Pro 1 WS cablabel S3 Pro 5 WS cablabel S3 Pro 10 WS cablabel S3 Pro 1 additional licence cablabel S3 Pro 4 additional licences cablabel S3 Pro 9 additional licences
		<b>5588002</b> <b>5588105</b> <b>5588106</b> <b>5588155</b> <b>5588156</b> <b>5588157</b>	cablabel S3 Print 1 WS cablabel S3 Print 5 WS cablabel S3 Print 10 WS cablabel S3 Print 1 additional licence cablabel S3 Print 4 additional licences cablabel S3 Print 9 additional licences
		in preparation	cablabel S3 Print Server
	11.10	<b>9009950</b>	Programming manual EN, printed copy

# cab product overview

**Label printers MACH1, MACH2**  
in the lower price segment



**Label printers MACH 4S**  
where little space is available



**Label printers EOS1**  
Desktop device for label rolls  
up to diameter 152 mm



**Label printers EOS4**  
Desktop device for label rolls  
up to diameter 203 mm



**Label printers SQUIX 2**  
Industrial device for print widths  
up to 57 mm



**Label printers SQUIX 4**  
Industrial device for print widths  
up to 108 mm



**Label printers SQUIX 6**  
Industrial device for print widths  
up to 168 mm



**Label printers A8+**  
Industrial device for print widths  
up to 216 mm



**Label printers XD4T**  
for double-sided printing



**Label printers XC**  
for two-color printing



**Print and apply systems Hermes+**  
for automation



**Print and apply systems Hermes C**  
for two-color printing and applying



**Print modules PX**  
to be integrated in labeling machines



**Labels**  
made from more than 400 materials



**Ribbons**  
in wax, resin and resin/wax qualities



**Label software cablabel S3**  
Design, print, control



**Label dispensers HS, VS**  
for horizontal or vertical dispense



**Labeling heads IXOR**  
to be integrated in labeling machines



**Marking lasers FL+**  
with output powers 10 to 50 Watt



**Laser marking systems XENO 1**  
for single workpieces and series





Germany  
**cab Produkttechnik GmbH & Co KG**  
Karlsruhe  
Phone +49 721 6626 0  
[www.cab.de](http://www.cab.de)

France  
**cab Technologies S.à.r.l.**  
Niedermodern  
Phone +33 388 722501  
[www.cab.de/fr](http://www.cab.de/fr)

USA  
**cab Technology, Inc.**  
Chelmsford, MA  
Phone +1 978 250 8321  
[www.cab.de/us](http://www.cab.de/us)

Mexico  
**cab Technology, Inc.**  
Juárez  
Phone +52 656 682 4301  
[www.cab.de/es](http://www.cab.de/es)

Taiwan  
**cab Technology Co., Ltd.**  
Taipei  
Phone +886 (02) 8227 3966  
[www.cab.de/tw](http://www.cab.de/tw)

China  
**cab (Shanghai) Trading Co., Ltd.**  
Shanghai  
Phone +86 (021) 6236 3161  
[www.cab.de/cn](http://www.cab.de/cn)

China  
**cab (Shanghai) Trading Co., Ltd.**  
Guangzhou  
Phone +86 (020) 2831 7358  
[www.cab.de/cn](http://www.cab.de/cn)

South Africa  
**cab Technology (Pty) Ltd.**  
Randburg  
Phone +27 11 886 3580  
[www.cab.de/za](http://www.cab.de/za)

**cab // 820 distribution partners in more than 80 countries**

**cab**  
*we identify more*