

Voxie.

Within easy reach.



Linear, contemporary design.



Simplified configuration with dip switches, push buttons and software.



Rapid and intuitive functions.



Also suitable for refurbishments.

The new line of Voxie entryphones blends in seamlessly with any architectural context.

Simple shapes, regular silhouettes, ergonomic controls and with an elegant matt white finish.

For those looking for the striking yet simple appearance and full functionality.



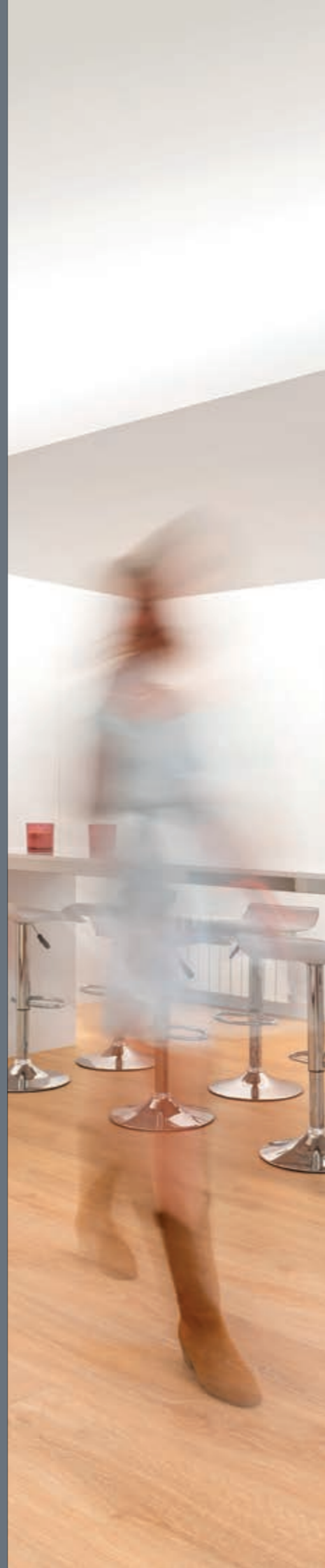
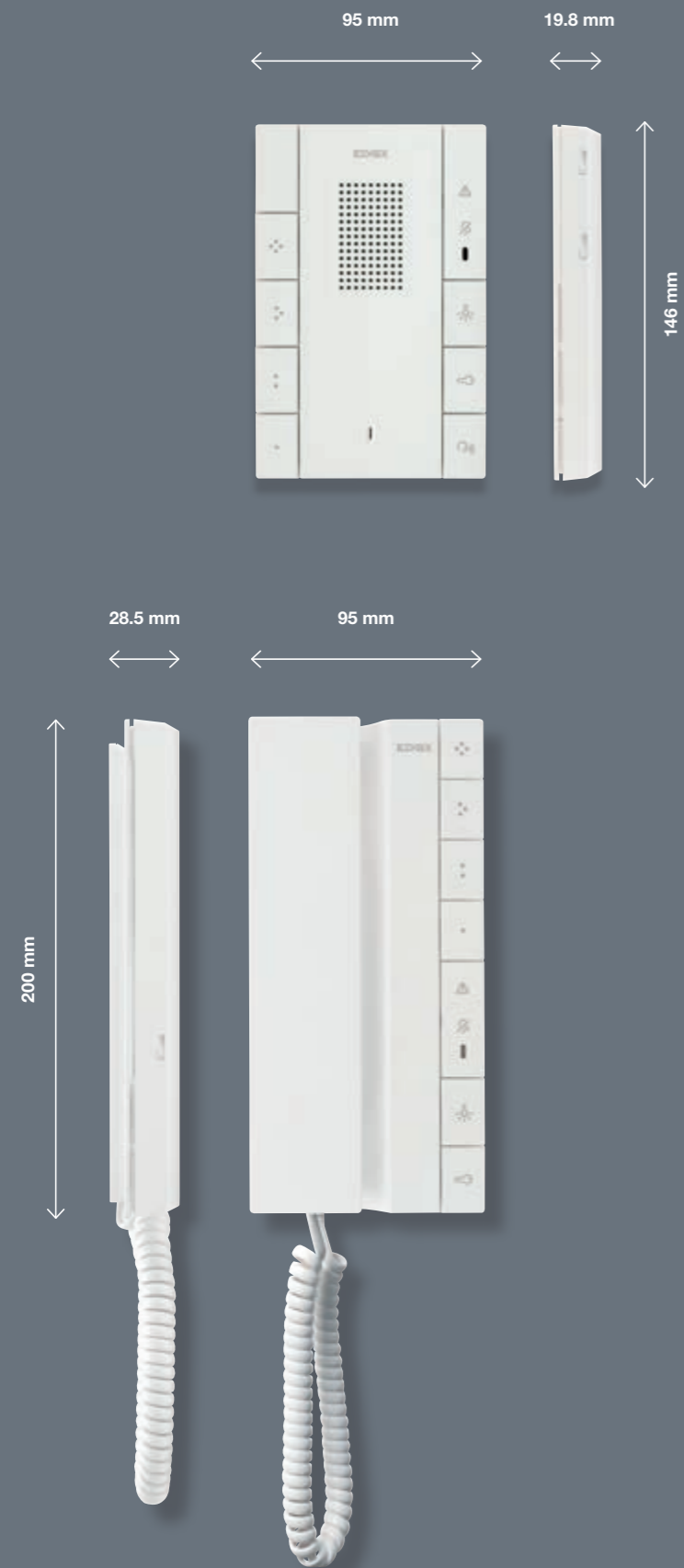

Voxie.

A complete range.



Voxie hands-free

is available for surface mounting with 7 push buttons and teleloop function.



Hands-free entryphone
7 push buttons with **Teleloop**

Voxie handset

is available for surface mounting with 2 push buttons (also in a version with teleloop) or 6 push buttons. To choose the functions to suit your individual requirements.



Entryphone with handset
2 push buttons, also with **Teleloop** version



Entryphone with handset
6 push buttons



Optical and acoustic signalling.

Crystal-clear sound and visual feedback confirm the activation of the functions, facilitating use for the visually impaired or hearing aid wearers too.



Programmable Push buttons

Talk volume control

Alert indicator

Ringtone Volume and Indicator

Auxiliary Control

Door Opening Push button
with indicator

Hands-free Push button

Push button to begin and end the conversation, with white LED signalling that the conversation is under way or that the microphone is muted (Mute function)

Voxie.

All the functions as standard.

Voxie comes complete with all functions, which can all easily be activated using the push buttons on the device. From adjusting the ringtones and the volume, to the door release button; the alert indicator and the controls which can be programmed to suit individual requirements. There is even the possibility to make intercom calls if the building has more than one indoor station, such as in service industry facilities like offices, hospitals or production departments in a factory.



Programmable Push buttons

4 programmable push buttons to suit individual daily requirements.

Auxiliary function activation push button, such as switching on the light in the entrance hall.

Audio volume and ringtone adjustment functions, also adjustable during a conversation.

Programmable melodies that can be differentiated for calls from an outdoor station, landing calls and intercom calls, depending on the models.

Lock release command sending. Thanks to the white signalling LED, in the Voxie Hands-free, if a sensor has been installed at the gate or at the main door, the door open is signalled.

Alert condition signalling, thanks to the red LED.

Voxie.

Flexible and multi-programming.
The choice is yours. Simplicity first and foremost.

For the commissioning of the indoor stations, there are **3 programming possibilities**, and one mode does not exclude the other. The instructions are the same.

New!

1. Simplified manual programming with push buttons

Manual ID code programming - (main and secondary).

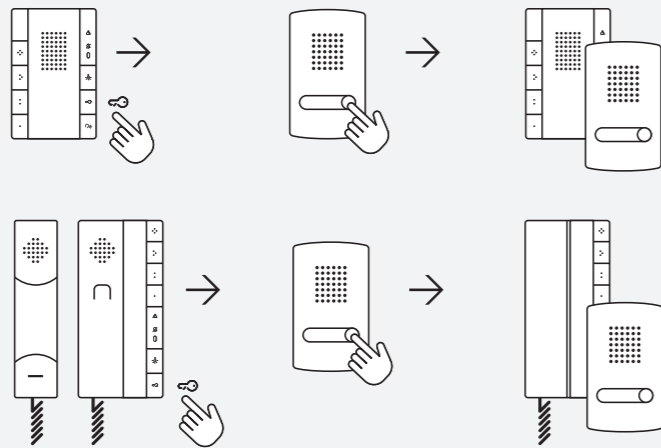

You need to intervene on the outdoor station

New!

2. Simplified programming with dip switch

Voxie is fitted with 12 switches and one "Config" push button with which to carry out all the programming.

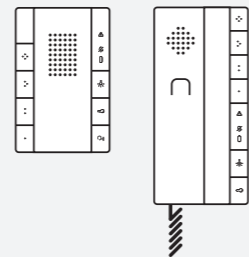

You do not need to intervene on the outdoor station

3. Programming from a PC using the software

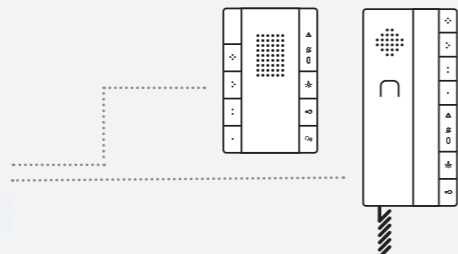

You do not need to intervene on the outdoor station

Ideal for updating or refurbishing existing systems.

Surface mounting. Super simple replacement of your old entryphone.

No need for new junction boxes. Your entryphone system is professionally set up, ready to answer, in just a few simple steps.

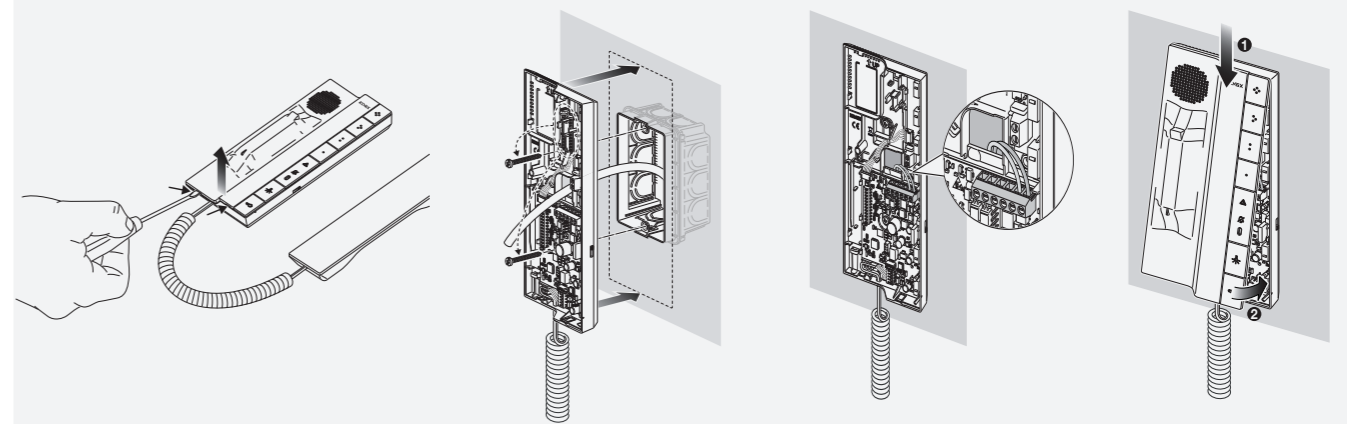

It can be surface mounted directly using wall plugs, using the Vimar flush mounting box for masonry walls or hollow walls, either round ø 60 mm or rectangular with 3 modules, or a British standard square mounting box.

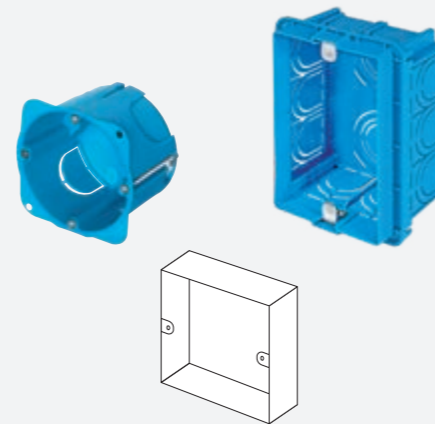

Installation in mounting box.

It can be mounted using various boxes:
- round ø 60 mm box;
- rectangular 3 vertical modules box;
- British standard square mounting box.

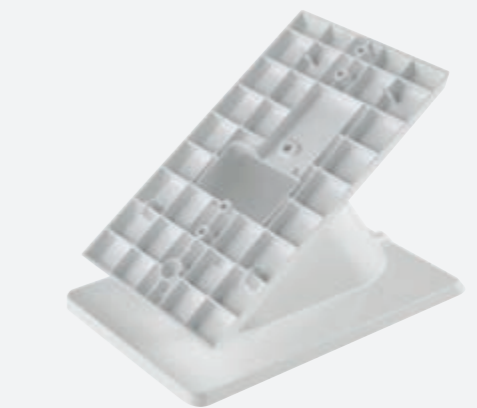

Table mounting.

Voxie can also be mounted on a dedicated optional desktop base. The ideal solution for offices or professional practices.

Voxie. All the functions as standard.
The advantage of the auxiliary functions, to communicate clearly and in an organised way.

Intercoms

Easy to communicate thanks to the intercoms function in **general** or **selective** mode.

- **General intercoms**
it makes all the indoor stations in the group ring. The first one to answer starts communicating.

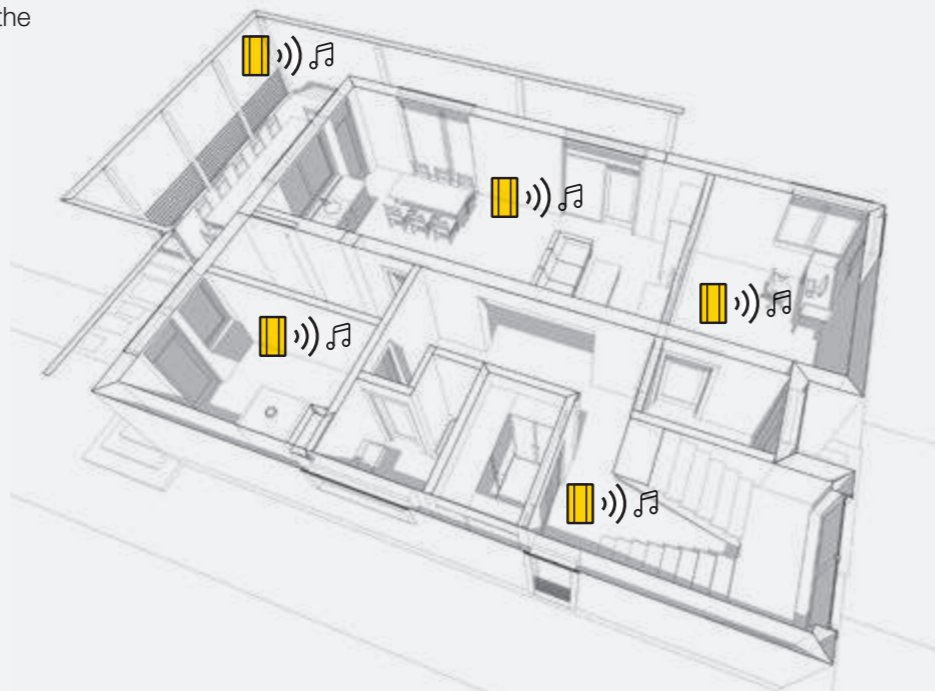

- **Selective intercoms**
allows communication with a specific indoor station within the same group.

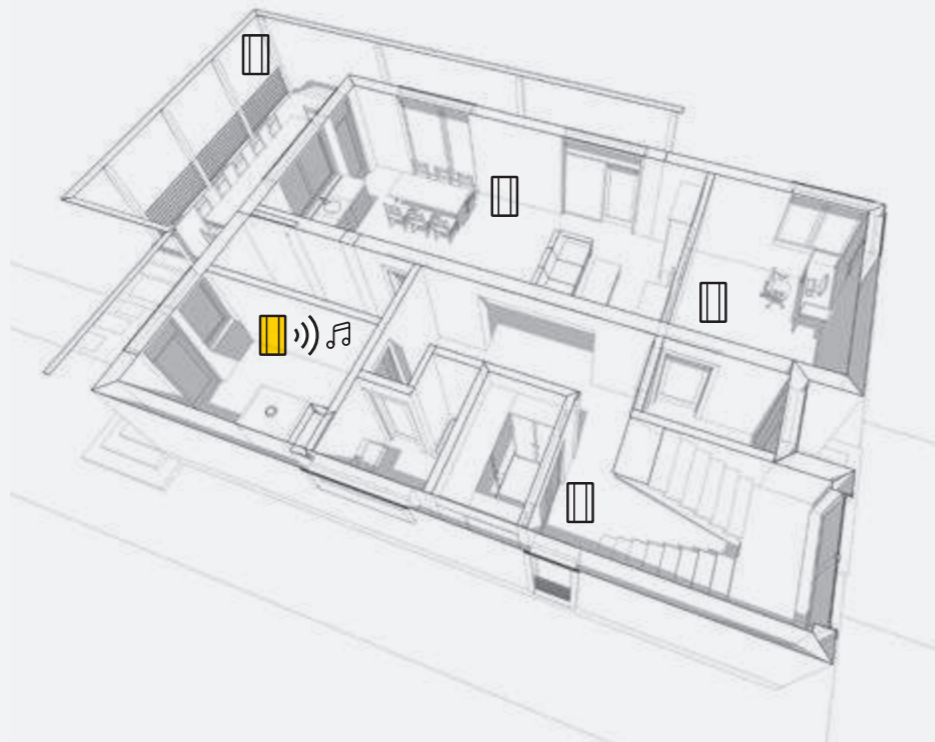

Paging

The Paging function allows all the indoor stations in a group (max 8 entryphones) to ring and to make a one-way public paging on the speaker of the Voxie hands-free entryphone. Especially useful in certain work circumstances.

To communicate simply inside companies or healthcare facilities, using the paging function or to make general announcements.

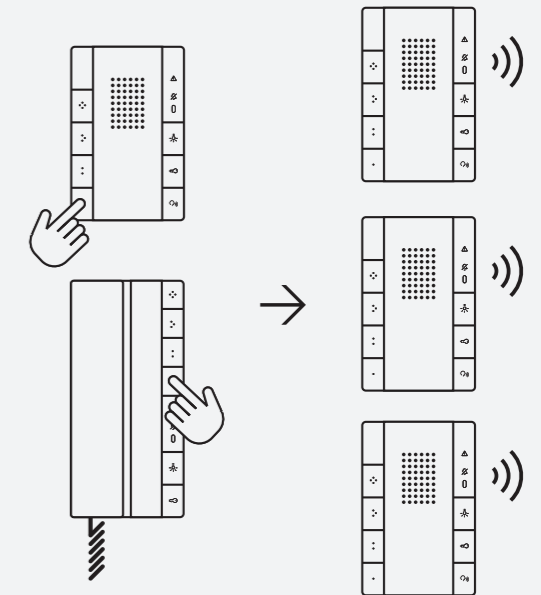
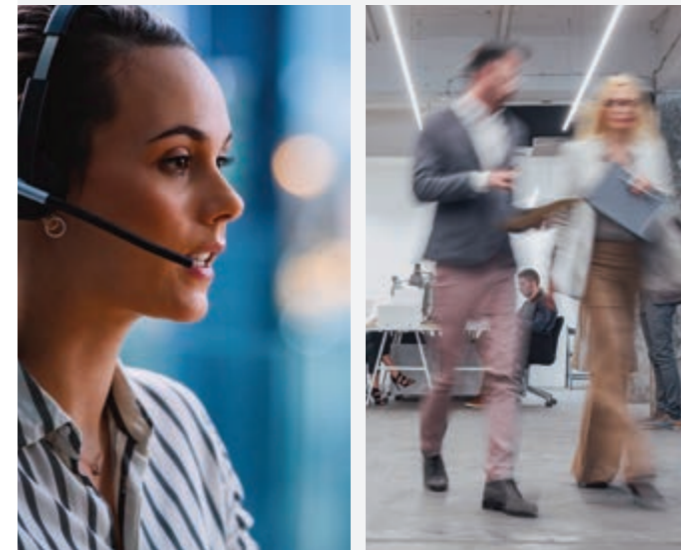

Automatic answer

Where activated, this function **allows you to talk to the caller automatically without touching the entryphone**. Useful in all those situations where you may have dirty hands or they may be otherwise engaged, such as in certain manufacturing activities or where the utmost cleanliness needs to be guaranteed, for instance in healthcare or pharmaceutical environments.

