

EDM line



EDM 310



EDM 312



EDM 313



EDM 314



EDM 316

HSC line



HSC 200



HSC 300



HSC 500



HSC 600



HSC 800

HSC MP line



HSC MP7

EDM LINE

General overview



exeron

experts in EDM + HSC

exeron GmbH
Beffendorfer Straße 6
78727 Oberndorf, Germany
Phone: +49 7423 8674-0
Fax: +49 7423 8674-112
info@exeron.de
www.exeron.de

We reserve the right to constructional changes as well as other changes to technical data and performance characteristics – provided that they serve the technical progress - errors, misprints, miscounts, misspellings and miscalculations 03/2013

exeron

experts in EDM + HSC

Even better together.

EDM and HSC from one brand.

Milling and eroding – two technologies which are more powerful when combined rather than being used on their own. exeron offers you the highest quality, made in Germany, solution for both technologies. With overall competence and a passion for perfection, we develop high tech HSC and EDM solutions as well as automated systems which suit your tasks perfectly, giving you the benefit of having only one overall-thinking partner for your tool and mould construction: exeron.

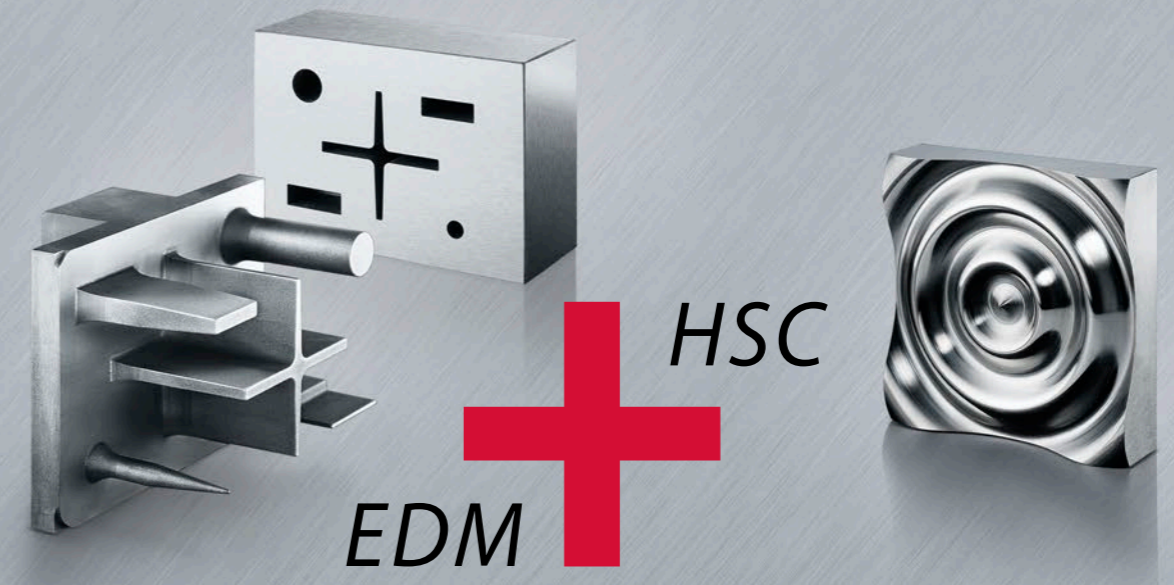

History

1966 Foundation of the third-party erosion company Herbert Walter GmbH, development work for AEG-Elotherm.

1978 First independent product – vertical erosion machine HW 100.

1981 Development of the first CNC 4-axes eroding machine. Type series 200.

1982 The first DE 10C with CNC control incl. automation, C-axis and 6-fold tool changer.

1985 Introduction of the portal eroding centre exeron 304E at EMO Hannover. Today still known as a worldwide trendsetter.

1992 Founding of DIGMA GmbH. Goal: digitalisation machine for the mould and tool production.

1995 mafell Maschinenfabrik Oberndorf (market leader in professional wood processing machines) takes over Herbert Walter GmbH as a 100% shareholder. Rebranding into Walter-exeron GmbH.

1997 First wire eroding machine D603 made in Germany at the EMO Hannover. Expansion by adding the large portal eroding centre exeron 306K.

1998 Walter-exeron GmbH obtains all rights to the Multiform Erodieretechnik GmbH (formerly Deckel Erodieretechnik). Incorporation into the newly established exeron-Multiform GmbH as a full subsidiary company.

1999 Walter-exeron and exeron-Multiform merge and become exeron GmbH; headquarters: Fluorn-Winzeln. The subsidiary Wolfratshausen remains the service and distribution centre.

2005 exeron takes over the brand DIGMA from the Chiron-Werke Tuttlingen. Supplementation of the CNC vertical erosion centres manufactured until now with a completely new type series of HSC machining centres.

2008 New factory in Oberndorf. 30 years of eroding machines and 3 years of HSC machines provided by exeron. Delivery of the first HSC machine HSC 600 entirely developed by exeron, as a 3- and 5-axis machine.

2013 35 years of erosion machines by exeron.

Content

EDM line	04
Options	10
Control	12
Automation	14
Partner	15
Application technology	16
Service	18
References	20
Customer reviews	20
Technical data	22



The small one

EDM 310 MF 30

Small, integrated, highly dynamic: we developed the EDM 310 MF 30 especially for the micro erosion in areas such as electronics and medicine technology. All process-related systems and units are fully integrated. Hence, ensuring the required installation space is extremely small.

The EDM 310 MF 30 offers you:

- > Highest stability due to FEM-optimised, undivided machine base made of mineral cast
- > Smallest installation space due to integration of all process-related systems and units
- > Digital AC servo direct drives and glass scales for highest drive and control dynamics
- > Lowerable tank, driveable while filled for free access to the workpiece
- > Fully simultaneous CNC path control MF 30 on PC basis with Windows operating system
- > High-power generator technology exopuls⁺ with Digisparc-optimised erosion process
- > Practise-oriented realisation of CE/EMC regulations
- > Connection to various automation systems possible



EDM 310 MF 30	
Traverse paths X x Y x Z	350 x 270 x 270 mm
Work table	550 x 350 mm
Work tank	770 x 520 mm
Distance table/quill min./max.	130/400 mm
Electrode weight max.	25 kg
Workpiece weight max.	500 kg
Filling height work tank	300 mm
Dimensions, total W x D x H	1,812 x 1,650 x 2,290 mm
Generator current	60 A
Mains supply	400 V, Ds, 50 Hz
Power consumption	8 kVA

Machine bed
One-piece and made of mineral cast.

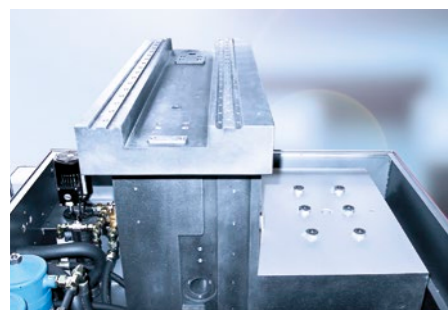

Compact design
All units are integrated into the machine base.



Z/C-axis
C-axis as rotation or erosion axis.

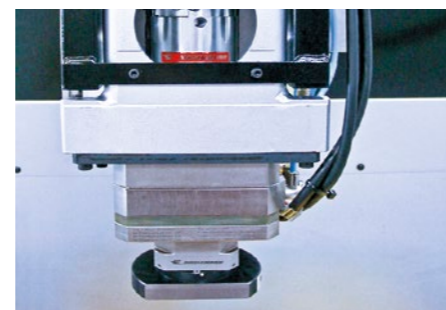

The compact one

EDM 312 MF 30

Robust, compact, versatile: the EDM 312 MF 30 is well suited for a variety of applications. Delightfully compact dimensions while still being designed for heavier loads at the Z-axis.

The EDM 312 MF 30 offers you:

- > Smallest installation space due to integration of all process-related systems and units
- > Digital AC servo direct drives and glass scales for highest drive and control dynamics
- > Lowerable tank, driveable while filled for free access to the workpiece
- > Fully simultaneous CNC path control MF 30 on PC basis with Windows operating system
- > High-power generator technology exopuls⁺ with Digisparc-optimised erosion process
- > Practise-oriented realisation of CE/EMC regulations
- > Connection to various automation systems possible
- > Chuck integrated in machine table possible



EDM 312 MF 30	
Traverse paths X x Y x Z	450 x 300 x 300 mm
Work table	820 x 400 mm
Work tank	900 x 520 mm
Distance table/quill min./max.	150/450 mm
Electrode weight max.	30/150 kg
Workpiece weight max.	800 kg
Filling height work tank	300 mm
Dimensions, total W x D x H	1,950 x 1,800 x 2,500 mm
Generator current	60 A
Mains supply	400 V, Ds, 50 Hz
Power consumption	8 kVA

X-Y-slides
Guaranteed accuracy through oversized slides and guides.



AC-Direct drive
AC-direct drive in all axes.

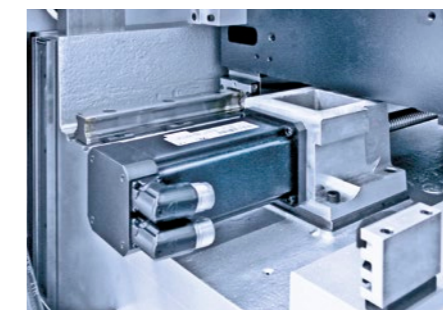

Chuck integrated into machine table
(Option)

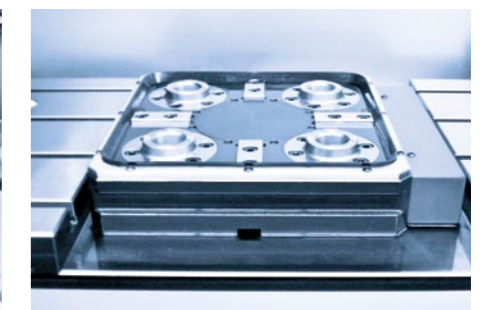



The mid-range

EDM 313 MF 30

Compact, fast, very solid: the EDM 313 MF 30 convinces with its unbeatable ratio of travel paths and installation space. The machine is also very solid while still offering high dynamics.

The EDM 313 MF 30 offers you:

- > Highest stability due to FEM-optimised, undivided machine base made of mineral cast
- > Smallest installation space due to integration of all process-related systems and units
- > Digital AC servo direct drives and glass scales for highest drive and control dynamics
- > Lowerable tank, driveable while filled for free access to the workpiece
- > Fully simultaneous CNC path control MF 30 on PC basis with Windows operating system
- > High-power generator technology exopuls⁺ with Digisparc-optimised erosion process
- > Practise-oriented realisation of CE/EMC regulations
- > Connection to various automation systems possible



EDM 313 MF 30	
Traverse paths X x Y x Z	620 x 420 x 400 mm
Work table	1,000 x 600 mm
Work tank	1,070 x 670 mm
Distance table/quill min./max.	150/550 mm
Electrode weight max.	50/250 kg
Workpiece weight max.	1,500 kg
Filling height work tank	400 mm
Dimensions, total W x D x H	2,316 x 2,430 x 2,560 mm
Generator current	60 A
Mains supply	400 V, Ds, 50 Hz
Power consumption	12 kVA

The gantry machine

EDM 314 MF 30

Powerful, flexible, ergonomic: the EDM 314 MF 30 scores with its outstanding accessibility from three sides and from the top. Large travel paths without stability losses are another feature. The drive of the machine is located in the centre of mass – this enables the highest rapid traverses.

The EDM 314 MF 30 offers you:

- > Highest stability due to FEM-optimised, undivided machine base in hybrid construction
- > Integrated dielectric system with automatic cooling for constant operating conditions
- > Digital AC servo direct drives and glass scales in the centre of mass for highest travel and control dynamics
- > Lowerable tank, driveable while filled for free access to the workpiece and short filling and emptying times
- > Fully simultaneous CNC path control MF 30 on PC basis with Windows operating system
- > High-power generator technology exopuls⁺ with Digisparc-optimised erosion process
- > Connection to various automation systems possible



EDM 314 MF 30	
Traverse paths X x Y x Z	900 x 750 x 450 mm
Work table	1,150 x 850 mm
Work tank	1,200 x 900 mm
Distance table/quill min./max.	250/700 mm
Electrode weight max.	50/500 kg
Workpiece weight max.	3,000 kg
Filling height work tank	500 mm
Dimensions, total W x D x H	2,200 x 3,416 x 3,100 mm
Generator current	60 A
Mains supply	400 V, Ds, 50 Hz
Power consumption	12 kVA

Machine bed made of mineral cast
One-piece – for highest precision.

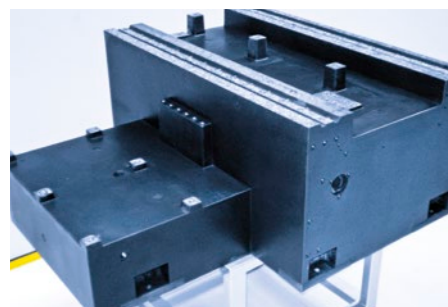

Dielectric tank
Low-maintenance due to seal-free design

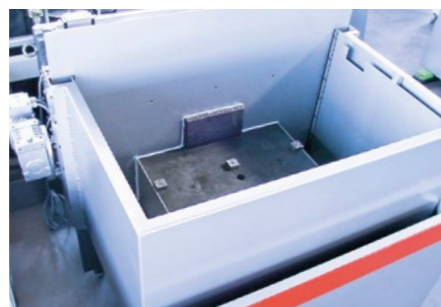

Design of the Z/Y-axis

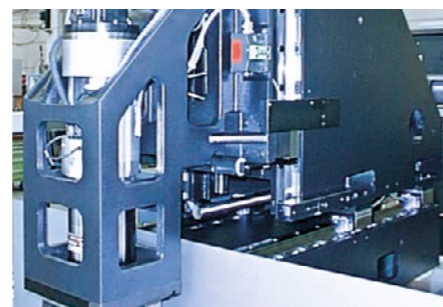

Machine base
Space-saving overall construction. Closed machine bed into which all units are integrated.

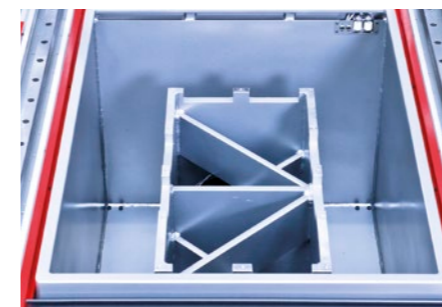

Gantry in cast construction
FEM-optimised structure for extreme stability and high dynamics.



All drives in AC-technology
The drives are directly coupled to the spindle.

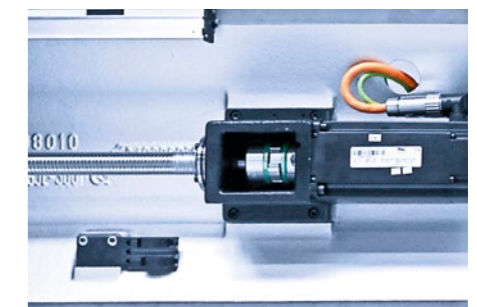

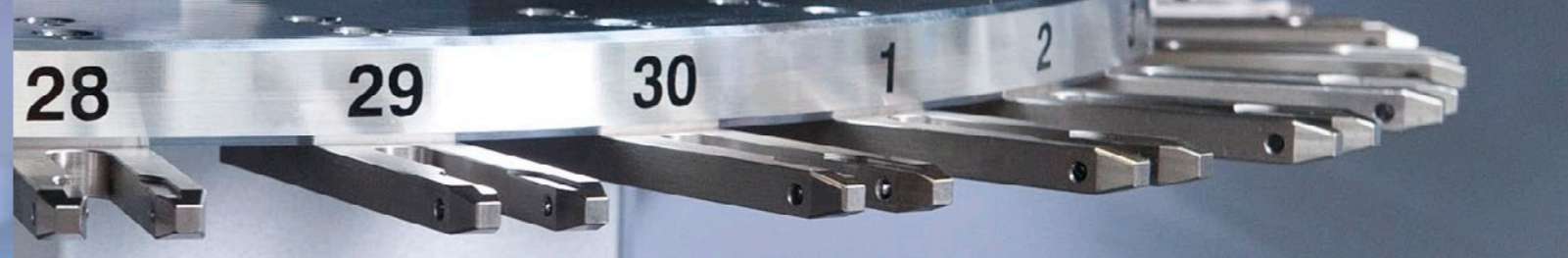

The large one with gantry

EDM 316 MF 30

Large, strong, ergonomic: the EDM 316 MF 30 is the large gantry machine for large processing tasks. Despite its size, the machine provides optimal access and offers a tank which is driveable while filled.

The EDM 316 MF 30 offers you:

- > Highest stability due to FEM-optimised, undivided machine base in hybrid construction
- > Integrated dielectric system with automatic cooling for constant operating conditions (optional: backwashing filter)
- > Digital AC servo direct drives and glass scales in the centre of mass for highest travel and control dynamics
- > Lowerable tank, driveable while filled for free access to the workpiece and short filling and emptying times
- > Fully simultaneous CNC path control MF 30 on PC basis with Windows operating system
- > High-power generator technology exopuls+ with Digisparc-optimised erosion process
- > Optimum ratio of travel paths and installation space
- > Connection to various automation systems possible



EDM 316 MF 30	
Traverse paths X x Y x Z	1,500 x 1,150 x 750 mm
Work table	1,750 x 1,350 mm
Work tank	1,800 x 1,400 mm
Distance table/quill min./max.	250/1,000 mm
Electrode weight max.	50/1,000 kg
Workpiece weight max.	8,000 kg
Filling height work tank	750 mm
Dimensions, total W x D x H	2,600 x 4,700 x 3,950 mm
Generator current	100 A
Mains supply	400 V, Ds, 50 Hz
Power consumption	18 kVA

The giant with gantry

EDM 316 XXL MF 30

Giant, strong, ergonomic: if very large is still too small, the EDM 316 XXL MF 30 comes in useful. It completes even the largest processing tasks confidently and despite its size, it provides excellent accessibility.

The EDM 316 XXL MF 30 offers you:

- > Highest stability due to FEM-optimised, undivided machine base in hybrid construction
- > Integrated dielectric system with automatic cooling for constant operating conditions (optional: backwashing filter)
- > Digital AC servo direct drives and glass scales in the centre of mass for highest travel and control dynamics
- > Lowerable tank, driveable while filled for free access to the workpiece and short filling and emptying times
- > Fully simultaneous CNC path control MF 30 on PC basis with Windows operating system
- > High-power generator technology exopuls+ with Digisparc-optimised erosion process
- > Optimum ratio of travel paths and installation space
- > Connection to various automation systems possible



EDM 316 XXL MF 30	
Traverse paths X x Y x Z	2,000 x 1,180 x 800 mm
Work table	2,500 x 1,350 mm
Work tank	2,550 x 1,400 mm
Distance table/quill min./max.	200/1,000 mm
Electrode weight max.	50/1,000 kg
Workpiece weight max.	8,000 kg
Filling height work tank	750 mm
Dimensions, total W x D x H	2,600 x 6,000 x 4,000 mm
Generator current	100 A
Mains supply	400 V, Ds, 50 Hz
Power consumption	19 kVA

Machine bed as welded construction
Grouted with mineral cast.

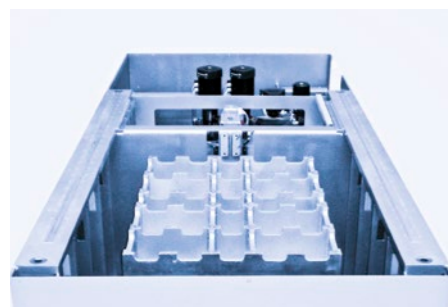

External cooling unit
For temperature stability of machine and dielectric.



Cast working table with T-slots
Continuous dielectric flushing.

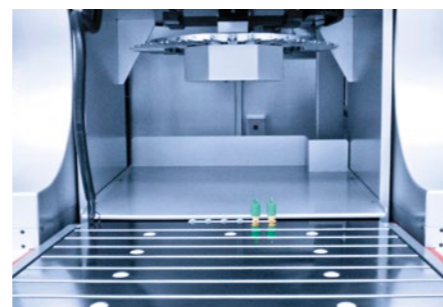

Backwashing filter
(Option)



Gantry drive in the centre of mass

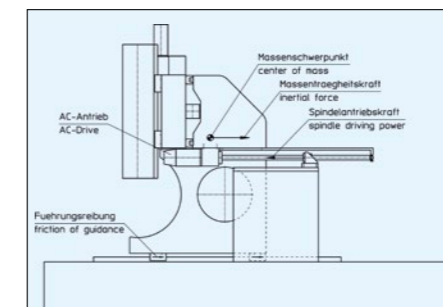

30-fold changer





Available options

Rotary/pivoting table

- > For the processing of complex components

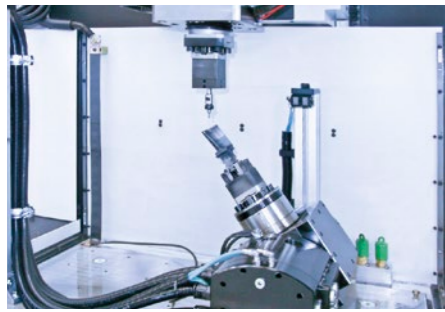

C-axis bridging

- > For large-scale and heavy electrodes, transfer of high load forces directly to the machine structure

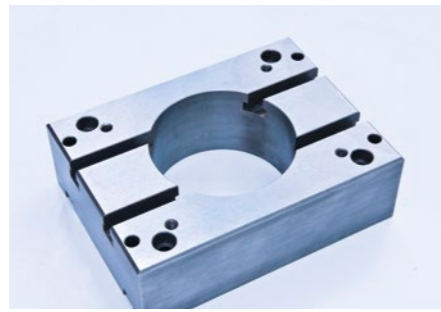

Environmentally friendly re-flushing filter system

- > 60 – 70 % less recycling costs
- > Economical advantages
- > No auxiliary filter materials
- > No downtimes
- > No maintenance



exo-call

- > Sending of important machine status messages of the machine by SMS to a user defined cell phone



exo-net

- > Connection of the eroding machine to the Internet for convenient worldwide remote monitoring from any PC, Smartphone or Tablet PC.



Connection to measuring machine

- > Connection to measuring machine for pre-setting etc.

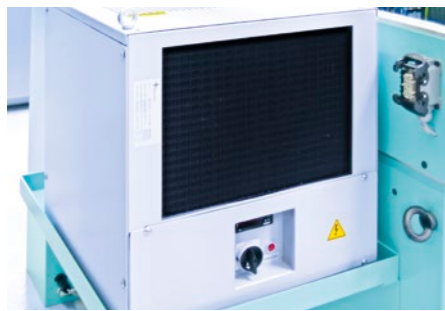
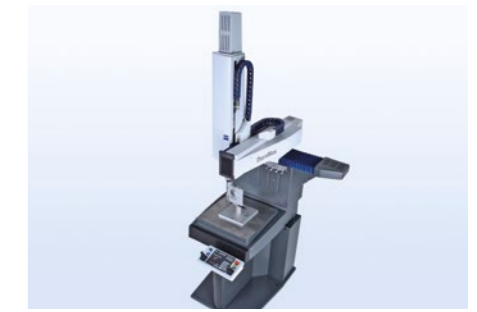

Cooling unit

- > Temperature stability of machine and dielectric
- > Constant accuracy during the entire erosion process, even for high performance



CO₂ fire extinguishing system

- > Safety during unmanned operation
- > IR-, UV-sensors for all applications



exo-prog

- > Menu-guided creation of NC programs without knowledge of the NC syntax. Graphic display of the created positions



Remote control with handwheel

- > additional display, electronic handwheel
- > Manual search into available cavities



Tool changer with ID chips

- > For reliable electrode allocation
- > Various tool changers available

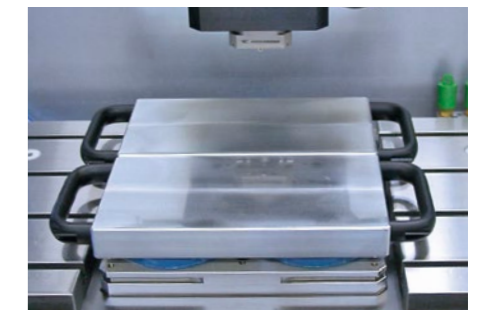

Table with automatic pallet chuck

- > For all common systems

Individual and user-friendly: the new erosion control MF³⁰

MF 30

The next generation of CNC control from the MF³⁰ range by exeron.

The new control generation MF³⁰ offers the customer a completely new operating concept based on the Metro Style, which was designed by Windows especially for touchscreen operation. The control is effected solely via touchscreen and offers completely new possibilities to the operator for the provision of the required contents. The control is similar to the Look-and-Feel control of Tablet PCs. The control leaves nothing

to be desired. It is possible to work with 6 axes simultaneously, and extensive probing cycles as well as a database for the technology selection, even the most demanding requirements, are standard.

The programming can be effected both in the NC set and menu guided. Since the hardware is based on an industrial PC, functions such as remote monitoring, network integration etc. are possible easily achieved.

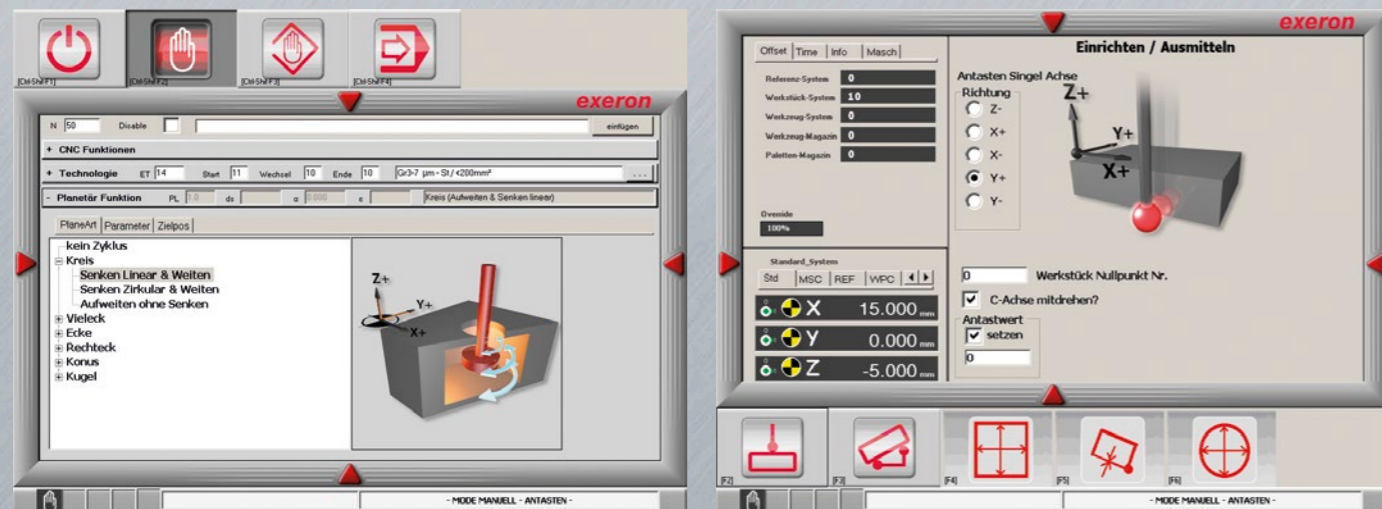

Compact and future-oriented: the generator technology exopuls⁺

exopuls⁺

In order to meet the increasing technological requirements of our customers, the exopuls⁺ generator technology enables active current shaping of the erosion pulses: an essential basis in order to keep the electrode wear during the processing at a minimum and to maximise the shaping accuracy. Furthermore, the extremely low power loss is completely dissipated by exopuls⁺.

The exopuls⁺ generator technology combines our decades of experience in the fields of EDM and generator construction. This in-house development is based on an entirely redeveloped power source design. In doing so, we put special emphasis on an extremely compact construction. It is trend-setting for the current state of technology. Another vital advantage: the new technology operates highly efficient and therefore consumes a lot less power.

Together with the process control which was developed completely in FPGA technology, it is possible to evaluate every erosion pulse at extremely short time intervals and therefore to regulate the process correspondingly. In addition, a future adjustment via software updates is ensured thanks to the extendable exopuls⁺ technology.

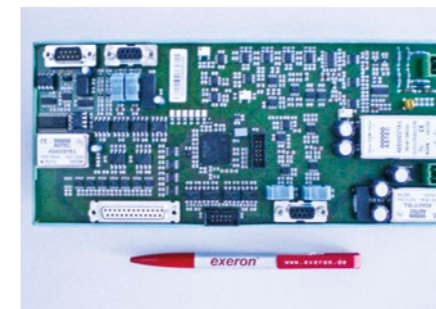

Process control
In state-of-the-art FPGA technology

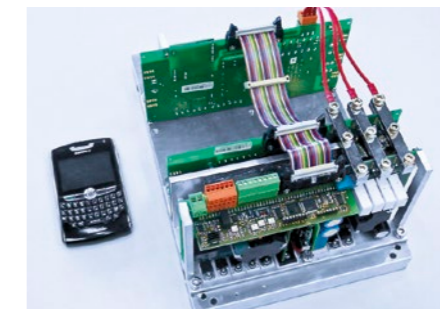

Compact generator exopuls⁺
With up to 120 A

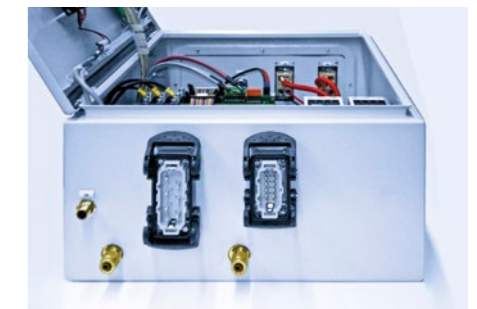

Complete generator box
Including pole-switching and cooling

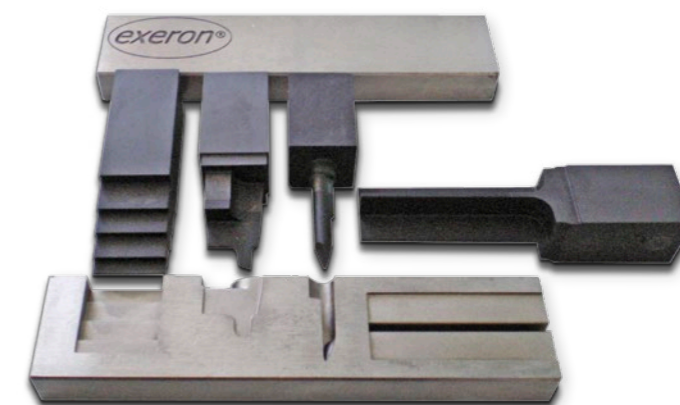

Automated systems: stay flexible for growing tasks

Automated systems by exeron create a highly powerful production cell due to the integration of additional peripherals consisting of several machines. Since the structure of the individual machines and controls is open, an automation of the machines, for example by means of electrode and pallet changer systems, is very easy. The linking of several machines via linear robot systems including the connection to a job management, measurement data or CAD system is also a clear advantage in flexibility and machine efficiency which can grow with your operational requirements.



Multi-Loader AWEX 50/5

The exeron AWEX Multi-Loader is a fully automatic electrode and pallet change system which can handle 50 electrodes and 5 pallets in the basic configuration. In the basic conception, it can be adapted to the vertical erosion machines EDM 310 to EDM 314.



AWEX 100/5

The pallet changer for all common pallets which are available on the market (EROWA, 3R, Mecatool, Hirschmann) up to a size of 320 x 320 mm. The maximum changer weight of the pallet is 60 kg; the electrode changer is designed for all systems. The AWEX 100/5 was constructed for 100 electrodes and 5 pallets.



exo-cell 150/10 ERM

This system can operate up to 2 machines. The disc configuration can be customised to customer requirements. All common electrode and pallet systems on the market can be used. The rotary magazine enables easy and very quick chip identification.



exo-cell ERSL

The complete solution when it comes to automation. ERSL is able to combine the most diverse machines and technologies. Up to 8 machines can be supplied with electrodes or pallets. All parts storages are available both as rack magazine and as rotary magazine. If required, exocell ERSL can be extended at any time.

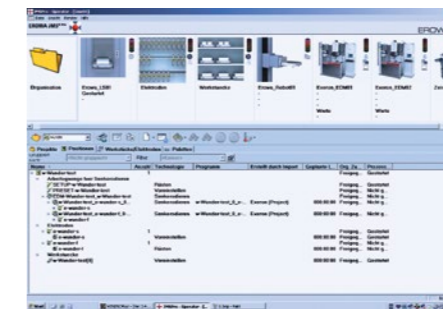

Job management

The job management controls and monitors an entire production cell. This enables an automatic, flexible production of series and individual orders without any adjustment or changeover times. All relevant production and process information is available online. Optionally with a connection of identification and CAD data takeover.



exeron partners for automation solutions



Our application technology: expertise live

Our application technology is basically the centre of our company and it is an important interface to you, our customers and potential buyers. Here, we develop and test for you new technologies, we carry out extensive tests on new strategies and if possible, we always transform the requirements of the industries into new ideas.

At the same time, our application technology is the ideal place to convince you of our capabilities. Here, we carry out test processing for you on request which will make it easier for you to decide on exeron. In doing so, the modern Zeiss measuring centre G2, which

confirms the highly precise operation of our products and which serves our own quality assurance at the same time, is facilitating our work.

Once you decided on exeron, you can gain extensive know-how within the framework of operator training in order to use your new machine optimally for your success. And later, you can extend your know-how via advanced training courses. We look forward to your visit!



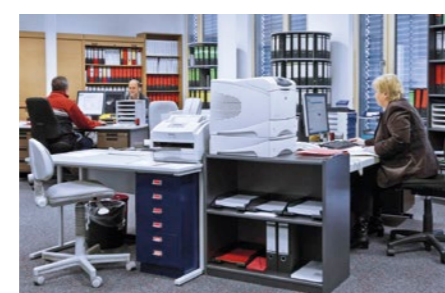
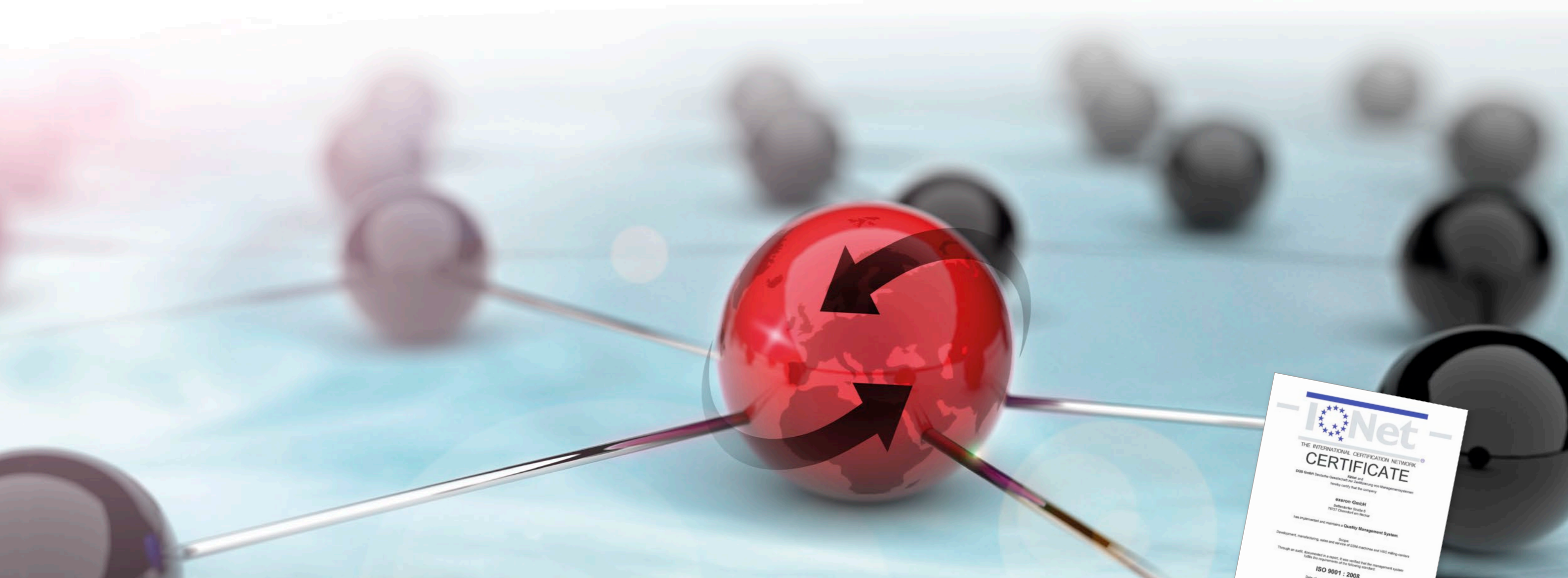

Our service: very close to you

The name exeron not only stands for well-engineered high-tech solutions, but also for a consistent and competent support in all matters of erosion technology. This ranges from the joint realisation of your requirements to a complete service. Not least because of this, machines by exeron have an excellent reputation worldwide.

For example, in case of service calls on-site, you can rely on our Germany-wide network of in-house exeron technicians who always have available many spare parts and one of which surely lives close to you. This is how we can be at your premises immediately. Additionally, we are storing thousands of other parts in a separate spare parts warehouse in Oberndorf, available to you at any time. Hence, in the worst-case scenario, a delivery is possible within 24 hours.

In addition, we offer you a remote control and remote maintenance via the Internet and for smaller requests, our telephone service is of course also happy to assist you. Furthermore, regular training courses ensure that all service technicians are always up-to-date.

Our trade partners in Europe, Asia, as well as North and South America are also efficiently supported by exeron specialists in terms of technology and service. Therefore, customers in Asia or America receive the same attention as customers in Germany and Europe.

For an overview of our partners, please see www.exeron.de/Contact/Salespartners

exeron implemented an effective quality management system which is certified to ISO 9001:2008 standard.

Happy exeron customers

Whether in Germany, Europe or elsewhere in the world: numerous renowned companies rely on the HSC solutions by exeron. And in many cases, they have been doing so for decades. Here you can read what happy customers say about exeron ...

ARaymond®



SCHAEFFLER GROUP



Avio



SULZER



ALSTOM



Anton Schweiger
(Vice President of VDWF), Schweiger GmbH & Co. KG, Uffing

“Because our company is active in large-scale mould production, we are mainly using the large gantry machines by exeron. We are now using them in the second generation and we are very happy with them. The support by the sales staff and the people in the Service Department is really exemplary.”



Father and son, Erich and Anton Schweiger

“What we value in exeron is the excellent machine range on the one hand – and the very reliable service, which always provides a solution, on the other hand. Both on the phone and on-site. This is especially important if you are operating more than ten exeron machines.”



Uwe Gunzenheimer
GKT Gräfenthaler Kunststofftechnik GmbH, Gräfenthal



Hans Keller
Manager R&D experimental workshop/
tool making, Aesculap AG, Tuttlingen

“As a manufacturer of medicine technology, we have been using various exeron vertical erosion machines for years, especially because of the tool-variety. Tuttlinger Werkzeugbau also uses the HSC milling machines by exeron/DIGMA. The big advantage of exeron is that both technologies come from one place. Therefore, our vision of the future, HSC milling, electrode measurements and sinking erosion with handling systems without interfaces, can be realised without problems. We are all very happy with the customer service and the support.”



Technical data: An overview of the EDM vertical erosion machine

	EDM 310 MF 30	EDM 312 MF 30	EDM 313 MF 30
Traverse paths X x Y x Z	350 x 270 x 270 mm	450 x 300 x 300 mm	620 x 420 x 400 mm
Work table	550 x 350 mm	820 x 400 mm	1,000 x 600 mm
Work tank	770 x 520 mm	900 x 520 mm	1,070 x 670 mm
Distance table/quill min./max.	130/400 mm	150/450 mm	150/550 mm
Electrode weight max.	25 kg	30/150 kg	50/250 kg
Workpiece weight max.	500 kg	800 kg	1,500 kg
Filling height work tank	300 mm	300 mm	400 mm
Dimensions, total W x D x H	1,812 x 1,650 x 2,290 mm	1,950 x 1,800 x 2,500 mm	2,316 x 2,430 x 2,560 mm
Generator current	60 A	60 A	60 A
Mains supply	400 V, Ds, 50 Hz	400 V, Ds, 50 Hz	400 V, Ds, 50 Hz
Power consumption	8 kVA	8 kVA	12 kVA

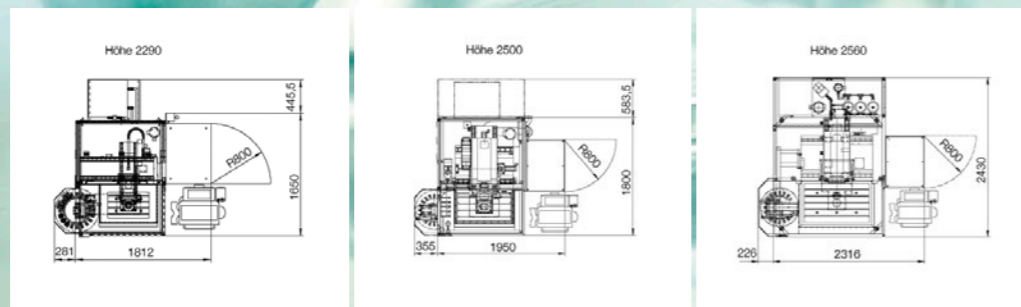

Subject to technical changes

	EDM 314 MF 30	EDM 316 MF 30	EDM 316 XXL MF 30
Traverse paths X x Y x Z	900 x 750 x 450 mm	1,500 x 1,150 x 750 mm	2,000 x 1,180 x 800 mm
Work table	1,150 x 850 mm	1,750 x 1,350 mm	2,500 x 1,350 mm
Work tank	1,200 x 900 mm	1,800 x 1,400 mm	2,550 x 1,400 mm
Distance table/quill min./max.	250/700 mm	250/1,000 mm	200/1,000 mm
Electrode weight max.	50/500 kg	50/1,000 kg	50/1,000 kg
Workpiece weight max.	3,000 kg	8,000 kg	8,000 kg
Filling height work tank	500 mm	750 mm	750 mm
Dimensions, total W x D x H	2,200 x 3,416 x 3,100 mm	2,600 x 4,700 x 3,950 mm	2,600 x 6,000 x 4,000 mm
Generator current	60 A	100 A	100 A
Mains supply	400 V, Ds, 50 Hz	400 V, Ds, 50 Hz	400 V, Ds, 50 Hz
Power consumption	12 kVA	18 kVA	19 kVA



Subject to technical changes

All vertical erosion machines by exeron with the relevant data are listed on these pages in a direct and clear comparison. We reserve the right to technical changes which serve the further development of our machines. Have you got further questions – for example regarding special requirements or regarding the implementation of individual specifications?

Then please contact us. Our experts will take the time to consult you. We look forward to talking to you.

We reserve the right to constructional changes as well as other changes to technical data and performance characteristics – provided that they serve the technical progress – errors, misprints, miscouunts, misspellings and miscalculations.