



TESA-HITE Plus M
DAS HÖHENMESSGERÄT SWISS MADE
MIT VIELFACHEN MESSFUNKTIONEN
UND HERRVORRAGENDEM PREIS/LEISTUNGSVERHÄLTNIS

Bestell-Nr.	Beschreibungen	Messspannen mm	Listenpreise €	Sonderpreise €
00730045	TESA-HITE Plus M 400	405	5049	3785
00730046	TESA-HITE Plus M 700	405	5704	3995
00730057	TESA-HITE Plus M 400 + integrierter Drucker	705	5396	4045
00730058	TESA-HITE Plus M 700 + integrierter Drucker	705	6051	4235

AUßERGEWÖHNLICHE RABATTE BIS ZU 50 %!



TESA-HITE
 ab:
 €
3785



00730045 € 3785 00730046 € 3995 00730057 € 4045 00730058 € 4235

1D ∅ ⊥ ∠ 2D Motorisiert

Fehlergrenze: 2,5 + 3L, L in m – Wiederholpräzision (2σ): 1 µm

GÜLTIG BIS 31.08.2009
 PREISE OHNE MWST.
 VERSION 04 – DE – EURO





TESATAST UND INTERAPID

TESATAST
ab:
€
65



Bestell-Nr.	Beschreibungen	Skalenteilungswert mm	Messspannen mm	Glasreif mm	Listenpreise €	Sonderpreise €
01810005	TESATAST	0,01	0,8	28	93	65
01810006	TESATAST	0,01	0,8	38	105	73
01810010	TESATAST	0,002	0,2	38	117	82
074111366	INTERAPID 312	0,01	1,6	37,5	184	129

**TESATAST +
INTERAPID
DIE WELTWEIT
BEKANNTEN
FÜLHEBEL-
MESSGERÄTE –
SWISS MADE**

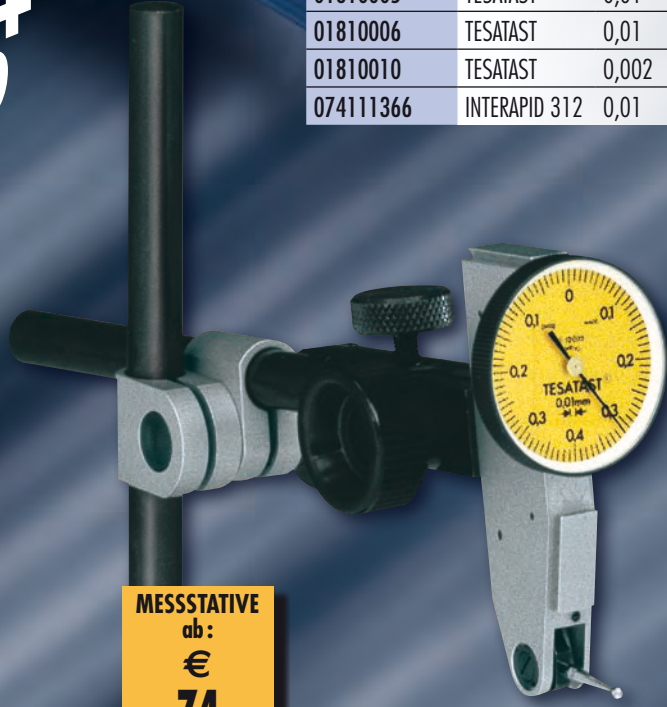

MESSSTATIVE
ab:
€
74

**MAGNETMESSSTATIVE INTERAPID
– IDEAL FÜR DEN EINSATZ MIT TESATAST**

Bestell-Nr.	Beschreibungen	Listenpreise €	Sonderpreise €
01639007	Messstativ INTERAPID UJ15	105	74
01639022	Magnetmessstativ	207	145



01639022
€ 145



**TESA DIGICO
NICHT GRÖßER
ALS EINE
MECHANISCHE
MESSUHR**

**TESA DIGICO
ab:
€
128**



TESA DIGICO, ELEKTRONISCH



01910230 € 128 01910231 € 206 01930230 € 128 01930231 € 206 01930232 € 224 01930240 € 162 01930250 € 228 01930255 € 252 01930256 € 261 01930258 € 269

Bestell-Nr.	Beschreibungen	Messspanne mm	Auflösung mm	Listenpreise €	Sonderpreise €
01910230	DIGICO 205 M, metrisch.	12,5	0,01	183	128
01910231	DIGICO 305 M, metrisch.	12,5	0,001	295	206
01930230	DIGICO 205 MI, metrisch/inch.	12,5	0,01	183	128
01930231	DIGICO 305 MI, metrisch/inch.	12,5	0,001	295	206
01930232	DIGICO 305 MIE, IP54, metrisch/inch.	12,5	0,001	320	224
01930240	DIGICO 405 MI, drehbar, metrisch/inch.	12,5	0,01	232	162
01930250	DIGICO 505 MI, drehbar, metrisch/inch.	12,5	0,001	326	228
01930255	DIGICO 505 MIE, drehbar, IP54, metrisch/inch.	12,5	0,001	361	252
01930256	DIGICO 605 MI, drehbar, max, min, max - min, Grenzwerte, metrisch/inch.	12,5	0,001	373	261
01930258	DIGICO 705 MI, für Innenmaße, drehbar, max, min, max - min, Grenzwerte, metrisch/inch.	12,5	0,001	385	269

100% DIN

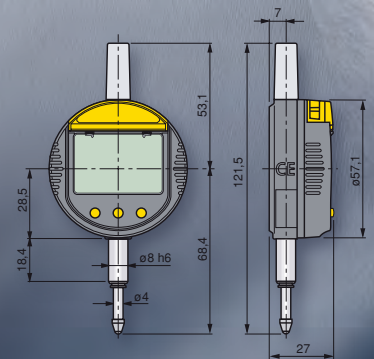



TESA
TECHNOLOGY

TESA IMICRO
VERSUCHE, SIE ZU
KOPIEREN WAREN
NIE ERFOLGREICH!



TESA IMICRO
ab:
€
189



00812304
€ 299



00812305
€ 305

EINZELGERÄTE

Bestell-Nr.	Beschreibungen	Messspannen mm	Auflösung mm	Listenpreise €	Sonderpreise €
00813410	IMICRO, analog	3,5 ÷ 4	0,001	459	275
00813411	IMICRO, analog	4 ÷ 4,5	0,001	459	275
00813412	IMICRO, analog	4,5 ÷ 5,5	0,001	462	277
00813413	IMICRO, analog	5,5 ÷ 6,5	0,001	462	277
00810001	IMICRO, analog	6 ÷ 8	0,001	315	189
00810002	IMICRO, analog	8 ÷ 10	0,001	317	190
00810003	IMICRO, analog	10 ÷ 12	0,001	319	191
00810801	IMICRO, analog	11 ÷ 14	0,005	361	217
00810802	IMICRO, analog	14 ÷ 17	0,005	365	219
00810803	IMICRO, analog	17 ÷ 20	0,005	367	220
00811501	IMICRO, analog	20 ÷ 25	0,005	398	239
00811502	IMICRO, analog	25 ÷ 30	0,005	405	243
00811503	IMICRO, analog	30 ÷ 35	0,005	410	246
00811504	IMICRO, analog	35 ÷ 40	0,005	414	248
00812301	IMICRO, analog	40 ÷ 50	0,005	475	285
00812302	IMICRO, analog	50 ÷ 60	0,005	483	290
00812303	IMICRO, analog	60 ÷ 70	0,005	494	296
00812304	IMICRO, analog	70 ÷ 80	0,005	499	299
00812305	IMICRO, analog	80 ÷ 90	0,005	508	305
00812306	IMICRO, analog	90 ÷ 100	0,005	516	310
00812601	IMICRO, analog	100 ÷ 125	0,01	730	438
00812602	IMICRO, analog	125 ÷ 150	0,01	753	452
00812603	IMICRO, analog	150 ÷ 175	0,01	771	463
00812604	IMICRO, analog	175 ÷ 200	0,01	794	476
00813101	IMICRO, analog	200 ÷ 225	0,01	1036	622
00813102	IMICRO, analog	225 ÷ 250	0,01	1069	641
00813103	IMICRO, analog	250 ÷ 275	0,01	1104	662
00813104	IMICRO, analog	275 ÷ 300	0,01	1140	684



HEXAGON METROLOGY



00811500
€ 1048

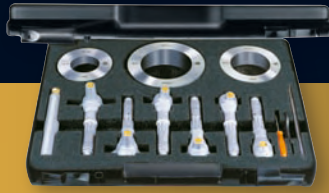

00812300
€ 1969

**INNENMESSSCHRAUBEN,
DIE DEN ABGESCHEN
GRUNDSATZ STRENG EINHALTEN -
SWISS MADE**

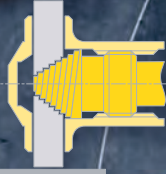

**IMICRO-Sätze
ab:
€
586**

KOMPLETTE GERÄTESÄTZE, METRISCH

Bestell-Nr.	Beschreibungen	Messspannen mm	Listenpreise €	Sonderpreise €
00813409	Satz IMICRO, analog	3,5 ÷ 6,5	1749	1049
00810000	Satz IMICRO, analog	6 ÷ 12	977	586
00810800	Satz IMICRO, analog	11 ÷ 20	1175	705
00811500	Satz IMICRO, analog	20 ÷ 40	1747	1048
00812300	Satz IMICRO, analog	40 ÷ 100	3282	1969
00812600	Satz IMICRO, analog	100 ÷ 200	3984	2390



DIE GROßEN TESA-KLASSIKER VON TESA

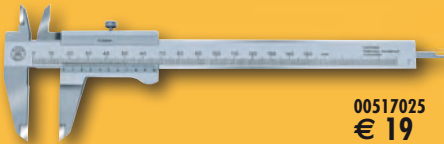

00517025
€ 19



00510004
€ 74

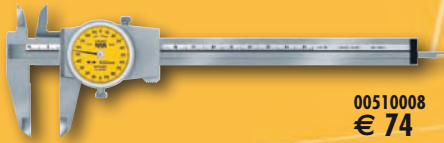

00510008
€ 74



00510050
€ 74

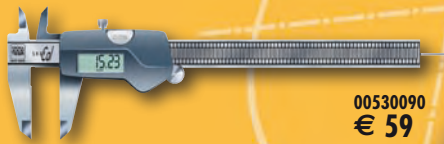

00530090
€ 59



00530300
€ 99



00530302
€ 149

Bestell-Nr.	Beschreibungen	Listenpreise €	Sonderpreise €
00517025	ROCH, 150 mm – Nonius 0,02 mm	29	19
00510004	CCMA mit Kunststoffgehäuse – 150 mm – 0,02 mm – 2 mm/Zeigerumdrehung	106	74
00510008	CCMA mit Metallgehäuse – 150 mm – 0,02 mm – 2 mm/Zeigerumdrehung	106	74
00510050	CCMA mit Metallgehäuse – 150 mm – 0,01 mm – 1 mm/Zeigerumdrehung	106	74
00530090	TESA Shop-Cal – 150 mm	99	59
00530300	TESA-CAL IP67 – 150 mm	144	99
00530302	TESA-CAL IP67 – 200 mm	223	149



MICROMASTER
ab:
€
124

CCMA
ab:
€
74

**MESSSCHIEBER UND
BÜGELMESS-SCHRAUBEN DER KLASSISCHEN
PRODUKTREIHE VON TESA – UNENTBEHRLICH,
ROBUST, LEISTUNGSFÄHIG, PREISGÜNSTIG**



Bestell-Nr.	Bügelmessschrauben MICROMASTER	Listenpreise €	Sonderpreise €
06030010	MICROMASTER EASY	207	124
06030020	MICROMASTER IP54, 0 ÷ 30 mm	239	143
06030021	MICROMASTER IP54, 25 ÷ 50 mm	293	176
06030022	MICROMASTER IP54, 50 ÷ 75 mm	335	201
06030023	MICROMASTER IP54, 75 ÷ 100 mm	382	229
	Bügelmessschrauben ETALON mit 7 Paaren wechselbarer Messeinsätze		
00219056	ETALON, 0 ÷ 25 mm	434	217
00219058	ETALON, 25 ÷ 50 mm	447	224
00219060	ETALON, 50 ÷ 75 mm	505	253
00219062	ETALON, 75 ÷ 100 mm	518	259



06030010
€ 124



06030020
€ 143



06030021
€ 176



06030022
€ 201



06030023
€ 229

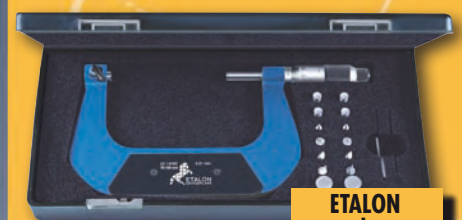

ETALON
ab:
€
217



TESA-CAL
ab:
€
99



TESA DUO-SET

DIE MARKTFÜHRENDEN
GERÄTESÄTZE – SWISS MADE

DIE REFERENZ
FÜR JEDEN LEHRLING!

TESA DUO-SET
ab:
€
182



Bestell-Nr.	Beschreibungen	Listenpreise €	Sonderpreise €
00531006	TESA Duo-Set 15 – 1 Messschieber TESA-CAL IP67/RS – 1 Tiefenmessanschlag – 1 Bügelmessschraube MICROMASTER IP54/RS – 1 Etui	460	276
00530021	TESA Duo-Set 2 – 1 Messschieber TESA CCMA-M – 1 Tiefenmessanschlag – 1 Bügelmessschraube TESAMASTER – 1 Etui	304	182



00530021
€ 182

TESA SA Switzerland
Bugnon 38
CH-1020 Renens

Tél. +41 (0)21 633 16 00
Fax +41 (0)21 633 17 57
tesa-ventsch@hexagonmetrology.com

TESA FRANCE SAS
13-15, av. Georges de La Tour
F-54303 Lunéville Cedex

Tél. +33 (0)3 83 76 83 76
Fax +33 (0)3 83 74 13 16
tesa-france@hexagonmetrology.com

**TESA Technology
Deutschland GmbH**
Netzstraße 32
D-71638 Ludwigsburg
Tel. +49 (0)7141 8747 0
Fax +49 (0)7141 8747 88
tesa-de@hexagonmetrology.com

TESA Technology UK Ltd.
Metrology House
Halesfield 13
GB-Telford, Shrops. TF7 4PL
Tel. +44 1952 681 349
Fax +44 1952 681 391
tesa-uk@hexagonmetrology.com

TESA Technology ITALIA s.r.l.
Via Bizzozzero, 118
IT-20032 Cormano (MI)

Tel. +39 02 663 053 69
Fax +39 02 663 090 82
tesa-italia@hexagonmetrology.com

TESA Technology Ibérica
Av. de Vizcaya s/n
Apart. 202
ES-48260 Ermua
Tel. +34 943 170 340
Fax +34 943 172 092
tesa-iberica@hexagonmetrology.com

TESA Benelux
Pascal Siebens
G^{de} de Wittelaan 17, Bus 21
BE-2800 Mechelen
Tel. +32 (0)15 435 301
Fax +32 (0)15 435 302
tesa-benelux@hexagonmetrology.com

Hexagon Metrology Nordic AB
Filargatan 3

SE-631 81 Eskilstuna
Tel. +46 16 160800
Fax +46 16 160890
info.se@hexagonmetrology.com

Hauptsitz: TESA SA – Bugnon 38 – CH-1020 Renens – Switzerland – Tel. +41(0)21 633 16 00 – Fax +41(0)21 635 75 35 – www.tesabs.ch – tesa-info@hexagonmetrology.com



SWISS MADE
HEXAGON METROLOGY

In der Schweiz gedruckt – Änderungen vorbehalten – 10011.046.0904 – Version 04