

CONEC®

TECHNOLOGY IN CONNECTORS™

PCB CONNECTORS

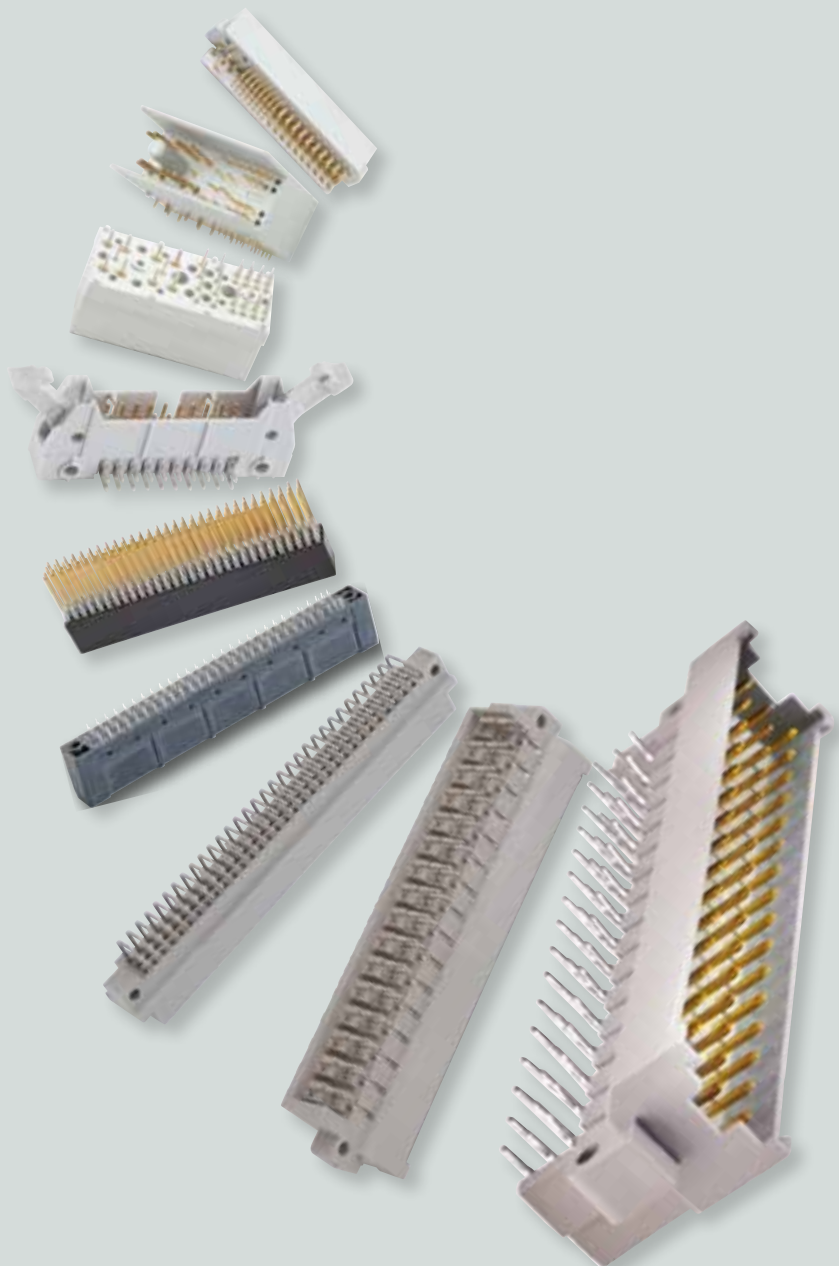

CONEC[®]

TECHNOLOGY IN CONNECTORS[™]



GERMANY

As a leading manufacturer of connectors, CONEC develops, produces and markets its products around the world to customers in the machine-tool, electronics and communications industries.

CONEC has dedicated itself to make a contribution to progress in the connector industry and to satisfy its customers through innovation, quality and excellent service. Around the world, our organization operates as a customer-oriented team.

CONEC is present in numerous countries with its own branch offices and representatives. Our local sales consultants transmit all information directly to the responsible departments to keep the paths of communication short. This provides support in the local language, quick response and competent consulting.

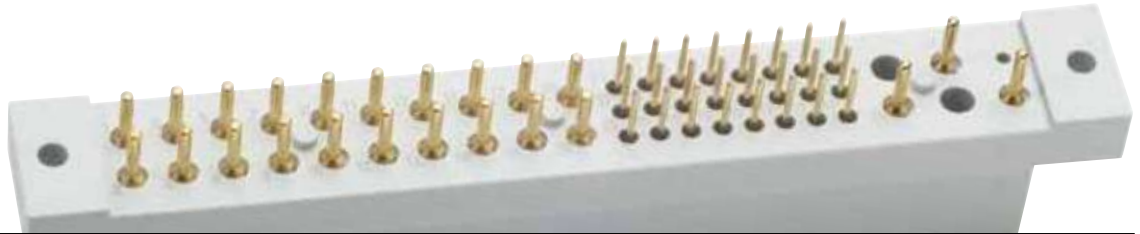

CANADA



USA

CONEC designs and manufactures products in modern facilities. The products are made in accordance to the highest quality standards and industry specifications.

CONEC provides reliable and effective solutions to OEM, EMS and cable houses.



OUR PHILOSOPHY – CUSTOMER SATISFACTION.



Quality is realized right from the beginning with Total Quality Management concept. Therefore our customers are included into all our processes, starting with design phase, first sampling, series production release and continuous sales support. The phases will be accompanied by drawings, samples and test reports. The entire quality process is documented and approved. CONEC is certified to ISO/TS16949:2002.

CONEC inhouse is equipped with modern test systems. We can verify the requirements and implement a continuous product improvement process to meet and exceed future requirements. To fulfill international and national requirements most of CONEC product series are registrated by UL, CSA or VDE.



CONEC IS YOUR SPECIALIST FOR DESIGN AND PRODUCTION OF SPECIAL CUSTOMIZED PRODUCTS.

Flexibility, assurance and rapid response are required in today's market more than ever before. CONEC fulfills these demands with central order-processing and well implemented quality control systems. Statistical process control as well as just in time deliveries are a common practice. Numerous customers honored this performance by approving CONEC to a "Preferred Supplier" status.



Are you looking for application-specific solutions?
Standard products do not meet your needs?
The implementation deadline is tight?

CONEC experienced design team can create your solution for you:

- Special Interconnect solutions to customers specifications
- Prototypes and small series production batches
- Connectors with increased IP ratings for harsh environments.

Contact us to discuss your special requirements.

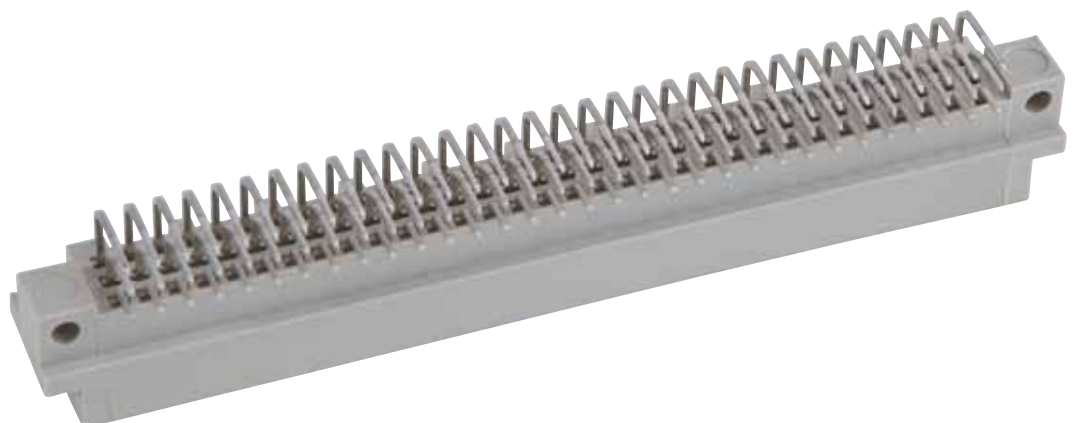

PRODUCT LINES



I/O Connectors

D-SUB Connectors, Standard, Combination and Water Resistant; D-SUB Hoods and D-SUB accessories; Filter D-SUB Connectors, Standard, Combination and Water Resistant; Filter Adapters; Filter Plates; RJ45-IP67 Industrial Ethernet Connector System; USB 2.0-IP67 Connector System; RJ45 Magnetic Modular Jacks



PCB Connectors

DIN 41617 Connectors; DIN EN 60603-2 Connectors; DIN 41651 Insulation Displacement Connectors CompactPCI Connectors; AdvancedTCA Connectors; MicroTCA Connectors; PC104-, PC104plus Connectors; Pin Header and Socket Connectors



Sensor Actor Line / Circular Connectors

M12x1 Connectors, Overmolded and Field Attachable, Sockets, Junction Boxes, M12x1 Connector Systems for High Temperature, Food+Beverage, Bus Systems; M8x1 Overmolded Connectors; 7/8" Connectors; Rund24 Connectors; Valve Connectors



Fiber Optic Connectors











Adapter; Hybrid Adapter; Outdoor Connectors; Patch cords



Coaxial Connectors

SMA, SSMA, MMCX, TNC, N, MCX, Mixed Adapters and BNC Connectors; D-SUB and DIN Coaxial Contacts; D-SUB and DIN High-Current Contacts

INDEX

<p>SECTION 1 AdvancedTCA Connectors _____</p>	
<p>SECTION 2 MicroTCA Connectors _____</p>	
<p>SECTION 3 CompactPCI Connectors _____</p>	
<p>SECTION 4 Connectors DIN EN 60603-2 (DIN 41612) _____</p>	
<p>SECTION 5 Combination Connectors DIN EN 60603-2 (DIN 41612) _____</p>	
<p>SECTION 6 PC104 and PC104plus Connectors _____</p>	
<p>SECTION 7 Connectors DIN 41617 _____</p>	
<p>SECTION 8 Flatcable Connectors DIN 41651 _____</p>	
<p>SECTION 9 Installation and Assembly Tools _____</p>	
<p>SECTION 10 Part Numbers _____</p>	



665800 75
665895 77

SECTION 1

ADVANCEDTCA CONNECTORS

This newly developed architecture and system layout allows manufacturers of telecom equipment a new standard for designing systems (PICMG 3.0). ATCA stands for: Advanced Telecommunications Computing Architecture

The basic structure is utilizing a modular concept. Application of this new structured approach allows various module designs that are compatible in layout and mechanical installation.

CONEC manufactured the power connectors for the ATCA-System which are used in Zone 1.

Advanced TCA[®]





The PICMG Group created the PICMG 3.0 Standard. This Standard specifies the mechanical details with regards to input/output, voltage, current and connection parameters. Control, backplane layout and system architecture are part of the standard.

CONEC has developed a new family of connector products that adhere to this new Standard. Products such as plugs and sockets, high power and signal contacts, have been developed.

This new connector series is available with press fit and through hole contact types.

Product features:

- Rugged construction
- Polarizing system
- Premating contacts
- Press fit contacts ("Eye of the needle")
- Selective loading of contact positions
- Screwdown hardware
- Special variations on request

CONEC is member of the PICMG Group.
For more information please visit
www.picmg.com.



TECHNICAL DATA

Materials	Precision machined contacts	Stamped contacts
Insulator	Glass filled plastic, UL 94V-0	
Contacts		
Materials	Copper alloy	
Plating	Gold flash over nickel / 0.8 µm gold over nickel (press fit design tin plated)	Gold flash over nickel / 0.8 µm gold over nickel gold over nickel (press fit design tin plated)

Electrical Characteristics	
Max. current rating, per UL 1977, (see temperature rise curve for details)	
Size 16 power contacts	30 A continuous all contacts under load
Size 22 signal contacts	2 A nominal rating
Initial contact resistance (termination to termination)	
Size 16 power contacts	0.0022 Ω max.
Size 22 signal contacts	0.0085 Ω max. 0.02 Ω max.
Insulation resistant	5 G Ω per IEC 512-2 Test 3a
Voltage proof	
Contacts 1 through 16	1000 V r.m.s.
Contacts 17 through 34	2000 V r.m.s.
Creepage and clearance distance (minimum)	
Contact positions 1 through 16 to any other contact within this group	0.7 mm
Contact positions 17 through 24 to any other contact within this group	2.5 mm
Contact positions 25 through 34 to any other contact within this group	1.4 mm
Contact positions 13 through 16 to 17 through 20	3.0 mm
Contact positions 21 through 24 to 25, 26	4.0 mm
Contact positions 25, 26 to 27 through 29	2.0 mm
Working voltage	100 V r.m.s.

Mechanical Characteristics	
Blind mating system	male and female connector bodies provide "lead-in" for 2.0 mm diametral misalignment
Polarization	provided by connector body design
Resistance to solder heat	260°C for 10 seconds duration per IEC 512-6, Test 12e 25-watt soldering iron (for other application contact factory)
Sequential contact mating system (succession)	<ol style="list-style-type: none"> 1. 25, 26, 28, 29, 30 and 31 2. 33 3. 34 4. contacts 1 to 24 mate before 27 and 32 (last mate)
Mechanical operations	250 cycles
Temperature range	-55°C to +125°C

Technical alterations are subjects to change without notice.

DIAGRAM

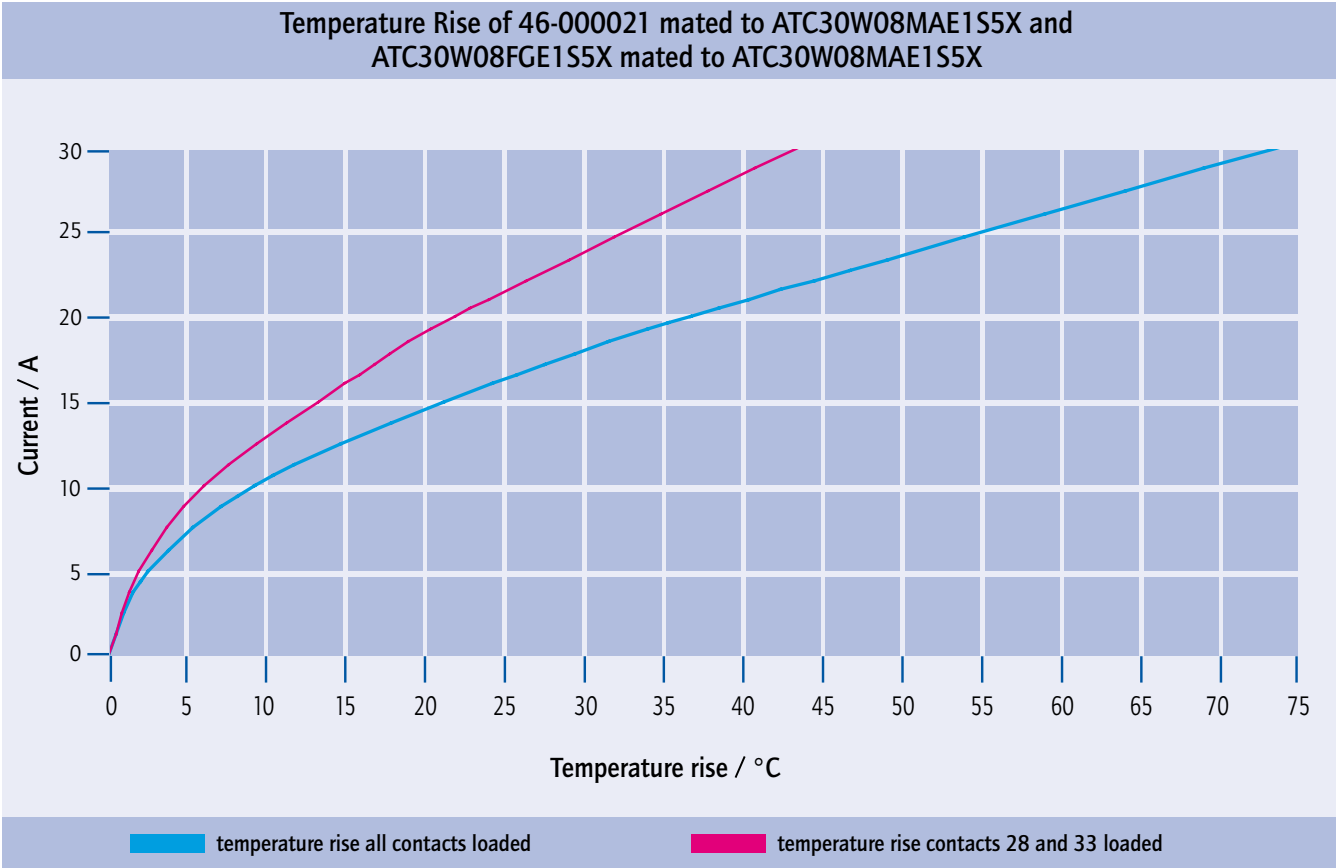

ADVANCEDTCA

Male Connector – angled – press fit – precision machined contacts

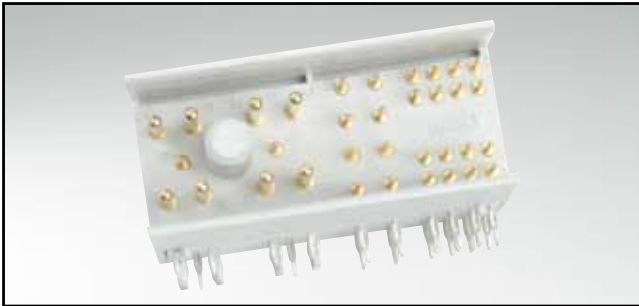

RoHS compliant – UL listed, File no.: E228329

DESCRIPTION

- Signal and power contacts
- Alternatively 22, 30 or 34 positions
- Eye of the needle press fit design, tin plated
- Precision machined contacts for mating area
- Mating area: gold plated quality class 1 or alternative quality class 3
- Special contact loadings possible on request

PRODUCT DRAWING

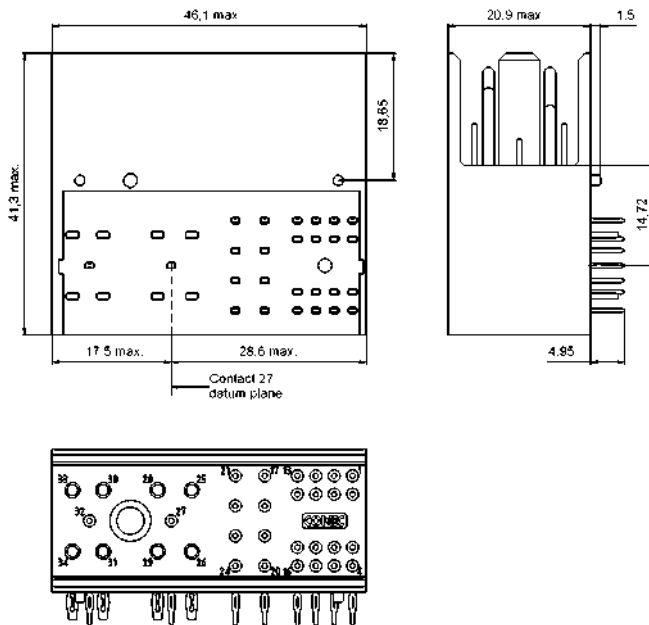

PCB-hole pattern (34 positions)

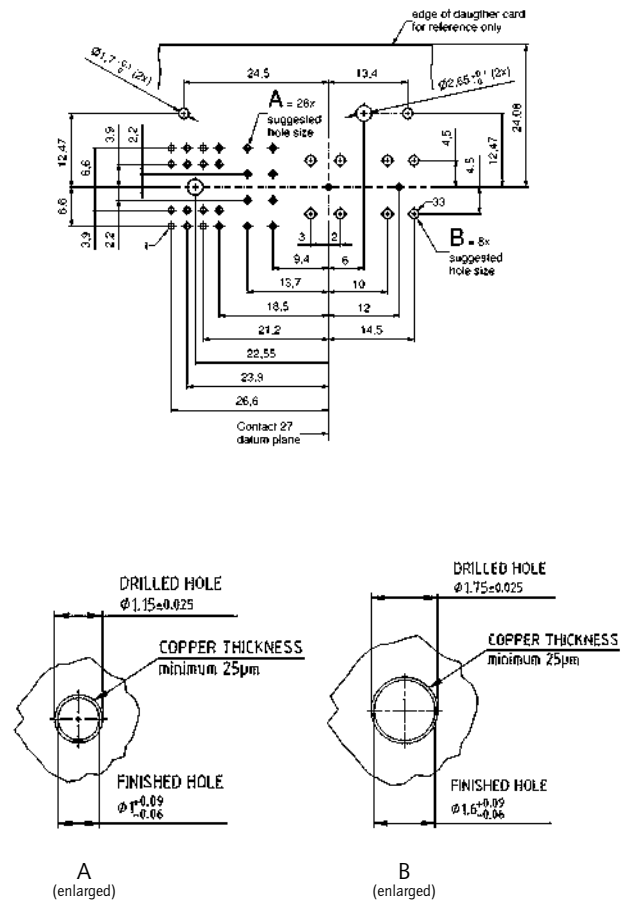

ORDER DATA

(Dim. = mm)

Number of positions	Contacts	Part number Quality class 3 (gold flash)	Part number Quality class 1 (0,8µm Au mating area)
22	14x signal / 8x power	ATC22 W08 MAE3S5 X	ATC22 W08 MAE1S5 X
30	22x signal / 8x power	ATC30 W08 MAE3S5 X	ATC30 W08 MAE1S5 X
34	26x signal / 8x power	ATC34 W08 MAE3S5 X	ATC34 W08 MAE1S5 X

ADVANCEDTCA

Female connector – straight – press fit – precision machined contacts



RoHS compliant – UL listed, File no.: E228329

DESCRIPTION

- Signal and power contacts
- Alternatively 22, 30 or 34 positions
- Eye of the needle press fit design, tin plated
- Precision machined contacts for mating area
- Mating area: gold plated quality class 1 or alternative quality class 3
- Special contact loadings possible on request

PRODUCT DRAWING

PCB-hole pattern (34 positions)

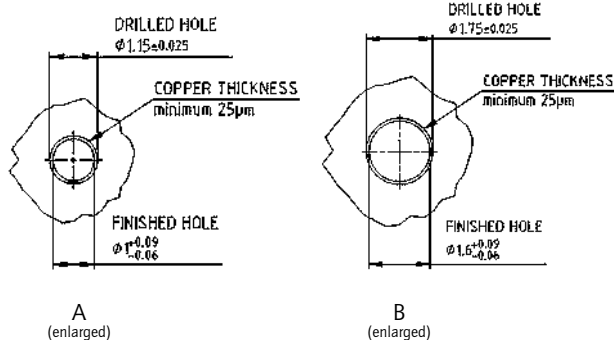
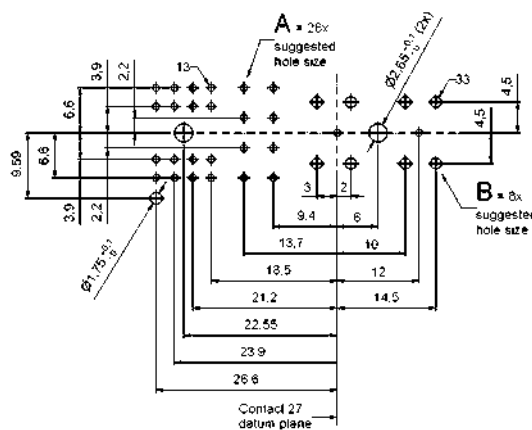
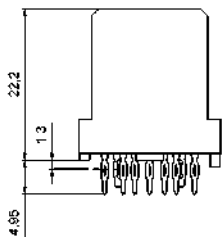
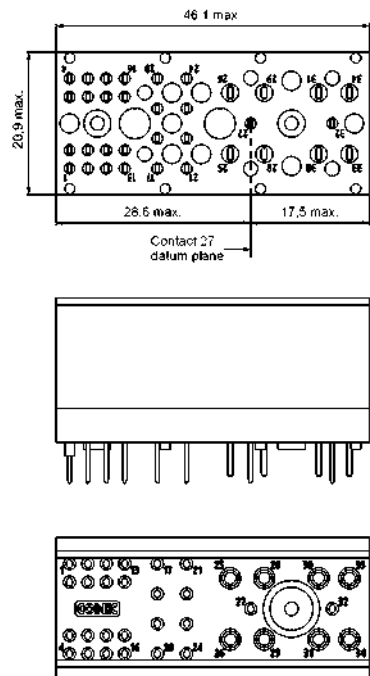

ORDER DATA

(Dim. = mm)

Number of positions	Contacts	Part number Quality class 3 (gold flash)	Part number Quality class 1 (0,8µm Au mating area)
22	14x signal / 8x power	ATC22 W08 FGE3S5 X	ATC22 W08 FGE1S5 X
30	22x signal / 8x power	ATC30 W08 FGE3S5 X	ATC30 W08 FGE1S5 X
34	26x signal / 8x power	ATC34 W08 FGE3S5 X	ATC34 W08 FGE1S5 X

ADVANCEDTCA

Male connector – angled – solder pin – precision machined contacts

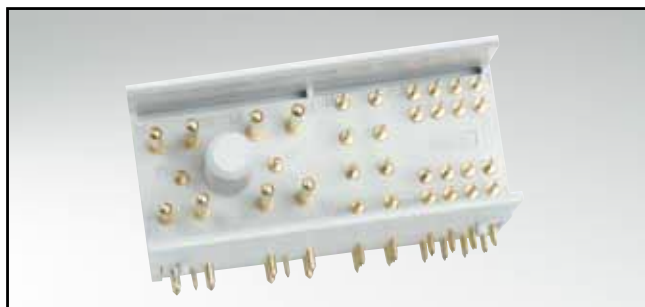

RoHS compliant – UL listed, File no.: E228329

DESCRIPTION

- Signal and power contacts
- Alternatively 22, 30 or 34 positions
- Mating area: gold plated quality class 1 or alternative quality class 3
- Special contact loadings possible on request

PRODUCT DRAWING

PCB-hole pattern (34 positions)

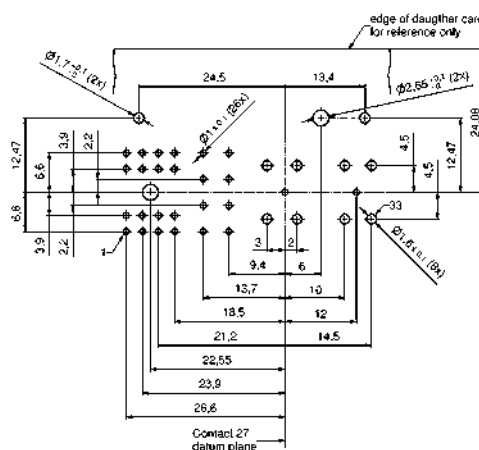
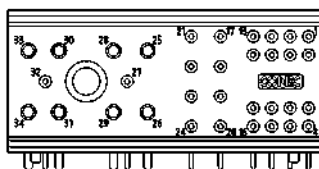
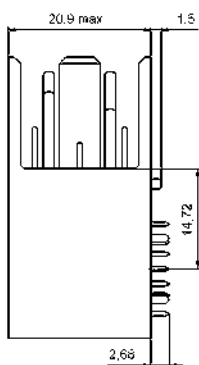
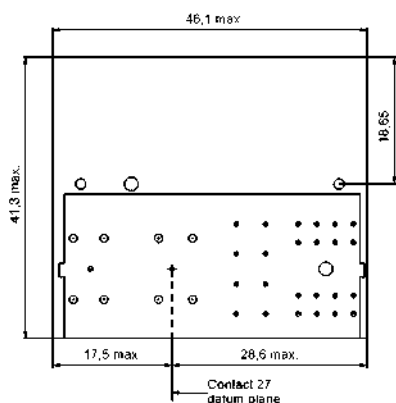

ORDER DATA

(Dim. = mm)

Number of positions	Contacts	Part number Quality class 3 (gold flash)	Part number Quality class 1 (0,8µm Au mating area)
22	14x signal / 8x power	ATC22 W08 MARAS5 X	ATC22 W08 MARCS5 X
30	22x signal / 8x power	ATC30 W08 MARAS5 X	ATC30 W08 MARCS5 X
34	26x signal / 8x power	ATC34 W08 MARAS5 X	ATC34 W08 MARCS5 X

ADVANCEDTCA

Female connector – straight – solder pin – precision machined contacts

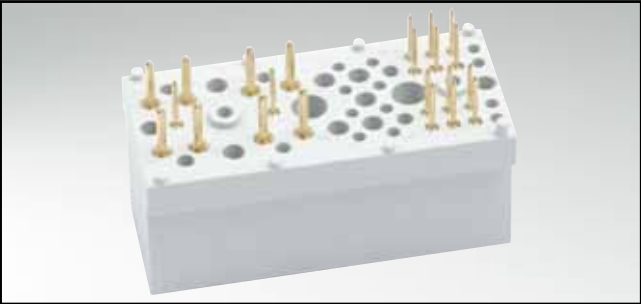

RoHS compliant – UL listed, File no.: E228329

DESCRIPTION

- Signal and power contacts
- Alternatively 22, 30 or 34 positions
- Mating area: gold plated quality class 1 or alternative quality class 3
- Special contact loadings possible on request

PRODUCT DRAWING

PCB-hole pattern (34 positions)

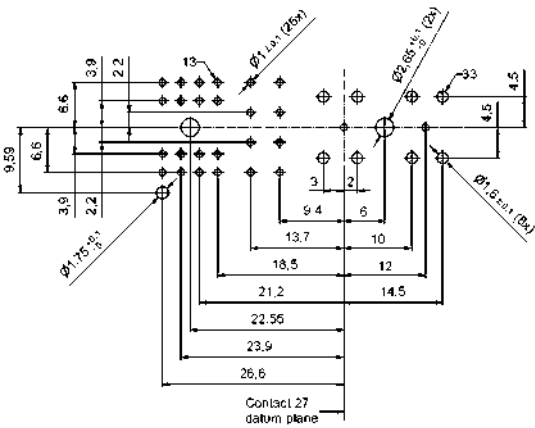
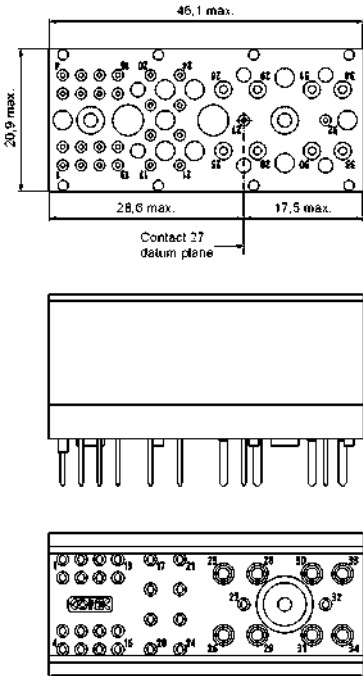

ORDER DATA

(Dim. = mm)

Number of positions	Contacts	Part number Quality class 3 (gold flash)	Part number Quality class 1 (0,8µm Au mating area)
22	14x signal / 8x power	ATC22 W08 FGRAS5 X	ATC22 W08 FGRCSS5 X
30	22x signal / 8x power	ATC30 W08 FGRAS5 X	ATC30 W08 FGRCSS5 X
34	26x signal / 8x power	ATC34 W08 FGRAS5 X	ATC34 W08 FGRCSS5 X

Advanced TCA[®]

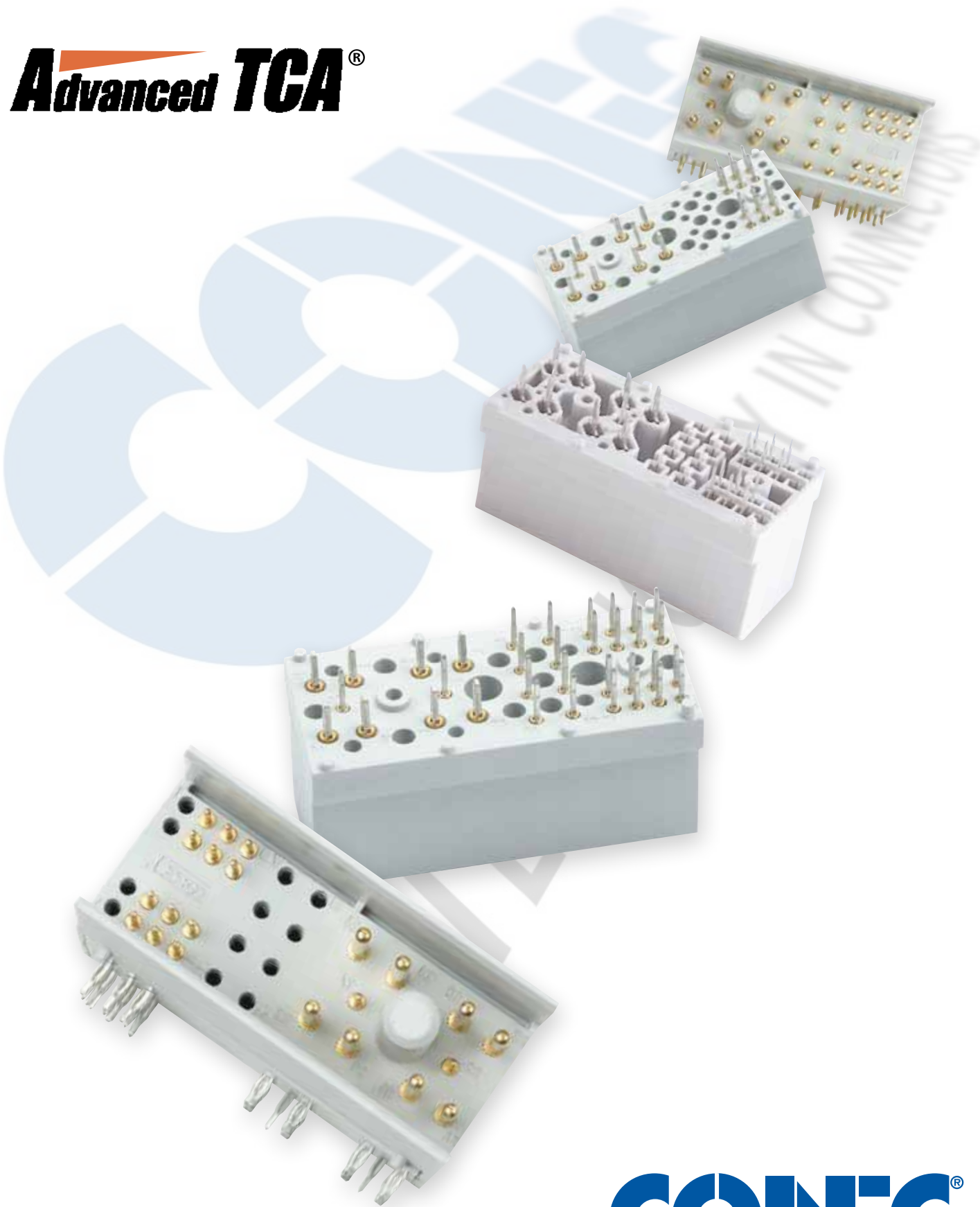

www.conec.com

CONEC[®]
TECHNOLOGY IN CONNECTORS[™]

SECTION 2

MICROTCA CONNECTORS

The MicroTCA system was developed beside the AdvancedTCA system to meet compact and cost effective requirements. This standard was also developed by the PICMG® group. Conec offers now the full range of interface connectors defined in the MicroTCA specification.

MicroTCA systems are modular constructed. The standard system configuration can consist of up to two Power Modules (PM's), two MicroTCA carrier hubs (MCH's) and up to 12 Advanced Mezzanine Cards (AMC's).

The MTCA.0 specification defines Combination D-SUB connectors type 7W2 and 9W4 as interfaces for the external power input to the power modules with direct voltage. These are populated with two power contacts, each with a current carrying capacity of 24 A per power pin for the 7W2 version (for use in power modules with -48/-60 V) and 49 A for the 9W4 version (module with +24 V) and two signal contacts.

Conec offers also special hoods in straight and angled version. These hoods are especially slim designed to fit into the MicroTCA connector footprint requirements.





The energy will be supplied via power module output connectors from the PM into the MicroTCA backplane. This connector is a hybrid connector with 12 power contact pairs and 72 signal contacts in a 2.00 mm pitch. The angled version is applied to the PCB of the power module while the straight version is designed to be mounted on the system backplane. Alignment pins on the insulating body support the guide system of the module and allows a secured mating.

The current carrying capability is min. 9.3 A and a power module is able to supply the energy to twelve AMC Modules.

The interconnection from the MCH and the AMC modules to the backplane is made by the 170-pin high speed signal connector. This connector is a direct mating connector and allows data rates up to 12.5 Gbps. An additional internal conductive barrier supplies an additional shielding between the two signal layers. The connector is designed with „eye of the needle“ press fit contacts and will be installed into the systems backplane securely and without soldering.



TECHNICAL DATA

(AdvancedMC Connector)

Materials		
Housing	Liquid Crystal Polymer (LCP), UL 94-V0	
Contacts	Copper alloy	
Contact plating	Mating area gold over nickel	Termination area tin over nickel
Electrical characteristics		
Insulation resistance (IEC 60512)	General purpose contacts	0.4 A min.
	Ground contacts	0.3 A min.
	Power contacts	1.52 A min.
	Differential pair contacts	0.1 A min.
Contact resistance	25 m Ω	
Insulation resistance	100 M Ω	
Differential Impedance	100 Ω \pm 10%	
Crosstalk	3 % (Multi aggressor condition)	
Differential skew	< 5 ps	
Mechanical Characteristics		
Mating cycles	200	
Mating force	100 N max.	
Withdrawal force	65 N max.	

Technical alterations are subjects to change without notice.

ADVANCEDMC CONNECTOR

Press fit technology – MicroTCA – for high speed signals

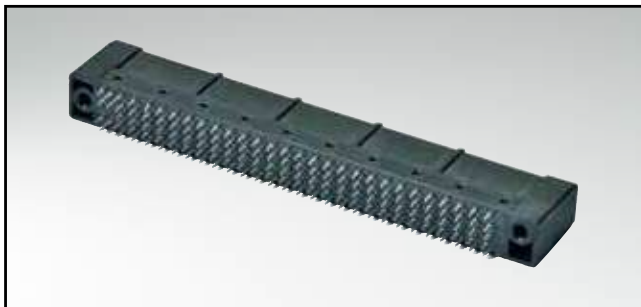

RoHS compliant

DESCRIPTION

- 170 "high speed" signal contacts
- Direct connector for AMC module
- Data transfer rates up to 12.5 Gbps
- Internal shielding
- Eye of the needle press fit
- Mating area gold plated, quality class 1

PRODUCT DRAWING

PCB-hole pattern

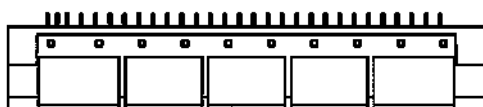
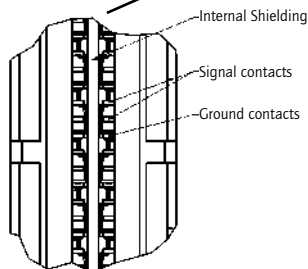
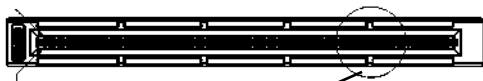
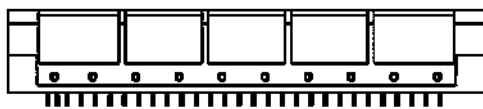

6,95 measured to bottom of card slot

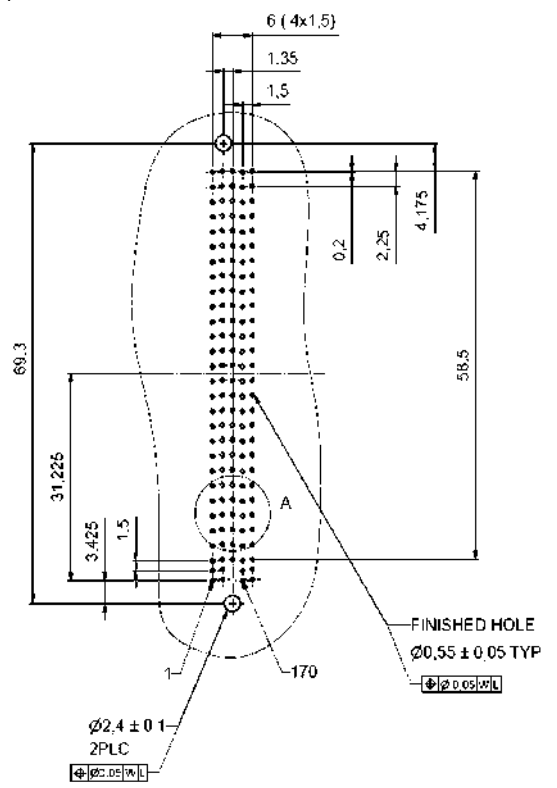
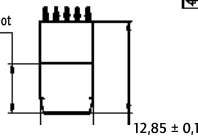

ORDER DATA

(Dim. = mm)

Number of positions	Part number
170	47-000001

TECHNICAL DATA

(Backplane and Power Modul Output Connector)

Materials		
Housing	Thermoplastic polyester, glass filled; UL94-V0	Color: grey
Power contacts	Copper alloy	Mating area gold over nickel Termination area tin plated
Signal contacts	Copper alloy	Termination gold over nickel Termination area tin plated
Electrical characteristics		
Insulation resistance (IEC 60512)	Power contacts and GND contacts	9.3 A per pin at max. 30°C temperature rise
	Signal- and Signal GND contacts	0.5 A at max. 30°C temperature rise
Contact material	Power contacts and GND contacts	11.625 A
	Signal- and Signal GND contacts	0.625 A
Contact resistance	Power contacts and GND contacts	5 mΩ
	Signal- and Signal GND contacts	25 mΩ
Insulation resistance	Power contacts	100 MΩ min.
	Signal contacts	100 MΩ min.
Temperature range	-55°C to +105°C	
Mechanical characteristics		
Mating cycles	200	
Mating force	145 N max.	
Withdrawal force	110 N max.	

Technical alterations are subjects to change without notice.

BACKPLANE CONNECTOR

Press fit technology – straight version

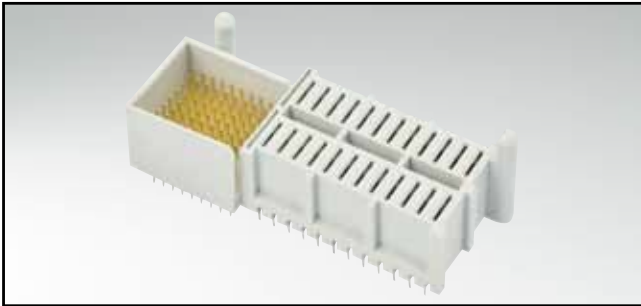

RoHS compliant

DESCRIPTION

- Connector according to MicroTCA specification
- Combination of signal- and power contacts
- Eye of the needle press fit
- Mating area gold plated, quality class 1

PRODUCT DRAWING

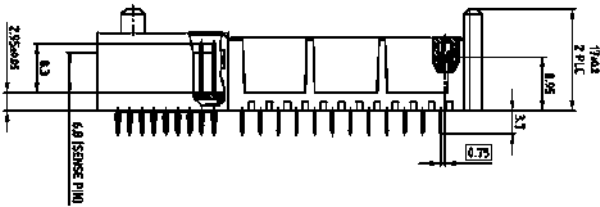

PCB-hole pattern

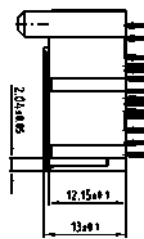
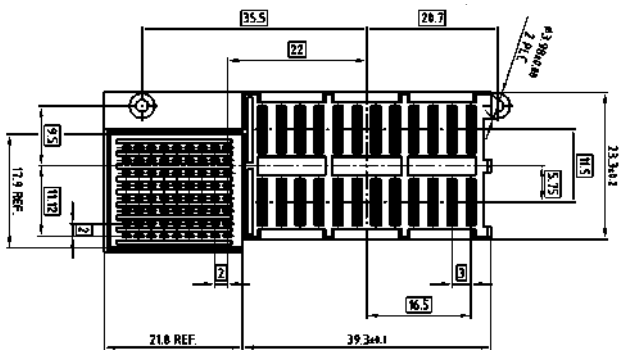
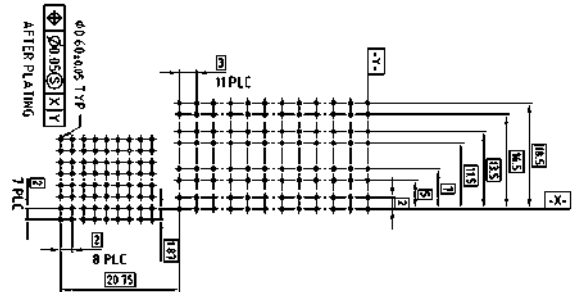

ORDER DATA

(Dim. = mm)

Number of positions	Contacts	Part number
96	72x signal / 24x power	47-100001

POWER MODULE OUTPUT CONNECTOR

Press fit technology – angled version

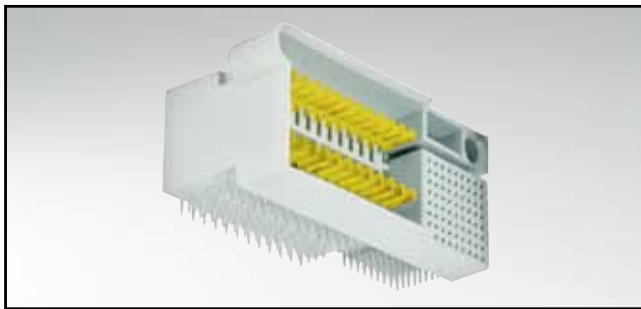

RoHS compliant

DESCRIPTION

- Connector according to MicroTCA specification
- Combination of signal- and power contacts
- Eye of the needle press fit
- Mating area gold plated, quality class 1

PRODUCT DRAWING

PCB-hole pattern

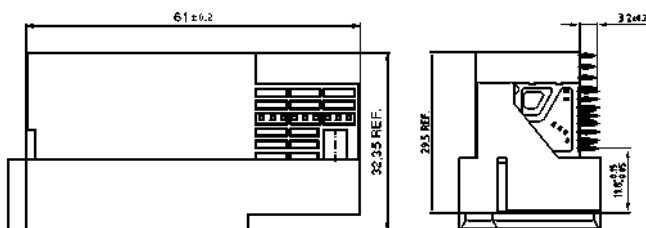
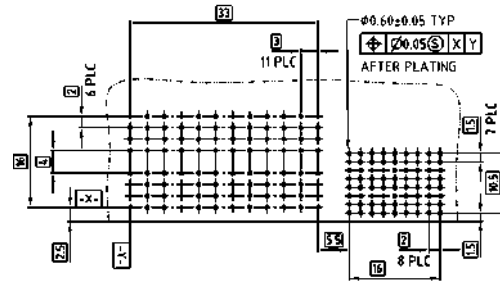
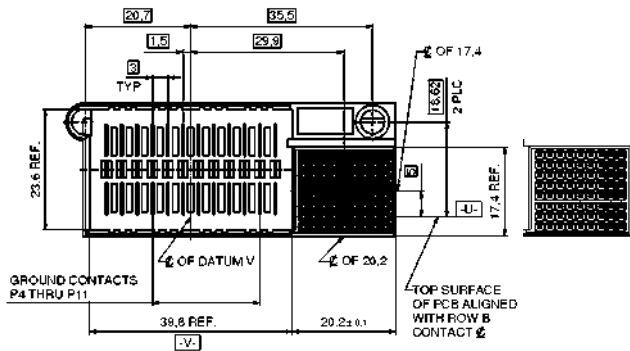

ORDER DATA

(Dim. = mm)

Number of positions	Contacts	Part number
96	72x signal / 24x power	47-100011

TECHNICAL DATA

Power Module Input Connector

Materials		
Insulator	PBT (UL 94-V0)	
Power Contacts	Copper alloy, Precision machined contacts	Mating side gold over nickel Soldering side tin over nickel
Signal contacts	Copper alloy, Precision machined contacts	Mating side gold over nickel Soldering side gold over nickel
Shell	Steel	Tin plated
Mounting bracket	Zink die-cast	Tin plated
4-40 UNC threaded insert	Copper alloy	Tin plated
Hex bolt with 4-40 UNC threaded insert and washers	Steel	Nickel plated
PCB clip for 1.6 mm PCB LP	Copper alloy	Tin plated
Electrical characteristics		
Current rating	Power contacts	24 A at max. 30°C temperature rise
	Signal contacts	7.5 A nominal
Clearance- and creepage distance	Power contacts	1.5 mm min.
	Signal contacts	0.4 mm min.
	Signal and power contacts	1.5 mm min.
	Power contacts and shell	1.5 mm min.
	Signal contacts and shell	1.5 mm min.
Insulation resistance	Power contact	5000 MΩ min.
	Signal contact	5000 MΩ min.
	Signal and power contacts	5000 MΩ min.
	Power contacts and shell	5000 MΩ min.
	Signal contacts and shell	5000 MΩ min.
Dielectric with standing voltage	1000 V r.m.s.	
Mechanical characteristics		
Mating cycles	250	
Mating force	100 N max.	
Unmating force	65 N max.	

Technical alterations are subjects to change without notice.

POWER MODUL INPUT CONNECTORS

Plug connector – solder pin – angled – precision machined contacts – dual port style – through hole solder type

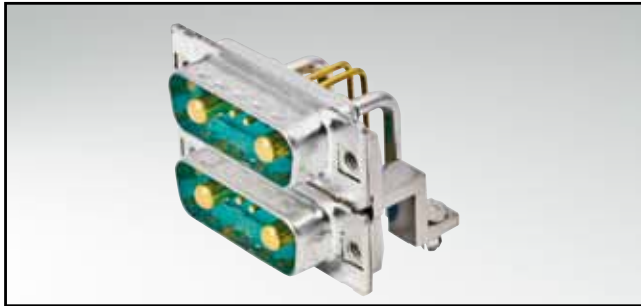

RoHS compliant

DESCRIPTION

- Standard version according to MTCA specification
- Design 7W2 for -48/-60 V Power modul
- 2 power contacts 24 A / 2 signal contacts per port
- Mounting styles:
 - Mounting bracket with PCB clip, 4-40 UNC threaded insert
 - Mounting bracket with PCB clip, 4-40 UNC hex bolt
- Note for 9W4 product please contact factory

PRODUCT DRAWING

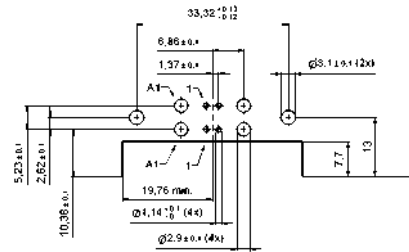
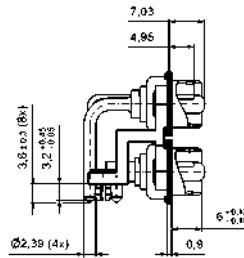
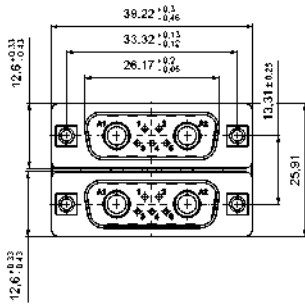

Mounting style:
Mounting bracket with PCB clip,
4-40 UNC threaded insert

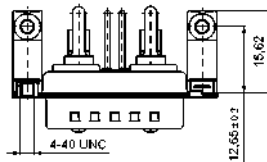

Mounting style:
Mounting bracket with PCB clip,
threaded insert and 4-40 UNC hex bolt

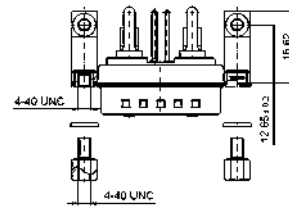

ORDER DATA

(Dim. = mm)

Version	PLUG CONNECTOR Mounting style	Part number
7W2	Mounting bracket with PCB clip/ Threaded insert and 4-40 UNC Hex bolt	13-000011
7W2	Mounting bracket with PCB clip/ 4-40 UNC Threaded insert	13-000021

PCB clip 3.1 mm ± 0.10 mm hole diameter and 1.6 mm circuit board thickness

POWER MODUL INPUT CONNECTORS

Plug connector – solder pin – angled – precision machined contacts – through hole solder type

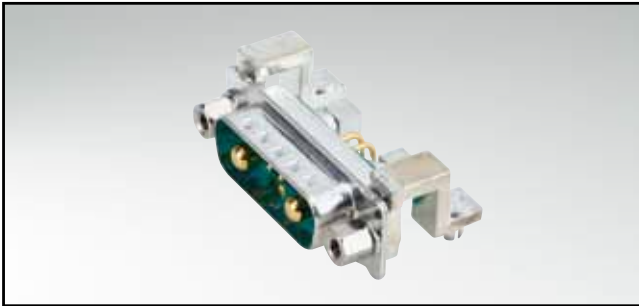

RoHS compliant

DESCRIPTION

- Design 7W2 for -48/-60 V power modul
- 2 power contacts 24 A / 2 signal contacts
- Single port version for MicroTCA PCB layout
- Mounting styles:
 - Mounting bracket with PCB clip, 4-40 UNC threaded insert
 - Mounting bracket with PCB clip, 4-40 UNC hex bolt
- Note for 9W4 product please contact factory

PRODUCT DRAWING

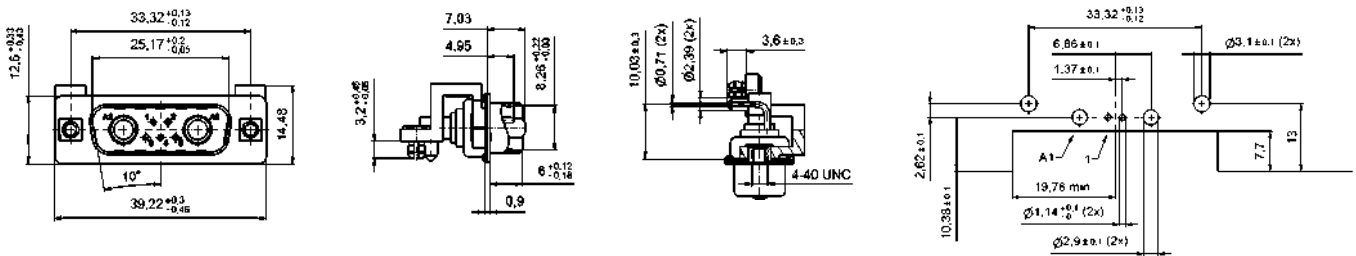

Mounting style:
Mounting bracket with PCB clip,
4-40 UNC threaded insert

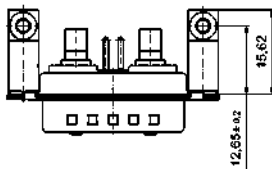

Mounting style:
Mounting bracket with PCB clip,
threaded insert and 4-40 UNC hex bolt

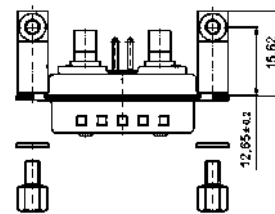

ORDER DATA

(Dim. = mm)

Version	PLUG CONNECTOR Mounting style	Part number
7W2	Mounting bracket with PCB clip/Threaded insert and 4-40 UNC Hex bolt	13-000051
7W2	Mounting bracket with PCB clip/4-40 UNC Threaded insert	13-000061

PCB clip 3.1 mm ± 0.10 mm hole diameter and 1.6 mm circuit board thickness

POWER INPUT CONNECTOR

Socket connector – solder cup or crimp body

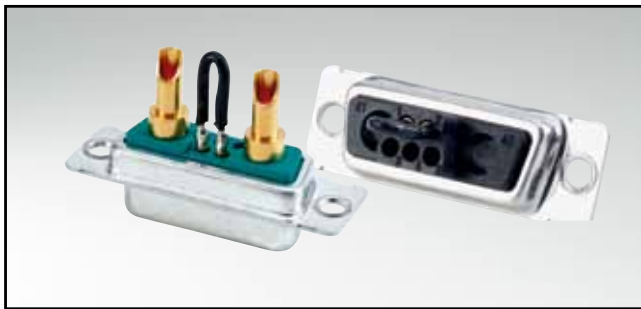

RoHS compliant

DESCRIPTION

- 7W2 MicroTCA Design: 2 power / 2 signal contacts
- Available with bridged and unbridged signal contacts
- Mounting style: with through-hole 3.0 mm
- Power contacts solder cup or crimp type wire size
- Note for 9W4 product please contact factory

PRODUCT DRAWING

Solder cup

AWG	X	Current Rating
10-12	3.5	max. 30 A
12-14	2.7	max. 20 A
16-20	1.8	max. 10 A

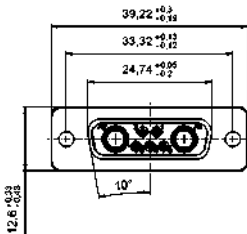

Crimp version

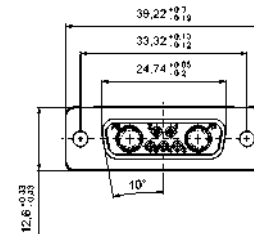

with signal contacts

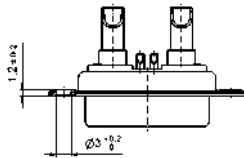

without signal contacts

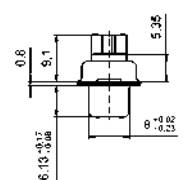
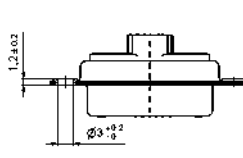

with bridged signal contacts

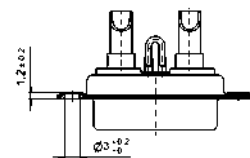

with bridged signal contacts

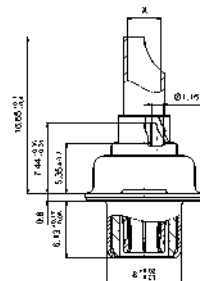
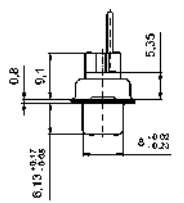
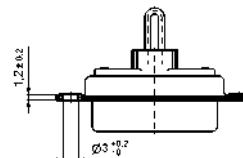

ORDER DATA

(Dim. = mm)

SOCKET CONNECTOR VERSION SOLDER CUP					
Version	Wire size	Current rating	Mounting style	Signal contacts	Part number
7W2	AWG 10 to 12	30 A	Through-hole 3.0 mm	unbridged	13-000131
7W2	AWG 12 to 14	20 A	Through-hole 3.0 mm	unbridged	13-000141
7W2	AWG 16 to 20	10 A	Through-hole 3.0 mm	unbridged	13-000151
7W2	AWG 10 to 12	30 A	Through-hole 3.0 mm	bridged	13-000161
7W2	AWG 12 to 14	20 A	Through-hole 3.0 mm	bridged	13-000171
7W2	AWG 16 to 20	10 A	Through-hole 3.0 mm	bridged	13-000181

SOCKET CONNECTOR CRIMP BODY				
Version	Design	Mounting style	Crimp signal contacts	Part number
7W2	Crimp body	Through-hole 3.0 mm	without	13-000190
7W2	Crimp body	Through-hole 3.0 mm	bridged	13-000201

POWER INPUT CONTACTS

Socket contact – crimp body – precision machined

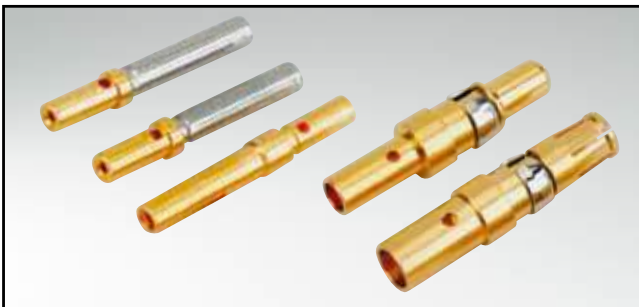

RoHS compliant

DESCRIPTION

- Precision machined contacts
- Quality class 1, standard
- Other quality classes on request

PRODUCT DRAWING

Signal Crimp contact (standard version)

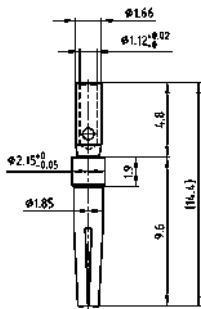

Signal Crimp contact (closed entry version)

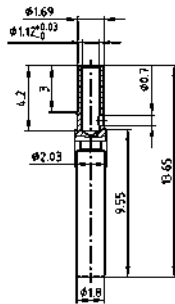

Power Crimp contact (standard version)

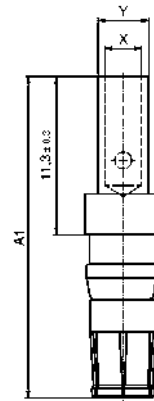

Power Crimp contact (short version)

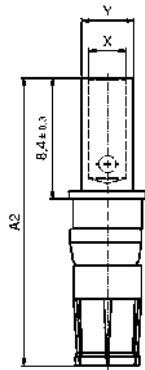

AWG	A ₁	A ₂	X	Y	Current rating
8 to 10		20.08	4.6	5.35	40 A
10 to 12	22.98	20.08	3.7	4.7	30 A
12 to 14	22.98	20.08	2.6	3.6	20 A
16 to 20	22.98	20.08	1.7	2.6	10 A

ORDER DATA

(Dim. = mm)

SOCKET CONNECTOR			
Contact	Wire cross section	Current rating	Part number
Signal crimp (standard version)	AWG 20 to 24	7,5 A	162 C 18709 X
Power crimp (standard version)	AWG 10 to 12 / A = 22.98	30 A	132 C 11039 X
Power crimp (standard version)	AWG 12 to 14 / A = 22.98	20 A	132 C 11029 X
Power crimp (standard version)	AWG 16 to 20 / A = 22.98	10 A	132 C 11019 X
Signal crimp (closed entry version)	AWG 20 to 24	7,5 A (Preferred type)	132 C 15019 X
Power crimp (for MicroTCA) (short version)	AWG 8 to 10 / A = 20.08	40 A	13-000321
Power crimp (for MicroTCA) (short version)	AWG 10 to 12 / A = 20.08	30 A	13-000311
Power crimp (for MicroTCA) (short version)	AWG 12 to 14 / A = 20.08	20 A	13-000301
Power crimp (for MicroTCA) (short version)	AWG 16 to 20 / A = 20.08	10 A	13-000291

CABLE HOOD AND CONNECTOR SET

Plastic hood with crimp connector body – straight cable entry



RoHS compliant

DESCRIPTION

- Compact 7W2 shell inclusive Crimp Socket connector
- Available with bridged signal contacts
- Short 4-40 UNC screws with Phillips or Allen key
- Material Housing: PBT GF; UL 94 V0, black
- Integrated strain relief
- Power contacts for wire size AWG 8 to AWG 20
- Hood can be used only with a special connector

PRODUCT DRAWING

Hood with short screw
(Socket connector included)

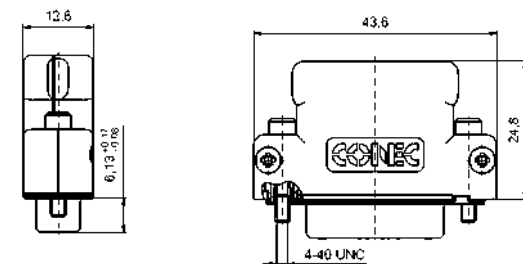
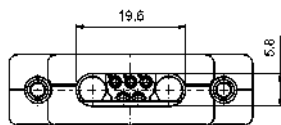
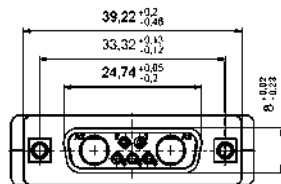

Hood with jack screw
(Socket connector included)

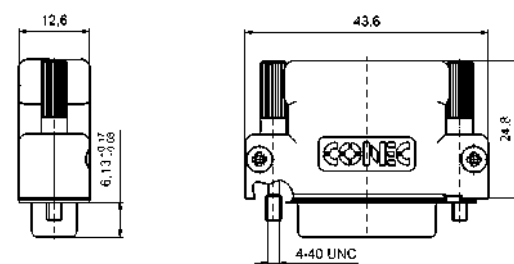
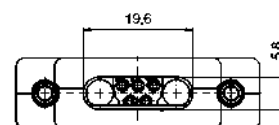
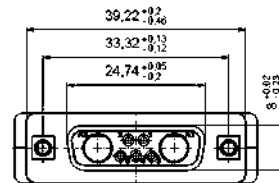

ORDER DATA

(Dim. = mm)

Version	SOCKET CONNECTOR			Part number
	Signal contacts	Screw design		
Hood/Crimp Socket connector 7W2	without	Short/Allen key		13-000210
Hood/Crimp Socket connector 7W2	without	Short/Phillips head		13-000220
Hood/Crimp Socket connector 7W2	bridged	Short/Allen key		13-000231
Hood/Crimp Socket connector 7W2	bridged	Short/Phillips head		13-000241
Hood/Crimp Socket connector 7W2	without	Jack screw/Allen key		13-000370
Hood/Crimp Socket connector 7W2	without	Jack screw/Phillips head		13-000380
Hood/Crimp Socket connector 7W2	bridged	Jack screw/Allen key		13-000391
Hood/Crimp Socket connector 7W2	bridged	Jack screw/Phillips head		13-000401

CABLE HOOD

Metal design – side cable entry



RoHS compliant

DESCRIPTION

- Cable hood for 7W2 MicroTCA Standard Socket connector
- Suitable for other D-SUB Connectors
- Material: Zink die-cast
- Fastening with 4-40 UNC thread and jack screws
- Solide zink die-cast strain relief
- Plastic cable run integrated in shell

PRODUCT DRAWING

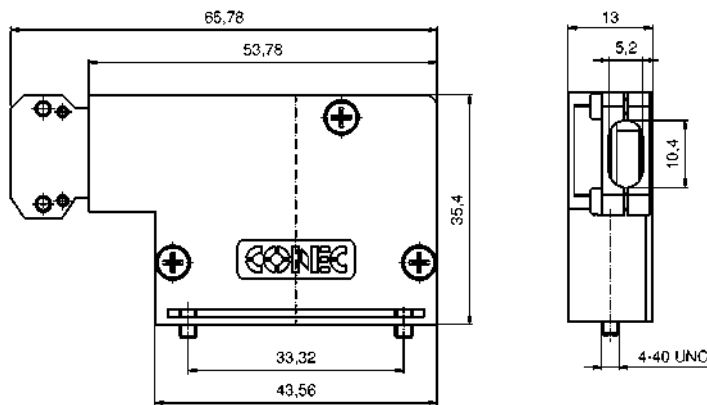

ORDER DATA

(Dim. = mm)

Version	Design	Part number
7W2	Metal hood	16-000010

SECTION 3

COMPACTPCI CONNECTORS



CONEC is a member of the PICMG Group and has developed the 47 positions power connector types, adhering to the specifications outlined in PICMG 2.11 R1.0.

Telecom, datacom, computer, medical, instrumentation and industrial control manufacturers are implementing the Compact PCI Bus structure. 'PCI' as it is known today stands for: Peripheral Component Interconnect.

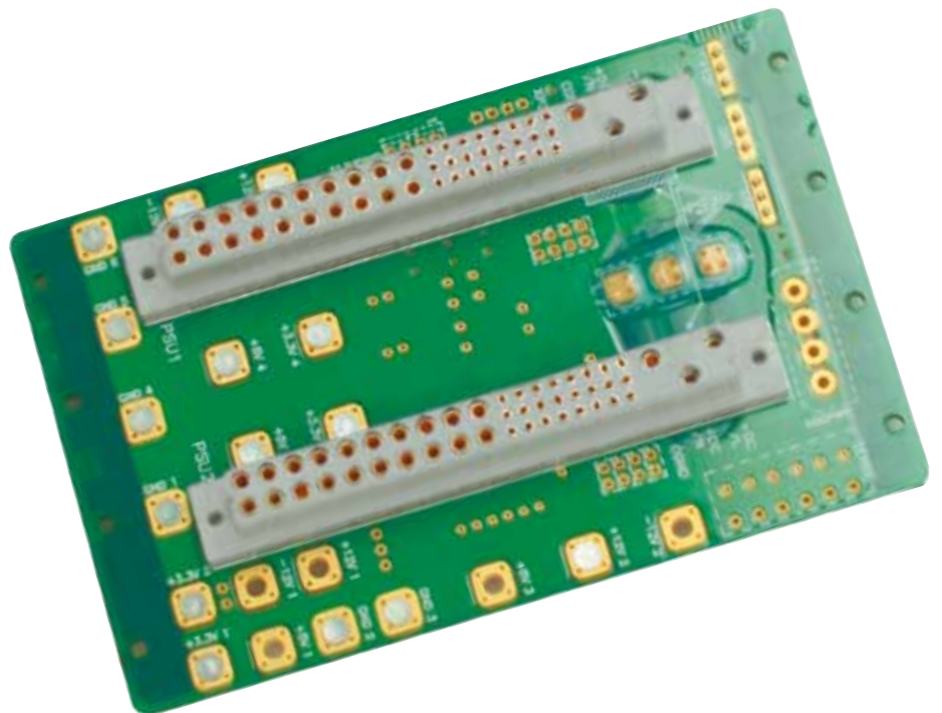

**Product features:**

- Male and female connectors
- Through hole and press fit types
- Precision machined contacts/stamped contacts
- Stamped flexible press fit design
- Selective assembly on request
- Premating and Sequential mating
- Mounting screws for PCB are available

CompactPCI®



TECHNICAL DATA

Materials	
Insulator	Glass filled plastic, UL 94V-0
Contacts	
Materials	Copper alloy
Plating for precision machined contacts	Gold flash over nickel/0,8 µm gold over nickel (press fit design tin over nickel)
Plating for stamped and formed contacts	Gold flash over nickel/selective 0,8 µm gold over nickel
Electrical Characteristics	
Contact Current Ratings, per UL 1977, (see temperature rise curve for details)	
CompactPCI 38 positions	
Size 16 Power Contacts:	
Positions 36, 37 and 38	40 A continuous, all contacts under load
Positions 1 to 20	28 A continuous, all contacts under load
Size 20 Signal Contacts	5 A nominal rating
CompactPCI 47 positions	
Size 16 power contacts:	
Positions 45, 46 and 47	40 A continuous, all contacts under load
Positions 1 to 20	28 A continuous, all contacts under load
Size 22 signal contacts	3 A nominal rating
Initial contact resistance (termination to termination)	
Size 16 power contacts	0.0007 Ω maximum
Size 20 signal contacts	0.004 Ω maximum
Size 22 signal contacts	0.004 Ω maximum
Insulation Resistance	5 G Ω per IEC 512-2 Test 3a method A
Voltage Proof	
CompactPCI 38 positions	
Contacts 36, 37 and 38	3000 V r.m.s.
Contacts 1 to 20	1500 V r.m.s.
Contacts 21 to 35	1000 V r.m.s.
CompactPCI 47 positions	
Size 16 power contacts:	
Contacts 45, 46 and 47	3000 V r.m.s.
Contacts 1 to 20	1500 V r.m.s.
Contacts 21 to 44	1000 V r.m.s.
Creepage and clearance distance (minimum)	
CompactPCI 38 positions	
Contact 38 to 36	3.2 mm
Contact 37 to contact 36	3.2 mm
Contact 38 to signal contacts	6.4 mm
Contact 37 to signal contacts	6.4 mm
Contact 38 to contact 37	2.5 mm
Contact 36 to signal contacts	2.0 mm
CompactPCI 47 positions	
Contact 47 to contact 45	3.2 mm
Contact 46 to contact 45	3.2 mm
Contact 47 to signal contacts	6.4 mm
Contact 46 to signal contacts	6.4 mm
Contact 47 to contact 46	2.5 mm
Contact 45 to signal contacts	2.0 mm

TECHNICAL DATA

Working voltage	
CompactPCI 38 positions	
Contacts 36, 37 and 38	1000 V r.m.s.
Contacts 1 to 20	500 V r.m.s.
Contacts 21 to 35	333 V r.m.s.
CompactPCI 47 positions	
Contacts 45, 46 and 47	1000 V r.m.s.
Contacts 1 to 20	500 V r.m.s.
Contacts 21 to 44	333 V r.m.s.
Mechanical Characteristics	
Blind mating system	Male and female connector bodies provide "lead-in" for 1.3 mm diametral misalignment
Polarization	Provided by connector body design
Crimp contacts	Install contact from termination side; release from mating side
Removable contact retention in connector body	
Size 16 contacts	67 N
Fixed contact retention in connector body	
Size 16 contacts	45 N
Size 20 and 22 contacts	27 N
Resistance to solder heat	260°C for 10 seconds duration per IEC 512-6, Test 12e, 25-watt soldering iron for other application contact factory
Sequential contact mating system	
CompactPCI 38 positions	First mate contact 36 and last mate contact positions 22, 25, and 28
CompactPCI 47 positions	First mate contact 45 and last mate contact position 27
Safety requirements	
CompactPCI 38 positions	Following size 16 contacts are recessed 5 mm below the face of the female insulator for safety requirements
CompactPCI 47 positions	Contact positions 37 and 38 Contact positions 46 and 47
Compliant terminations press fit	Size 16, 20 and 22 contacts are available with compliant press fit compliant contact terminations
Printed board and panel mounting	Mounting holes provided in connector body for both printed board and panel mouting self-tapping screws are available
Mechanical operations	250 cycles
Working temperature	-55°C to +125°C

Technical alterations are subjects to change without notice.

TECHNICAL DATA

Materials	
Insulator	Glass filled plastic, UL 94V-0
Contacts	
Materials	Copper alloy
Plating for precision machined contacts	Gold flash over nickel/0,8 µm gold over nickel (press fit termination tin over nickel)
Plating for stamped and formed contacts	Gold flash over nickel/selective 0,8 µm gold over nickel
Electrical Characteristics	
Contact Current Ratings, per UL 1977	
Mini Power 24 positions	
Size 16 power contacts:	
Positions 22, 23 and 24	45 A continuous, all contacts under load
Positions 1 to 6	35 A continuous, all contacts under load
Size 20 Signal Contacts	3 A nominal rating
Mini Power 26 positions	
Size 16 power contacts:	
Positions 22-26	34 A continuous, all contacts under load
Positions 1 to 6	34 A continuous, all contacts under load
Size 22 signal contacts	3 A nominal rating
Initial contact resistance (termination to termination)	
Size 16 power contacts	0.0007 Ω maximum
Size 20 signal contacts	0.004 Ω maximum
Size 22 signal contacts	0.004 Ω maximum
Insulation Resistance	5 G Ω per IEC 512-2 Test 3a
Voltage Proof	
Mini Power 24 positions	
Contacts 22, 23 and 24	3000 V r.m.s.
Contacts 1 to 6	1500 V r.m.s.
Contacts 2 to 21	1000 V r.m.s.
Mini Power 26 positions	
Size 16 power contacts:	
Contacts 1 to 6	1500 V r.m.s.
Contacts 7 to 21	1000 V r.m.s.
Creepage and clearance distance (minimum)	
Mini Power 24 positions	
Contact 24 to contact 22	3.2 mm
Contact 23 to contact 22	3.2 mm
Contact 24 to contact 23	2.5 mm
Contact 24 to signal contacts	6.4 mm
Contact 23 to signal contacts	6.4 mm
Contact 22 to signal contacts	2.0 mm
Mini Power 26 positions	
Contact 22 to signal contacts	2.0 mm

Technical alterations are subjects to change without notice.

TECHNICAL DATA

Working voltage	
Mini Power 24 positions	
Contacts 22, 23 and 24	1000 V r.m.s.
Contacts 1 to 6	500 V r.m.s.
Contacts 7 to 21	333 V r.m.s.
Mini Power 26 positions	
Contacts 1 to 6 and 22 to 26	500 V r.m.s.
Contacts 7 to 21	333 V r.m.s.

Mechanical Characteristics	
Blind mating system	Male and female connector bodies provide "lead-in" for 1.3 mm diametral misalignment
Polarization	Provided by connector body design
Resistance to solder heat	260°C for 10 seconds duration per IEC 512-6, Test 12e, 25-watt soldering iron for other application contact factory
Sequential contact mating system	
Mini Power 24 positions	First mate contact 22 and last mate contact position 7
Mini Power 26 positions	Last mate contact position 7
Safety requirements	Following size 16 contacts are recessed 5 mm below the face of the female insulator for safety requirements
Mini Power 24 positions	Contact positions 23 and 24
Compliant terminations press fit	Size 16 and 22 contacts are available with compliant contact terminations
Printed board and panel mounting	Mounting holes provided in connector body for both printed board and panel mouting self-tapping screws are available
Mechanical operations	250 cycles
Working temperature	-55°C to +125°C

Technical alterations are subjects to change without notice.

DIAGRAM

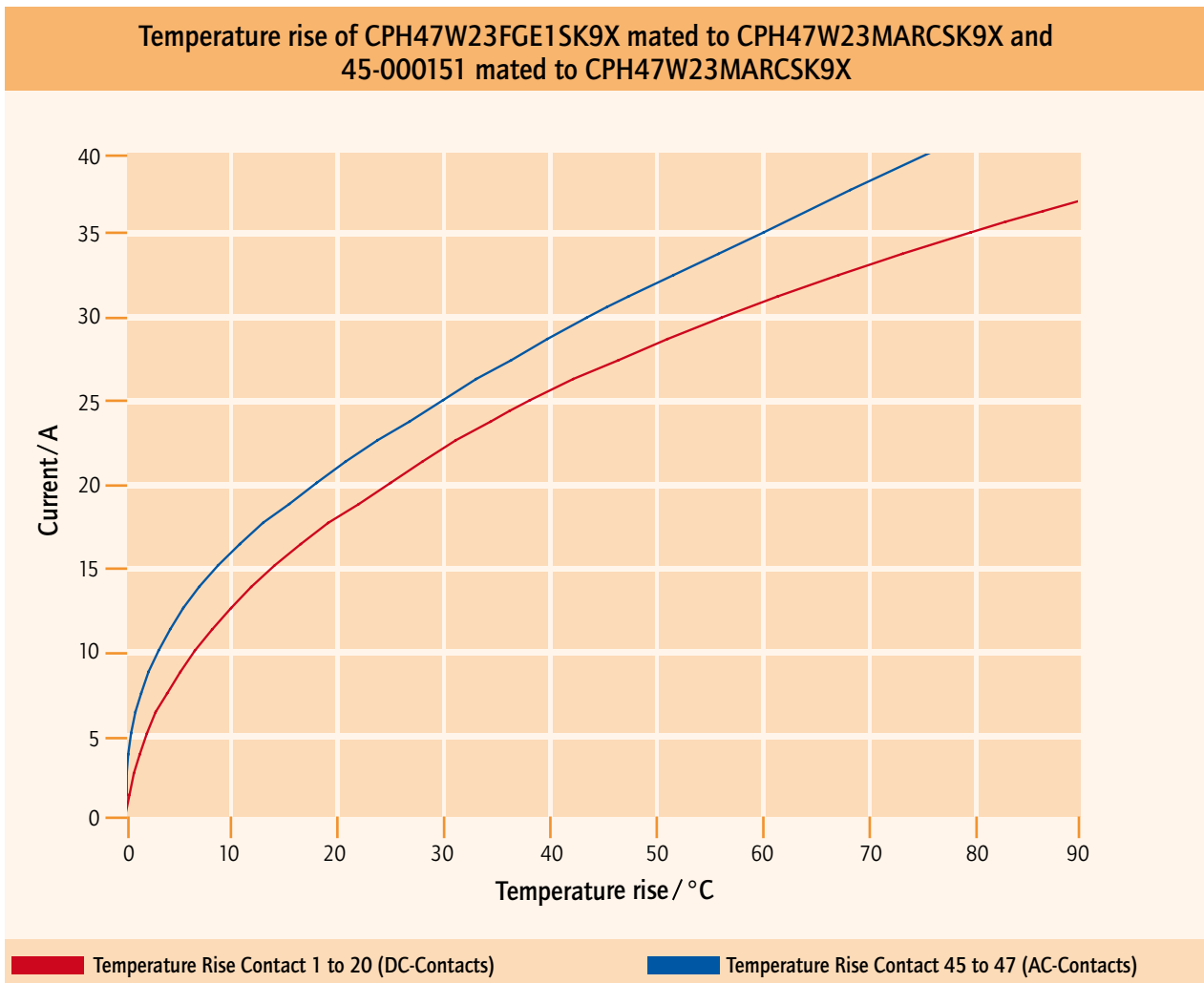

CONVERSION TABLE

μm 1/1000 mm	μinch 1/1000 inch	mm	inch	mm	inch	mm	inch	mm	inch	mm	inch
0,10	4	3,30	.130	10,16	.400	19,50	.768	30,90	1.217	49,50	1.949
0,20	8	3,40	.134	10,26	.402	19,70	.776	31,00	1.220	49,90	1.965
0,25	10	3,50	.138	10,36	.406	19,80	.780	31,20	1.228	50,10	1.972
0,30	12	3,60	.142	10,56	.413	19,90	.783	31,50	1.240	50,30	1.980
0,50	20	3,70	.146	10,66	.417	20,00	.787	31,70	1.248	50,50	1.988
0,70	28	3,80	.150	10,76	.421	20,10	.791	32,00	1.260	50,70	1.996
0,75	30	3,81	.150	11,00	.433	20,30	.799	32,20	1.268	50,80	2.000
0,80	32	3,90	.154	11,20	.441	20,32	.800	32,30	1.272	51,40	2.024
1,00	39	4,00	.158	11,40	.449	20,50	.807	32,50	1.280	51,50	2.028
1,27	50	4,10	.161	11,50	.453	21,00	.827	32,80	1.291	52,00	2.047
2,00	79	4,20	.165	11,60	.457	21,10	.831	33,00	1.299	52,30	2.059
2,50	98	4,30	.169	11,90	.469	21,70	.854	33,10	1.303	52,80	2.079
3,00	118	4,50	.177	12,00	.472	22,00	.866	33,30	1.311	53,00	2.087
4,00	157	4,70	.185	12,20	.480	22,10	.870	33,80	1.331	53,20	2.095
5,00	197	4,90	.193	12,30	.484	22,20	.874	34,00	1.339	53,80	2.118
mm	inch	5,00	.197	12,40	.488	22,30	.878	34,20	1.346	54,00	2.126
0,10	.004	5,08	.200	12,50	.492	22,40	.882	34,40	1.354	54,20	2.134
0,20	.008	5,10	.201	12,70	.500	22,50	.886	35,00	1.378	54,90	2.161
0,25	.012	5,20	.205	12,90	.508	22,60	.890	35,40	1.394	55,00	2.165
0,35	.014	5,30	.209	13,00	.512	22,80	.898	35,50	1.398	55,40	2.181
0,40	.016	5,40	.213	13,10	.516	22,86	.900	35,56	1.400	55,70	2.193
0,45	.018	5,50	.217	13,20	.520	22,90	.902	35,60	1.402	56,60	2.228
0,50	.020	5,60	.220	13,50	.532	23,00	.906	36,00	1.417	57,40	2.260
0,55	.022	5,70	.224	13,60	.535	23,10	.909	36,50	1.437	57,80	2.276
0,60	.024	5,80	.228	13,70	.539	23,30	.917	36,60	1.441	57,90	2.280
0,64	.025	6,00	.236	13,90	.547	23,50	.925	36,70	1.445	58,42	2.300
0,65	.026	6,10	.240	14,00	.551	24,00	.945	37,00	1.457	59,00	2.323
0,70	.028	6,40	.252	14,30	.563	24,30	.957	37,30	1.469	59,20	2.331
0,75	.030	6,50	.256	14,40	.567	24,60	.969	37,50	1.476	59,80	2.354
0,80	.032	6,60	.260	14,50	.571	24,90	.980	37,60	1.480	59,90	2.358
0,85	.034	6,70	.264	14,70	.579	25,00	.984	37,70	1.484	60,00	2.362
0,90	.035	6,80	.268	14,80	.583	25,10	.998	37,90	1.492	60,96	2.400
1,00	.039	6,90	.272	14,90	.587	25,40	1.000	38,00	1.496	61,10	2.406
1,20	.047	7,00	.276	14,98	.590	25,60	1.008	38,10	1.500	62,00	2.441
1,25	.049	7,10	.280	15,00	.591	25,90	1.020	39,00	1.535	63,00	2.480
1,27	.050	7,20	.283	15,20	.598	26,00	1.024	39,20	1.543	63,50	2.500
1,30	.051	7,40	.291	15,24	.600	26,30	1.035	39,30	1.547	64,00	2.520
1,35	.053	7,50	.295	15,40	.606	26,60	1.047	39,90	1.571	65,00	2.560
1,40	.055	7,60	.299	15,50	.610	26,70	1.051	40,00	1.575	67,00	2.638
1,45	.057	7,62	.300	15,60	.614	27,00	1.063	40,30	1.587	68,00	2.677
1,50	.059	7,70	.303	15,90	.626	27,20	1.071	40,40	1.591	69,00	2.717
1,60	.063	7,80	.307	16,00	.630	27,40	1.079	40,60	1.598	70,00	2.756
1,70	.067	7,98	.314	16,20	.638	27,50	1.093	41,00	1.614	71,00	2.795
1,80	.071	8,00	.315	16,50	.650	27,90	1.098	41,60	1.638	74,00	2.913
1,85	.073	8,18	.318	16,60	.654	27,94	1.100	42,70	1.681	75,00	2.953
1,90	.075	8,20	.323	16,80	.661	28,00	1.102	43,18	1.700	76,20	3.000
2,00	.079	8,30	.327	17,00	.669	28,20	1.110	44,20	1.740	77,00	3.032
2,10	.083	8,40	.331	17,20	.677	28,50	1.122	44,80	1.764	78,74	3.100
2,20	.087	8,50	.335	17,30	.681	28,70	1.130	45,80	1.803	80,00	3.150
2,30	.091	8,60	.339	17,50	.689	29,00	1.142	46,30	1.823	81,28	3.200
2,40	.095	8,90	.350	17,60	.693	29,20	1.150	46,70	1.839	84,00	3.307
2,50	.098	9,00	.354	17,70	.697	29,40	1.158	47,00	1.850	85,00	3.346
2,54	.100	9,10	.358	17,78	.700	29,50	1.161	47,20	1.858	86,36	3.400
2,60	.102	9,20	.362	17,80	.701	29,70	1.169	47,30	1.862	88,90	3.500
2,70	.106	9,30	.366	17,90	.705	29,90	1.177	47,50	1.870	90,00	3.543
2,80	.110	9,40	.370	18,00	.709	30,00	1.181	47,80	1.882	91,44	3.600
2,84	.112	9,50	.374	18,10	.713	30,20	1.189	48,00	1.890	94,00	3.701
2,90	.114	9,60	.378	18,30	.721	30,40	1.197	48,10	1.894	95,00	3.740
3,00	.118	9,70	.382	18,60	.732	30,48	1.200	48,26	1.900	100,00	3.937
3,10	.122	9,90	.390	19,00	.748	30,50	1.201	48,80	1.921	110,00	4.331
3,20	.126	10,00	.395	19,20	.756	30,80	1.213	49,10	1.933	120,00	4.724

COMPACTPCI

Male connector – solder pin – angled – precision machined contacts – 38 positions



RoHS compliant – UL listed, File no.: E228329

DESCRIPTION

- Signal and power contacts
- 38 contacts, 15x signal / 23x power
- Sequential mating
- Contact plating quality class 1 or alternative quality class 3
- Special contact loadings possible on request

PRODUCT DRAWING

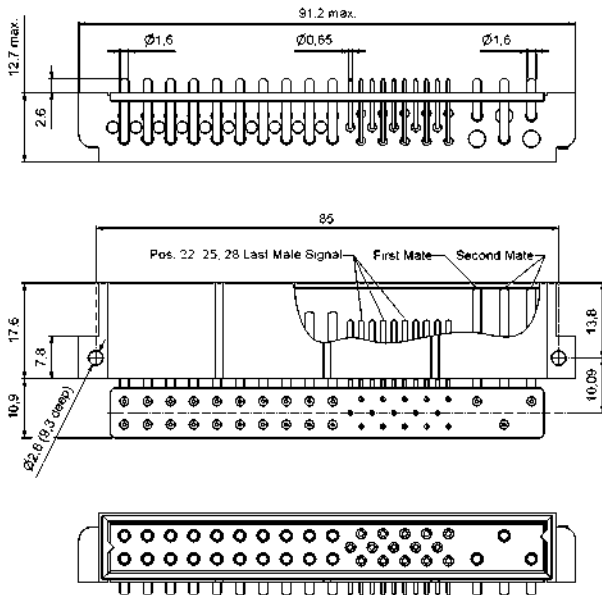

PCB-hole pattern

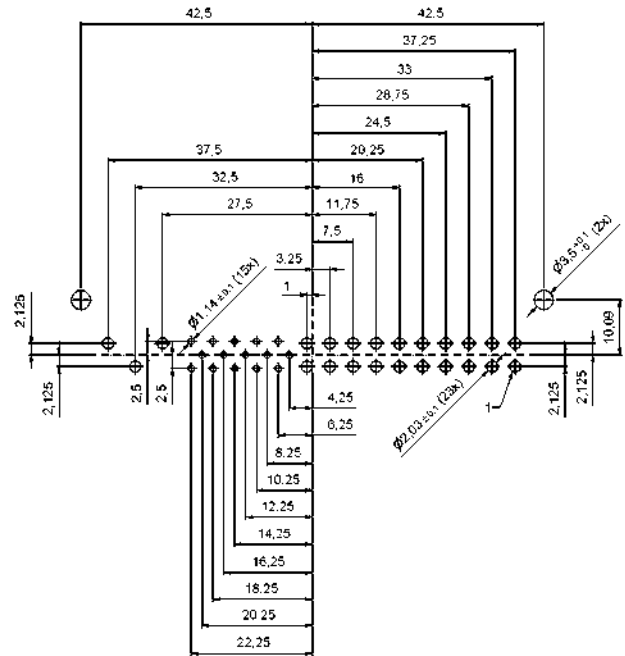

ORDER DATA

(Dim. = mm)

Number of positions	Contacts	Part number Quality class 3 (gold flash)	Part number Quality class 1 (0.8µm Au mating area)
38	15x signal / 23x power	CPH38 W23 MARASK9 X	CPH38 W23 MARCSK9 X

COMPACTPCI

Male connector – solder pin – angled – precision machined contacts – 38 positions



RoHS compliant – UL listed, File no.: E228329

DESCRIPTION

- Signal and power contacts
- 38 contacts, 15x signal / 23x power
- Sequential mating
- Contact plating quality class 1 or alternative quality class 3
- **Inverted version**
- Special contact loadings possible on request

PRODUCT DRAWING

PCB-hole pattern

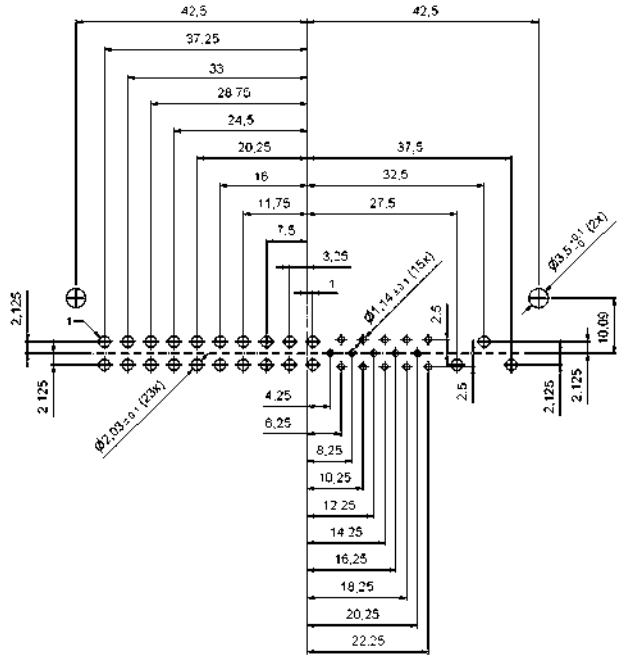
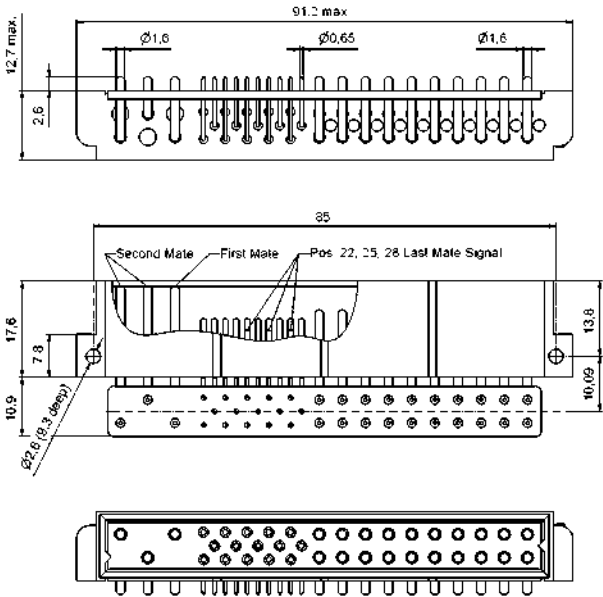

ORDER DATA

(Dim. = mm)

Number of positions	Contacts	Part number Quality class 3 (gold flash)	Part number Quality class 1 (0.8µm Au mating area)
38	15x signal / 23x power	CPH38 W23 MARARK9 X	CPH38 W23 MARCRK9 X

COMPACTPCI

Male connector – solder pin – angled – precision machined contacts – 47 positions

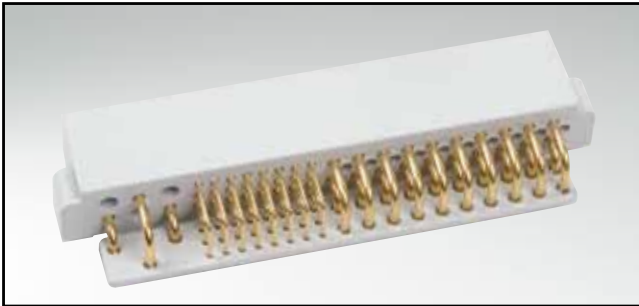

RoHS compliant – UL listed, File no.: E228329

DESCRIPTION

- Signal and power contacts
- 47 contacts, 24x signal / 23x power
- Sequential mating
- Contact plating quality class 1 or alternative quality class 3
- Special contact loadings possible on request

PRODUCT DRAWING

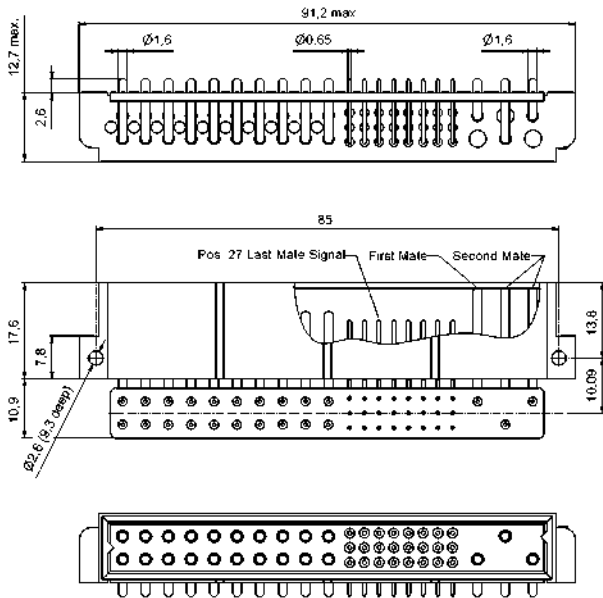

PCB-hole pattern

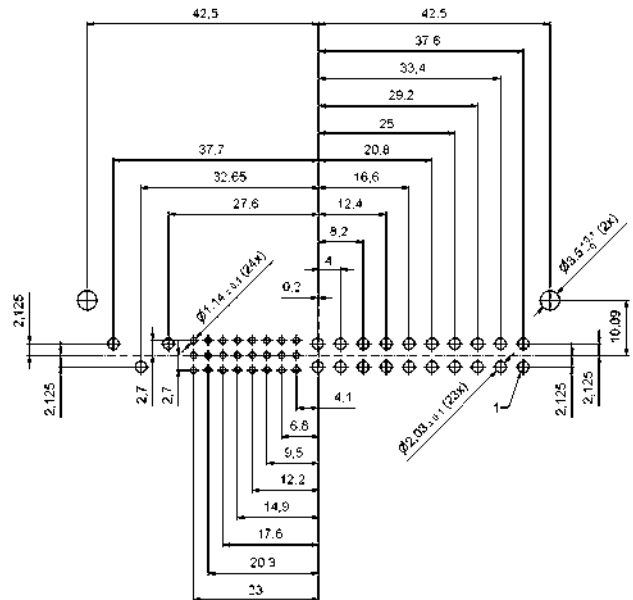

ORDER DATA

(Dim. = mm)

Number of positions	Contacts	Part number Quality class 3 (gold flash)	Part number Quality class 1 (0.8µm Au mating area)
47	24x signal / 23x power	CPH47 W23 MARASK9 X	CPH47 W23 MARCSK9 X

COMPACTPCI

Male connector – solder pin – angled – precision machined contacts – 47 positions

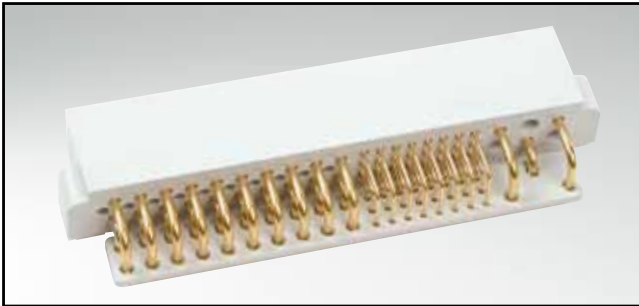

RoHS compliant – UL listed, File no.: E228329

DESCRIPTION

- Signal and power contacts
- 47 contacts, 24x signal / 23x power
- Sequential mating
- Contact plating quality class 1 or alternative quality class 3
- **Inverted version**
- Special contact loadings possible on request

PRODUCT DRAWING

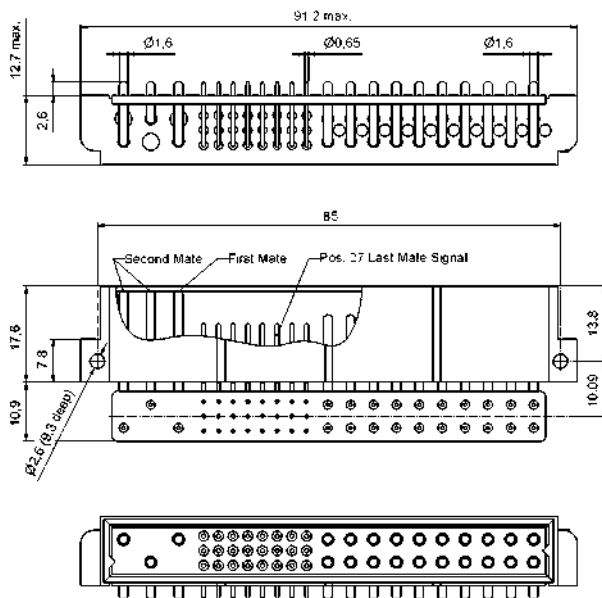

PCB-hole pattern

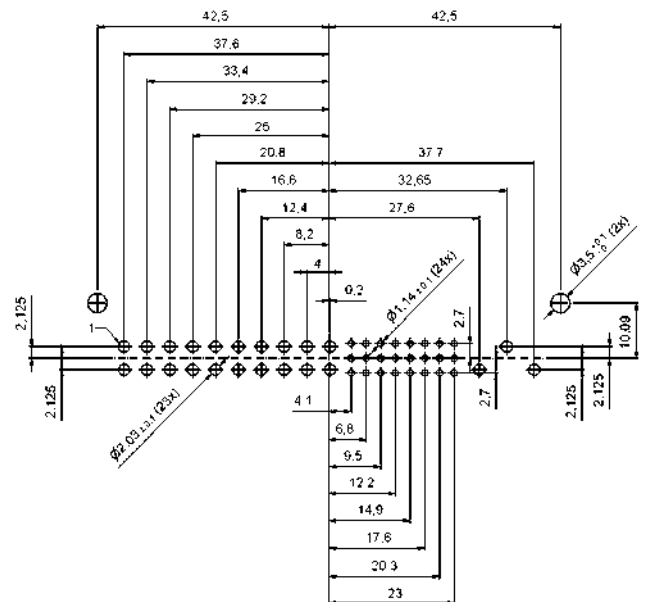

ORDER DATA

(Dim. = mm)

Number of positions	Contacts	Part number Quality class 3 (gold flash)	Part number Quality class 1 (0.8µm Au mating area)
47	24x signal / 23x power	CPH47 W23 MARARK9 X	CPH47 W23 MARCRK9 X

COMPACTPCI

Female connector – angled – precision machined contacts – 38 positions

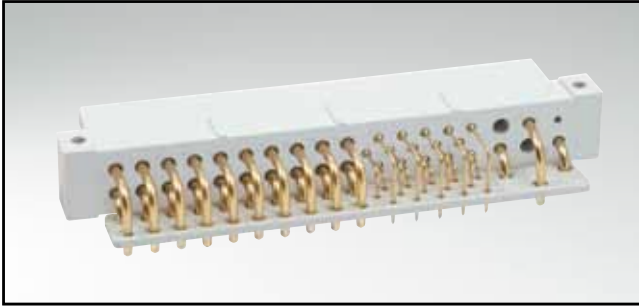

RoHS compliant – UL listed, File no.: E228329

DESCRIPTION

- Signal and power contacts
- 38 contacts, 15x signal / 23x power
- Sequential mating
- Contact plating quality class 1 or alternative quality class 3
- Special contact loadings possible on request

PRODUCT DRAWING

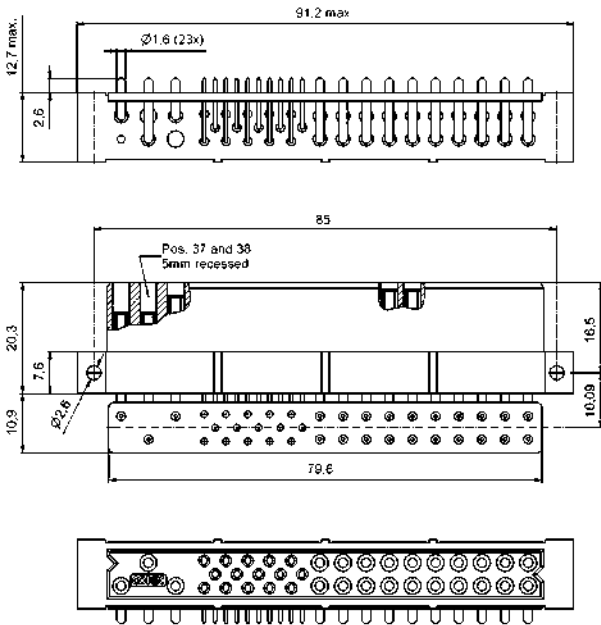

PCB-hole pattern

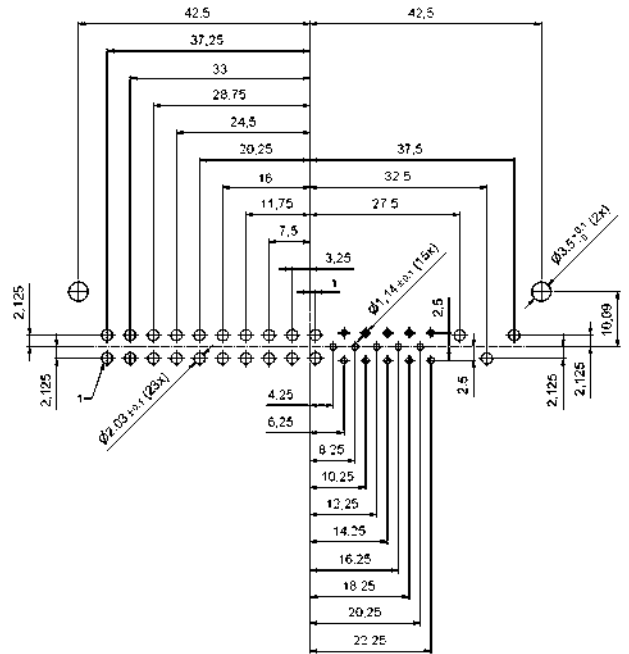

ORDER DATA

(Dim. = mm)

Number of positions	Contacts	Part number Quality class 3 (gold flash)	Part number Quality class 1 (0.8µm Au mating area)
38	15x signal / 23x power	CPH38 W23 FARASK9 X	CPH38 W23 FARCSK9 X

COMPACTPCI

Female connector – solder pin – angled – precision machined contacts – 38 positions

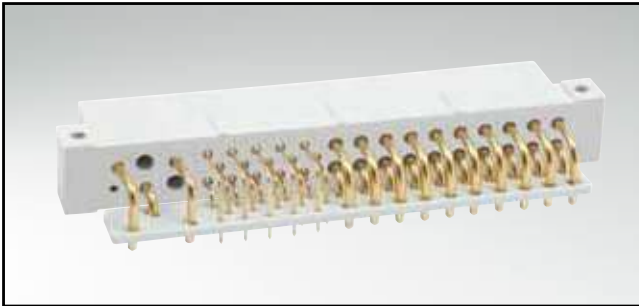

RoHS compliant – UL listed, File no.: E228329

DESCRIPTION

- Signal and power contacts
- 38 contacts, 15x signal / 23x power
- Sequential mating
- Contact plating quality class 1 or alternative quality class 3
- **Inverted version**
- Special contact loadings possible on request

PRODUCT DRAWING

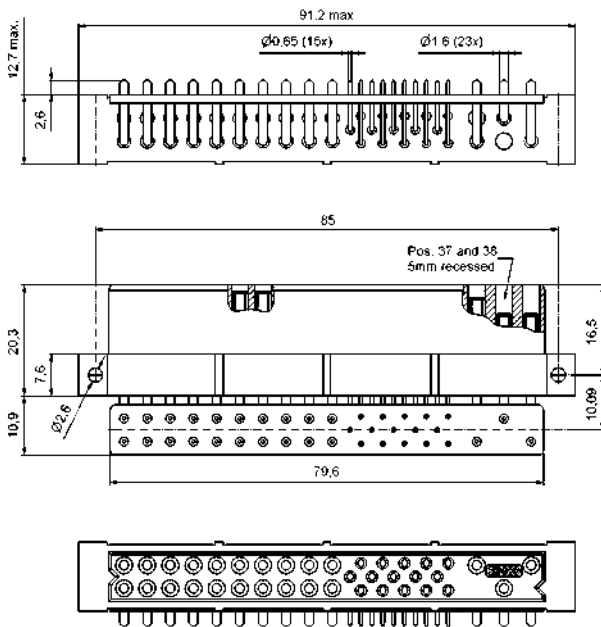

PCB-hole pattern

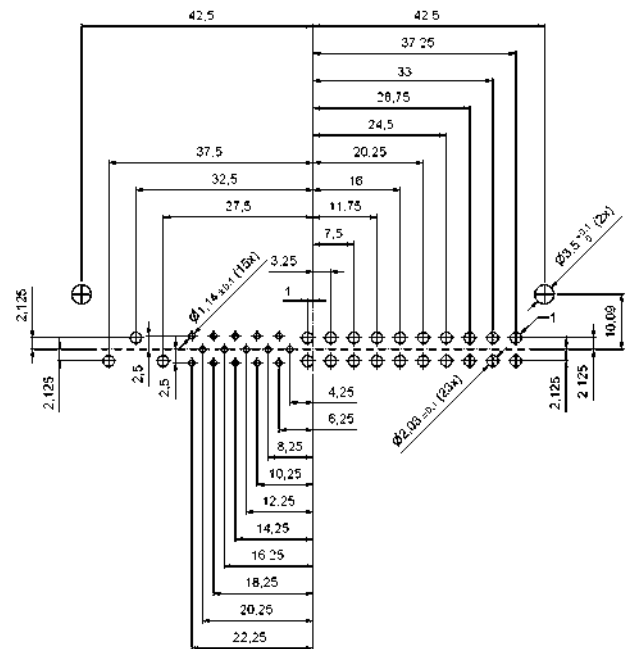

ORDER DATA

(Dim. = mm)

Number of positions	Contacts	Part number Quality class 3 (gold flash)	Part number Quality class 1 (0.8 μ m Au mating area)
38	15x signal / 23x power	CPH38 W23 FARARK9 X	CPH38 W23 FARCRK9 X

COMPACTPCI

Female connector – angled – precision machined contacts – 47 positions

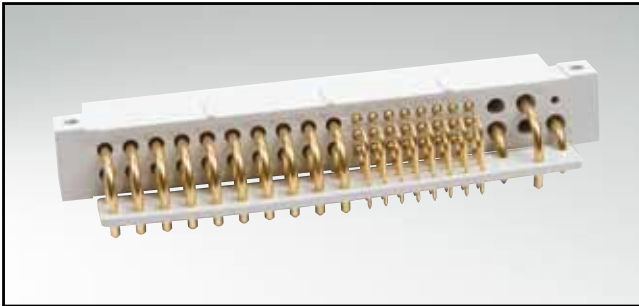

RoHS compliant – UL listed, File no.: E228329

DESCRIPTION

- Signal and power contacts
- 47 contacts, 24x signal / 23x power
- Sequential mating
- Contact plating quality class 1 or alternative quality class 3
- Special contact loadings possible on request

PRODUCT DRAWING

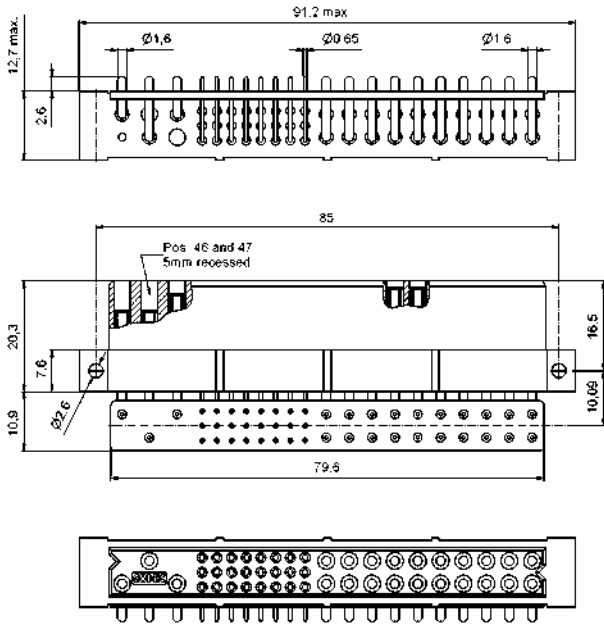

PCB-hole pattern

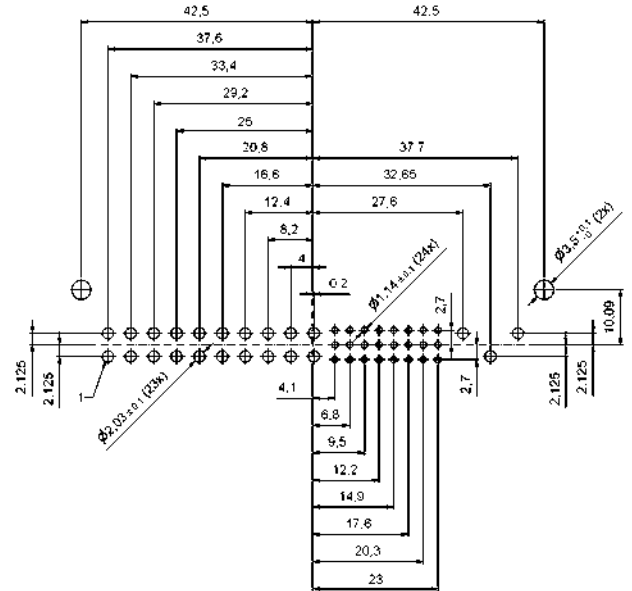

ORDER DATA

(Dim. = mm)

Number of positions	Contacts	Part number Quality class 3 (gold flash)	Part number Quality class 1 (0.8 μ m Au mating area)
47	24x signal / 23x power	CPH47 W23 FARASK9 X	CPH47 W23 FARCSK9 X

COMPACTPCI

Female connector – angled – precision machined contacts – 47 positions

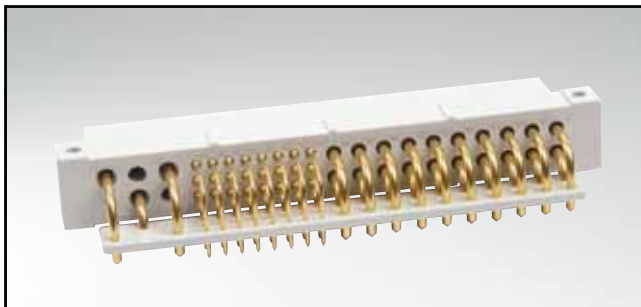

RoHS compliant – UL listed, File no.: E228329

DESCRIPTION

- Signal and power contacts
- 47 contacts, 24x signal / 23x power
- Sequential mating
- Contact plating quality class 1 or alternative quality class 3
- **Inverted version**
- Special contact loadings possible on request

PRODUCT DRAWING

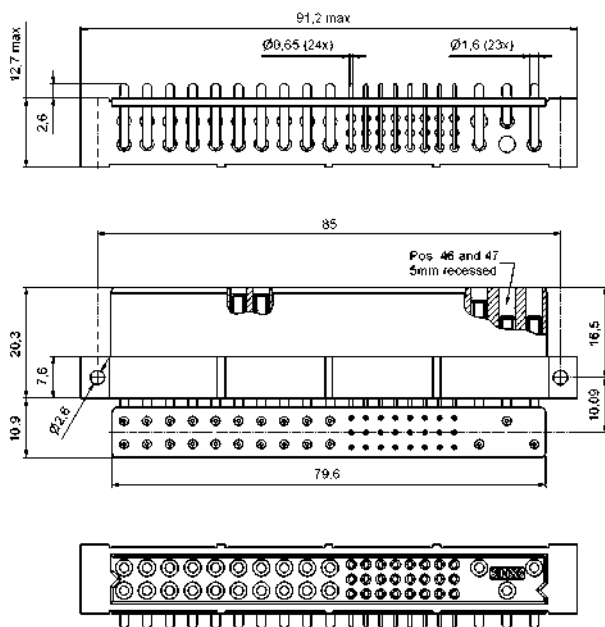

PCB-hole pattern

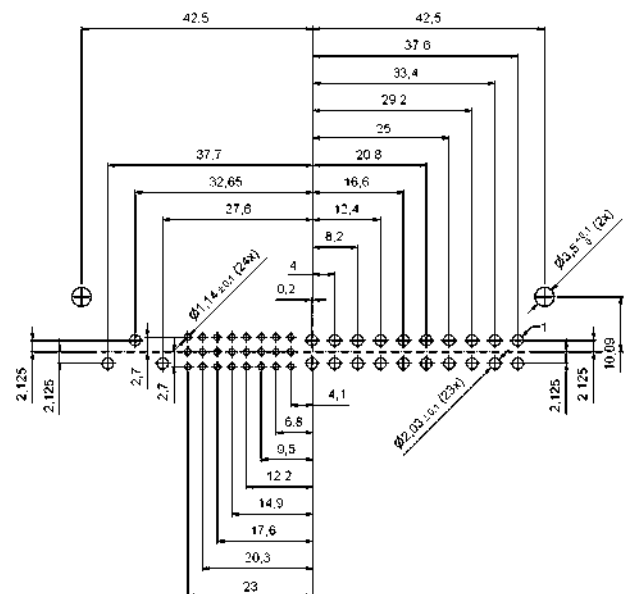

ORDER DATA

(Dim. = mm)

Number of positions	Contacts	Part number Quality class 3 (gold flash)	Part number Quality class 1 (0.8µm Au mating area)
47	24x signal / 23x power	CPH47 W23 FARARK9 X	CPH47 W23 FARCRK9 X

COMPACTPCI

Female connector – angled – precision machined contacts – 47 positions

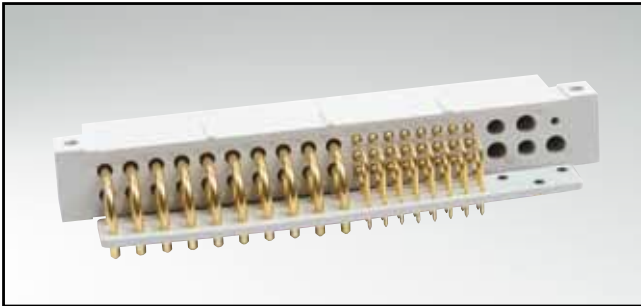

RoHS compliant – UL listed, File no.: E228329

DESCRIPTION

- Signal and power contacts
- Selectively loaded with 24x signal / 20x power
- Position 45 to 47 for crimp contacts (page 3 | 36)
- Contact plating quality class 1 or alternative quality class 3
- Special contact loadings possible on request

PRODUCT DRAWING

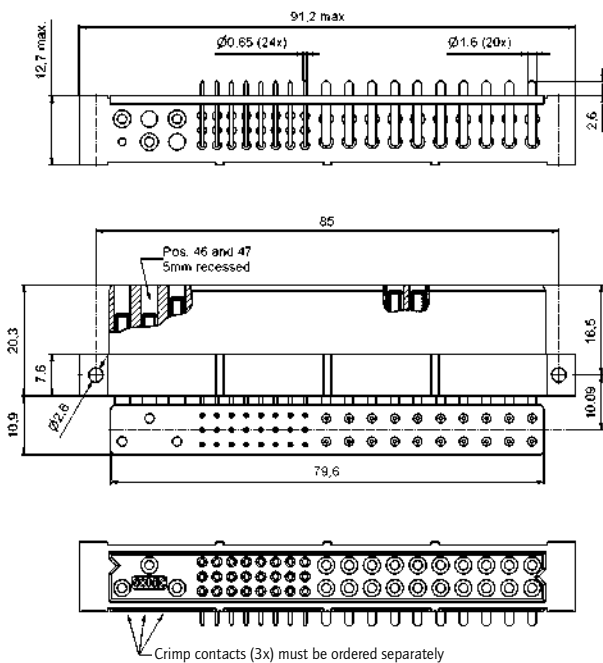

PCB-hole pattern

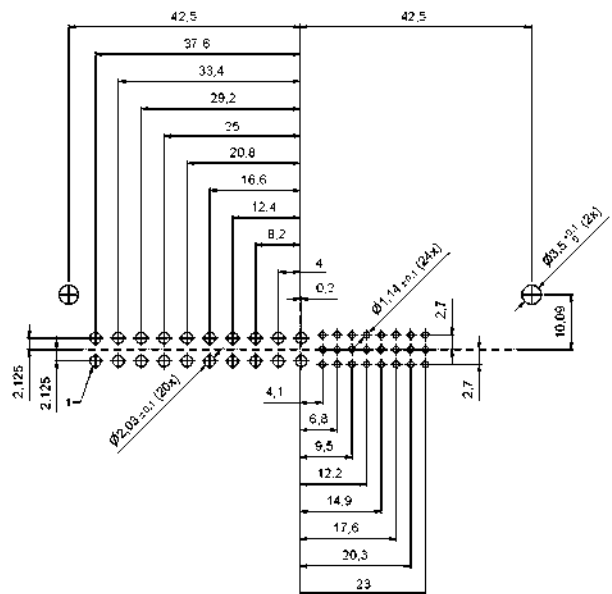

ORDER DATA

(Dim. = mm)

Number of positions	Contacts	Part number Quality class 3 (gold flash)	Part number Quality class 1 (0.8µm Au mating area)
47	24x signal / 20x power	CPH47 W23 FARASN9 X	CPH47 W23 FARCSN9 X

COMPACTPCI

Female connector – angled – precision machined contacts – 47 positions

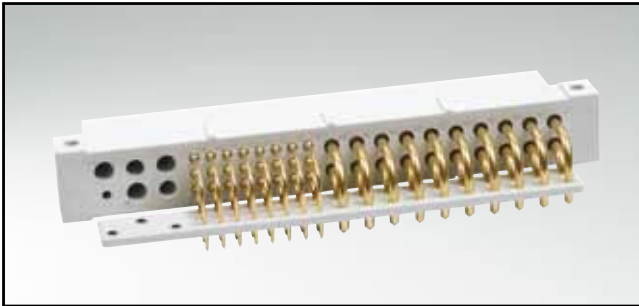

RoHS compliant – UL listed, File no.: E228329

DESCRIPTION

- Signal and power contacts
- Selectively loaded with 24x signal / 20x power
- Position 45 to 47 for crimp contacts (page 3 | 36)
- Contact plating quality class 1 or alternative quality class 3
- **Inverted version**
- Special contact loadings possible on request

PRODUCT DRAWING

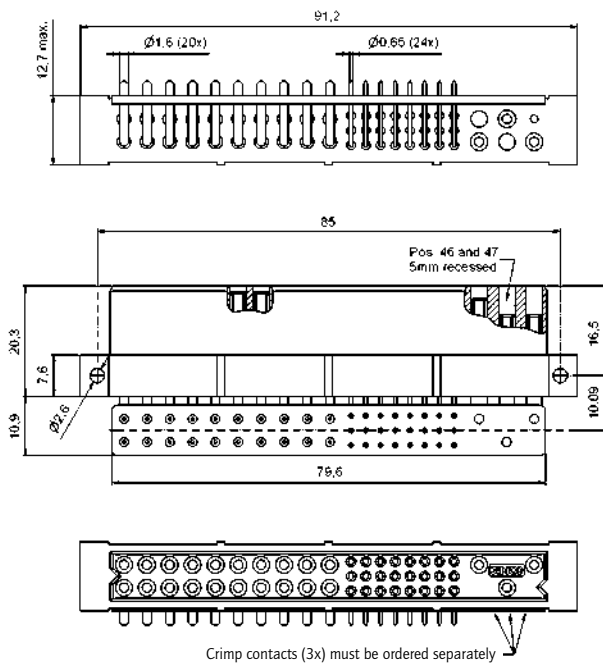

PCB-hole pattern

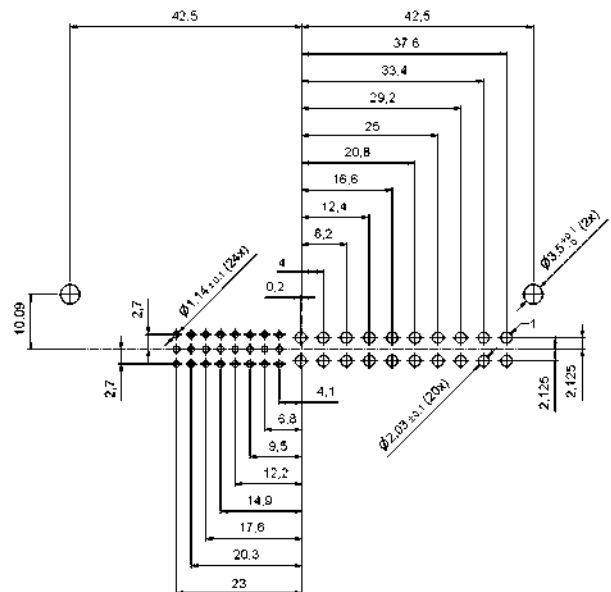

ORDER DATA

(Dim. = mm)

Number of positions	Contacts	Part number Quality class 3 (gold flash)	Part number Quality class 1 (0.8 μ m Au mating area)
47	24x signal / 20x power	CPH47 W23 FARARN9 X	CPH47 W23 FARCRN9 X

COMPACTPCI

Male connector – solder pin – straight – precision machined contacts – 38 positions

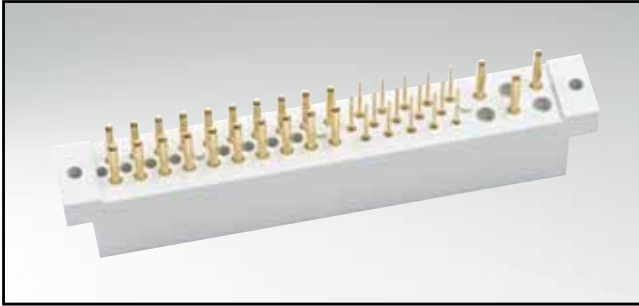

RoHS compliant – UL listed, File no.: E228329

DESCRIPTION

- Signal and power contacts
- 38 contacts, 15x signal / 23x power
- Sequential mating
- Contact plating quality class 1 or alternative quality class 3
- Special contact loadings possible on request

PRODUCT DRAWING

PCB-hole pattern

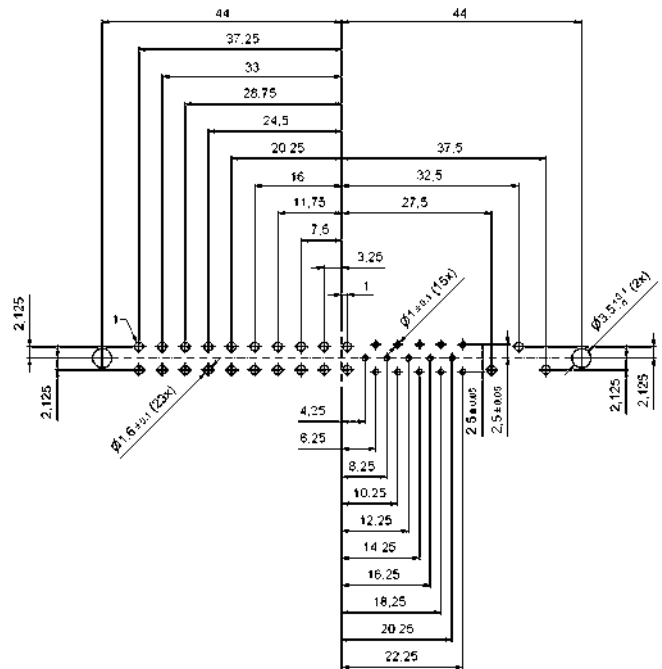
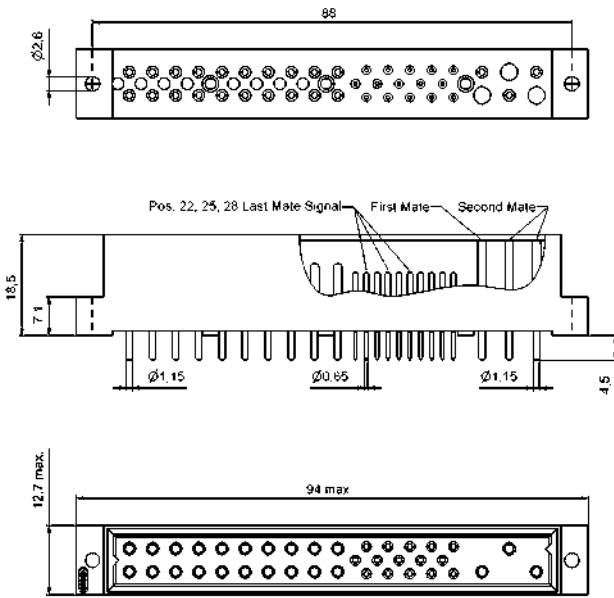

ORDER DATA

(Dim. = mm)

Number of positions	Contacts	Part number Quality class 3 (gold flash)	Part number Quality class 1 (0.8µm Au mating area)
38	15x signal / 23x power	CPH38 W23 MGRASK9 X	CPH38 W23 MGRCSK9 X

COMPACTPCI

Male connector – solder pin – straight – precision machined contacts – 47 positions

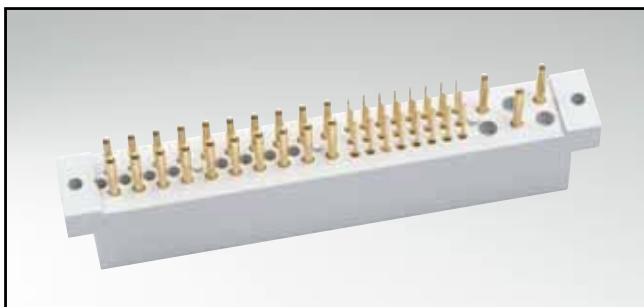

RoHS compliant – UL listed, File no.: E228329

DESCRIPTION

- Signal and power contacts
- 47 contacts, 24x signal / 23x power
- Sequential mating
- Contact plating quality class 1 or alternative quality class 3
- Special contact loadings possible on request

PRODUCT DRAWING

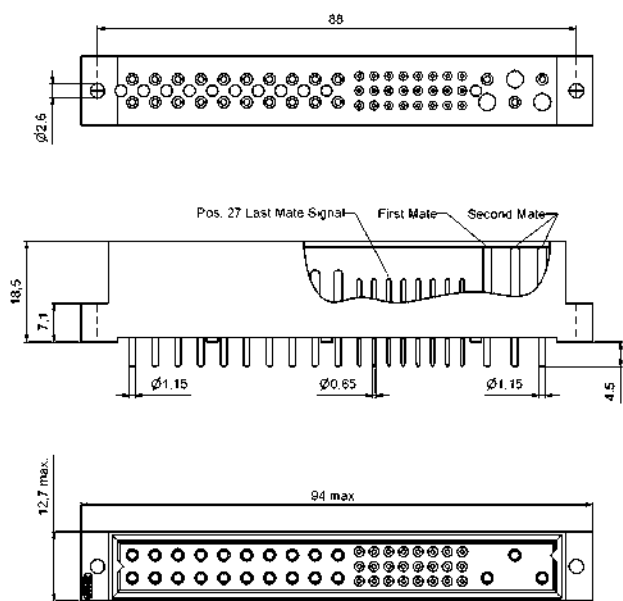

PCB-hole pattern

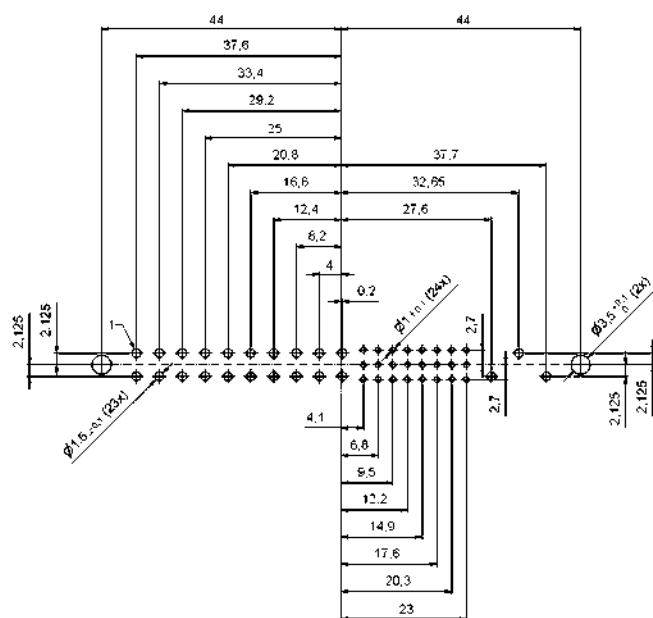

ORDER DATA

(Dim. = mm)

Number of positions	Contacts	Part number Quality class 3 (gold flash)	Part number Quality class 1 (0.8 μ m Au mating area)
47	24x signal / 23x power	CPH47 W23 MGRASK9 X	CPH47 W23 MGRCSK9 X

COMPACTPCI

Female connector – solder pin – straight – precision machined contacts – 38 positions

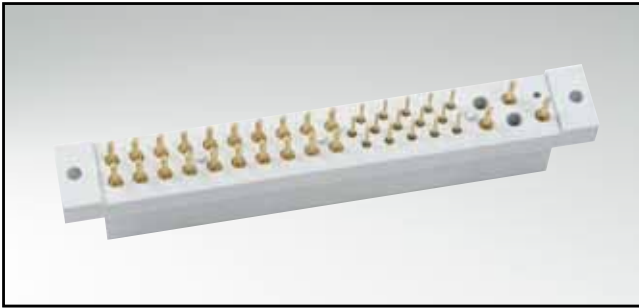

RoHS compliant – UL listed, File no.: E228329

DESCRIPTION

- Signal and power contacts
- 38 contacts, 15x signal / 23x power
- Sequential mating
- Contact plating quality class 1 or alternative quality class 3
- Special contact loadings possible on request

PRODUCT DRAWING

PCB-hole pattern

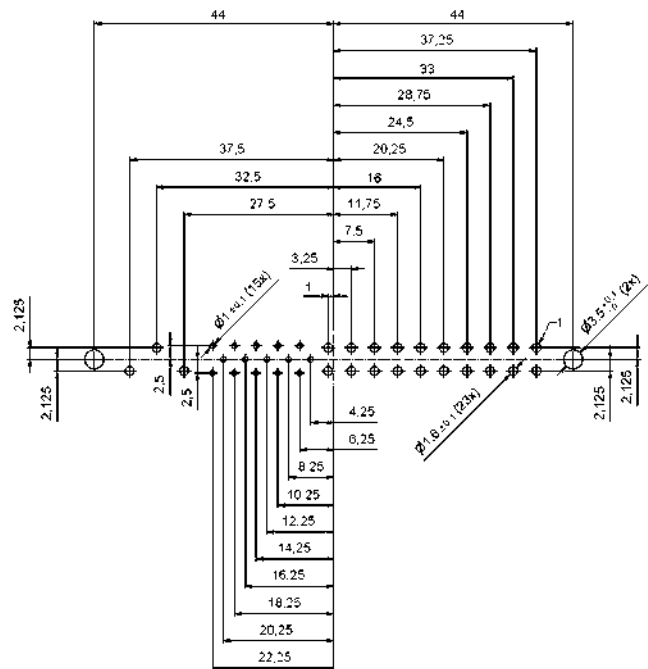
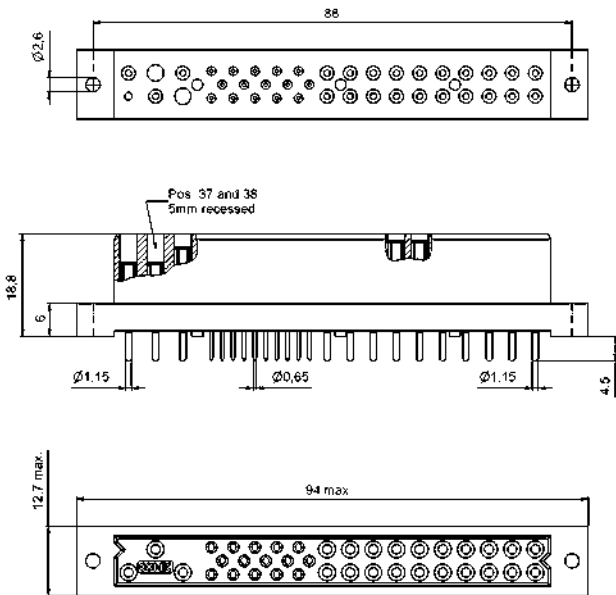

ORDER DATA

(Dim. = mm)

Number of positions	Contacts	Part number Quality class 3 (gold flash)	Part number Quality class 1 (0.8 μ m Au mating area)
38	15x signal / 23x power	CPH38 W23 FGRASK9 X	CPH38 W23 FGRCCK9 X

COMPACTPCI

Female connector – solder pin – straight – precision machined contacts – 38 positions

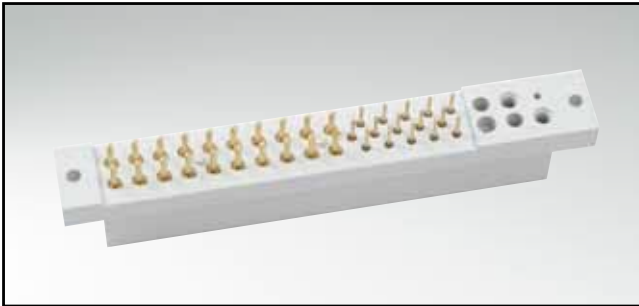

RoHS compliant – UL listed, File no.: E228329

DESCRIPTION

- Signal and power contacts
- Selectively loaded with 15x signal / 20x power
- Position 36 to 38 for crimp contacts (page 3 | 36)
- Contact plating quality class 1 or alternative quality class 3
- "Low Profile" area for crimp contacts
- Special contact loadings possible on request

PRODUCT DRAWING

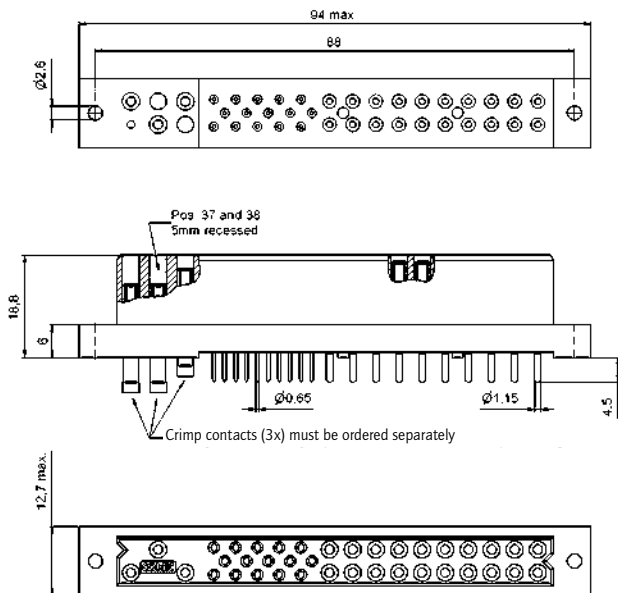

PCB-hole pattern

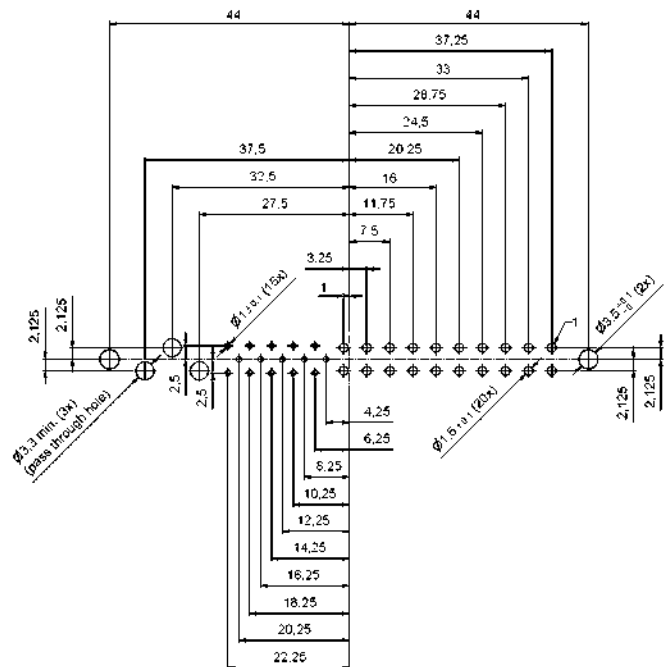

ORDER DATA

(Dim. = mm)

Number of positions	Contacts	Part number Quality class 3 (gold flash)	Part number Quality class 1 (0.8µm Au mating area)
38	15x signal / 20x power	CPH38 W23 FGRASN9 X	CPH38 W23 FGRCNS9 X

COMPACTPCI

Female connector – solder pin – straight – precision machined contacts – 38 positions

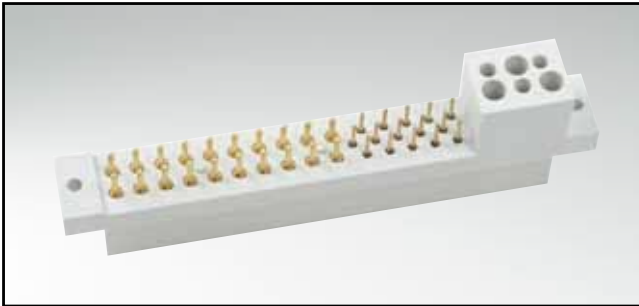

RoHS compliant – UL listed, File no.: E228329

DESCRIPTION

- Signal and power contacts
- Selectively loaded with 15x signal / 20x power
- Position 36 to 38 for crimp contacts (page 3 | 36)
- Contact plating quality class 1 or alternative quality class 3
- "High Profile", insulation support for crimp contacts
- Special contact loadings possible on request

PRODUCT DRAWING

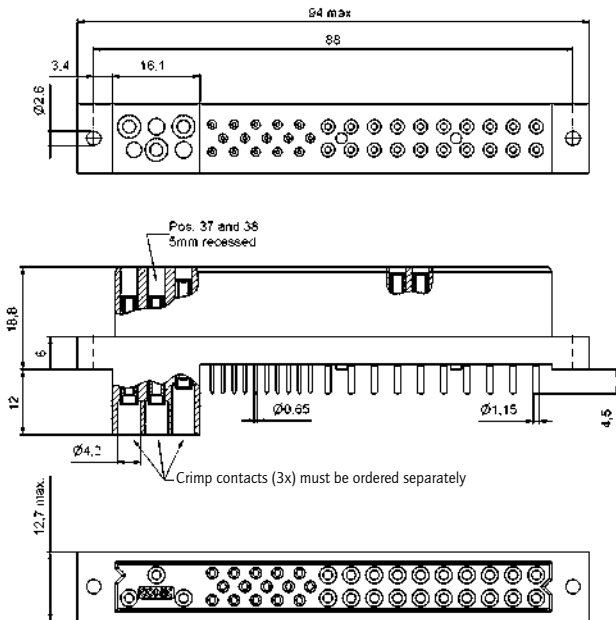

PCB-hole pattern

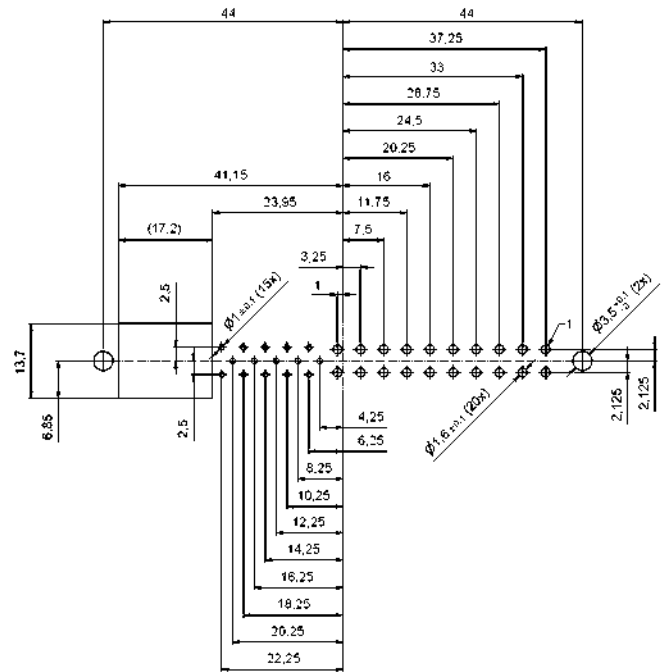

ORDER DATA

(Dim. = mm)

Number of positions	Contacts	Part number Quality class 3 (gold flash)	Part number Quality class 1 (0.8µm Au mating area)
38	15x signal / 20x power	CPH38 W23 FGRASH9 X	CPH38 W23 FGRC SH9 X

COMPACTPCI

Female connector – solder pin – straight – precision machined contacts – 47 positions

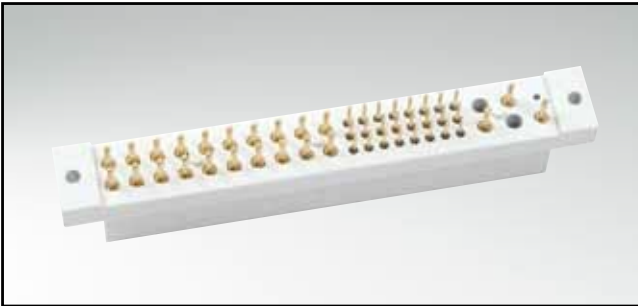

RoHS compliant – UL listed, File no.: E228329

DESCRIPTION

- Signal and power contacts
- 47 contacts, 24x signal / 23x power
- Sequential mating
- Contact plating quality class 1 or alternative quality class 3
- Special contact loadings possible on request

PRODUCT DRAWING

PCB-hole pattern

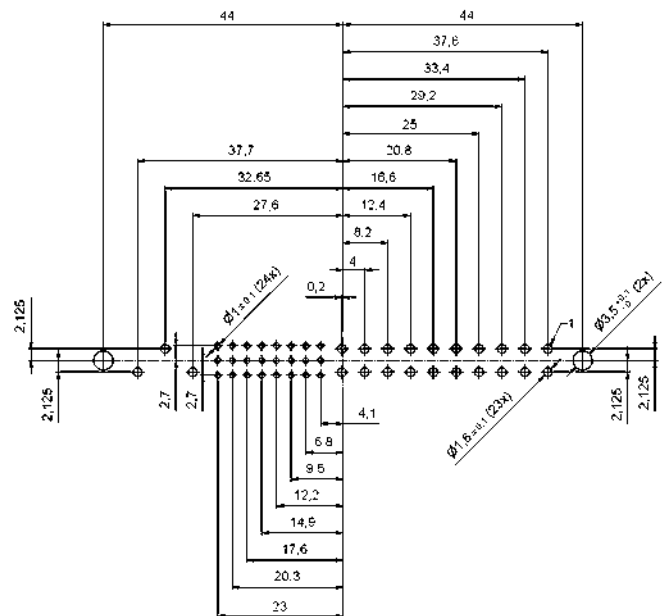
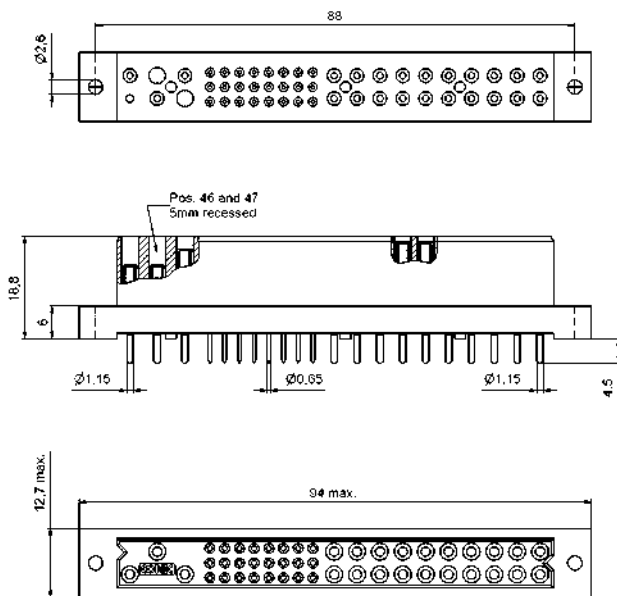

ORDER DATA

(Dim. = mm)

Number of positions	Contacts	Part number Quality class 3 (gold flash)	Part number Quality class 1 (0.8µm Au mating area)
47	24x signal / 23x power	CPH47 W23 FGRASK9 X	CPH47 W23 FGRCCK9 X

COMPACTPCI

Female connector – solder pin – straight – precision machined contacts – 47 positions

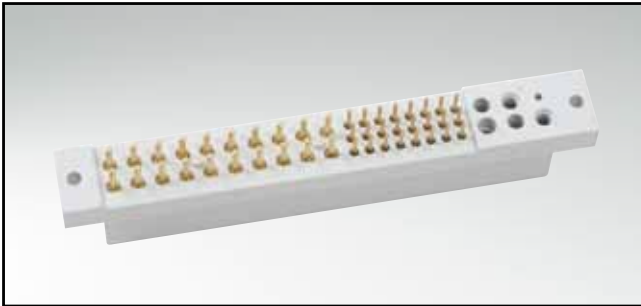

RoHS compliant – UL listed, File no.: E228329

DESCRIPTION

- Signal and power contacts
- Selectively loaded with 24x signal / 20x power
- Position 45 to 47 for crimp contacts (page 3 | 36)
- Contact plating quality class 1 or alternative quality class 3
- "Low Profile" area for crimp contacts
- Special contact loadings possible on request

PRODUCT DRAWING

PCB-hole pattern

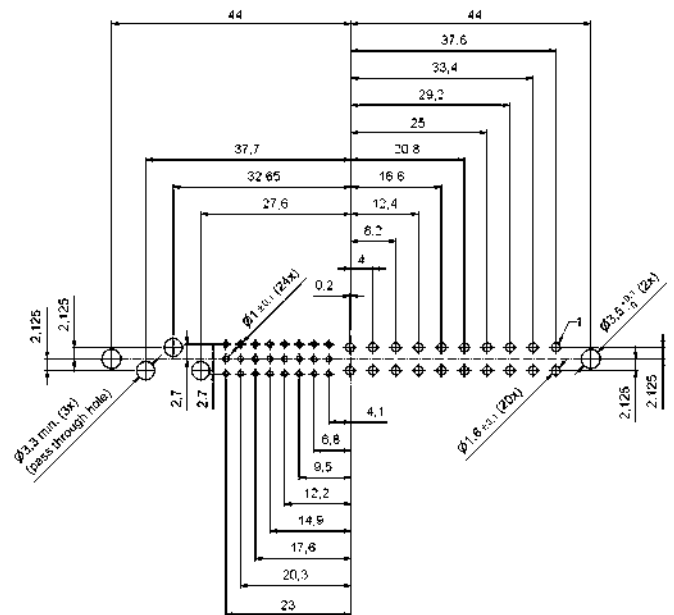
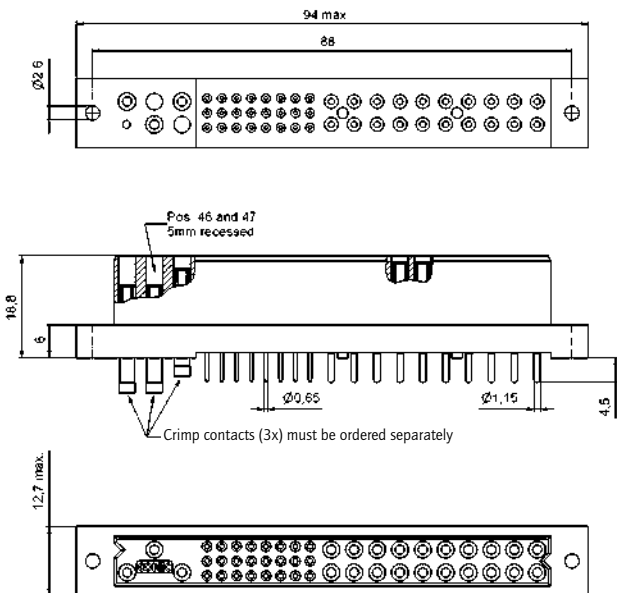

ORDER DATA

(Dim. = mm)

Number of positions	Contacts	Part number Quality class 3 (gold flash)	Part number Quality class 1 (0.8µm Au mating area)
47	24x signal / 20x power	CPH47 W23 FGRASN9 X	CPH47 W23 FGRCNS9 X

COMPACTPCI

Male connector – press fit – straight – precision machined contacts – 38 positions

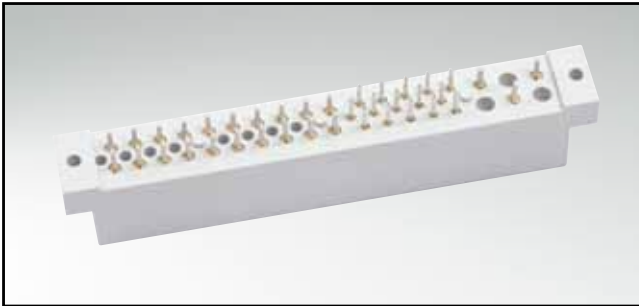

RoHS compliant – UL listed, File no.: E228329

DESCRIPTION

- Signal and power contacts
- 38 contacts, 15x signal / 23x power
- Sequential mating
- Eye of needle press fit design, tin plated
- Precision machined contact for the mating area
- Contact plating quality class 1 or alternative quality class 3
- Special contact loadings possible on request

PRODUCT DRAWING

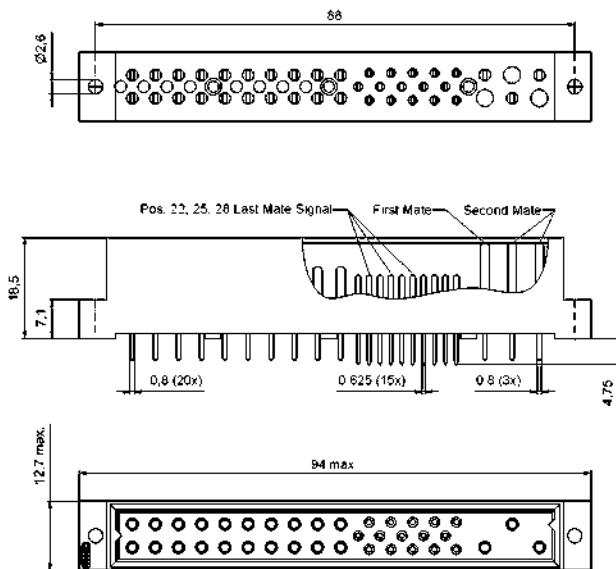

PCB-hole pattern

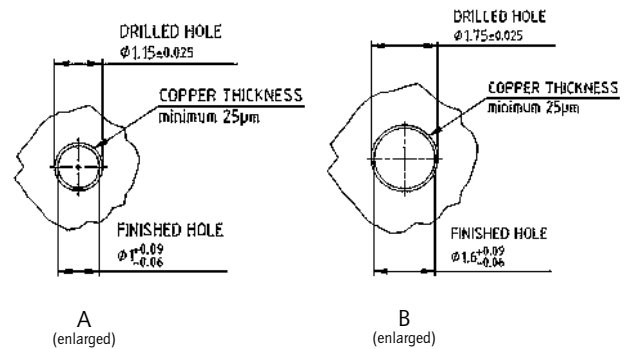
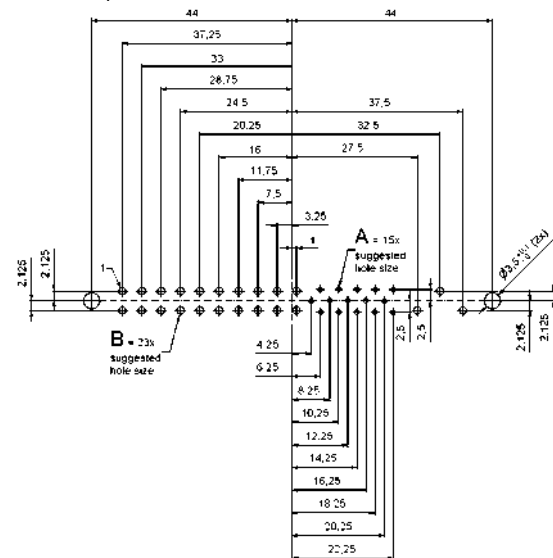

ORDER DATA

(Dim. = mm)

Number of positions	Contacts	Part number Quality class 3 (gold flash)	Part number Quality class 1 (0.8µm Au mating area)
38	15x signal / 23x power	CPH38 W23 MGE3SK9 X	CPH38 W23 MGE1SK9 X

COMPACTPCI

Male connector – press fit – straight – precision machined contacts – 47 positions

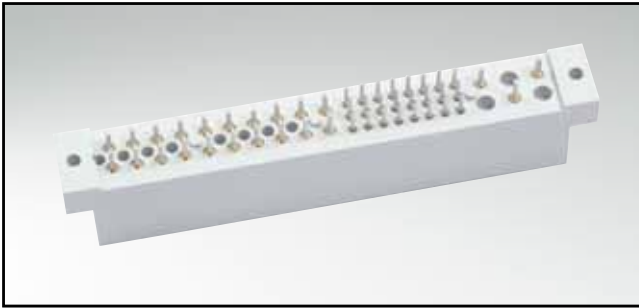

RoHS compliant – UL listed, File no.: E228329

DESCRIPTION

- Signal and power contacts
- 47 contacts, 24x signal / 23x power
- Sequential mating
- Eye of needle press fit design, tin plated
- Precision machined contact for the mating area
- Contact plating quality class 1 or alternative quality class 3
- Special contact loadings possible on request

PRODUCT DRAWING

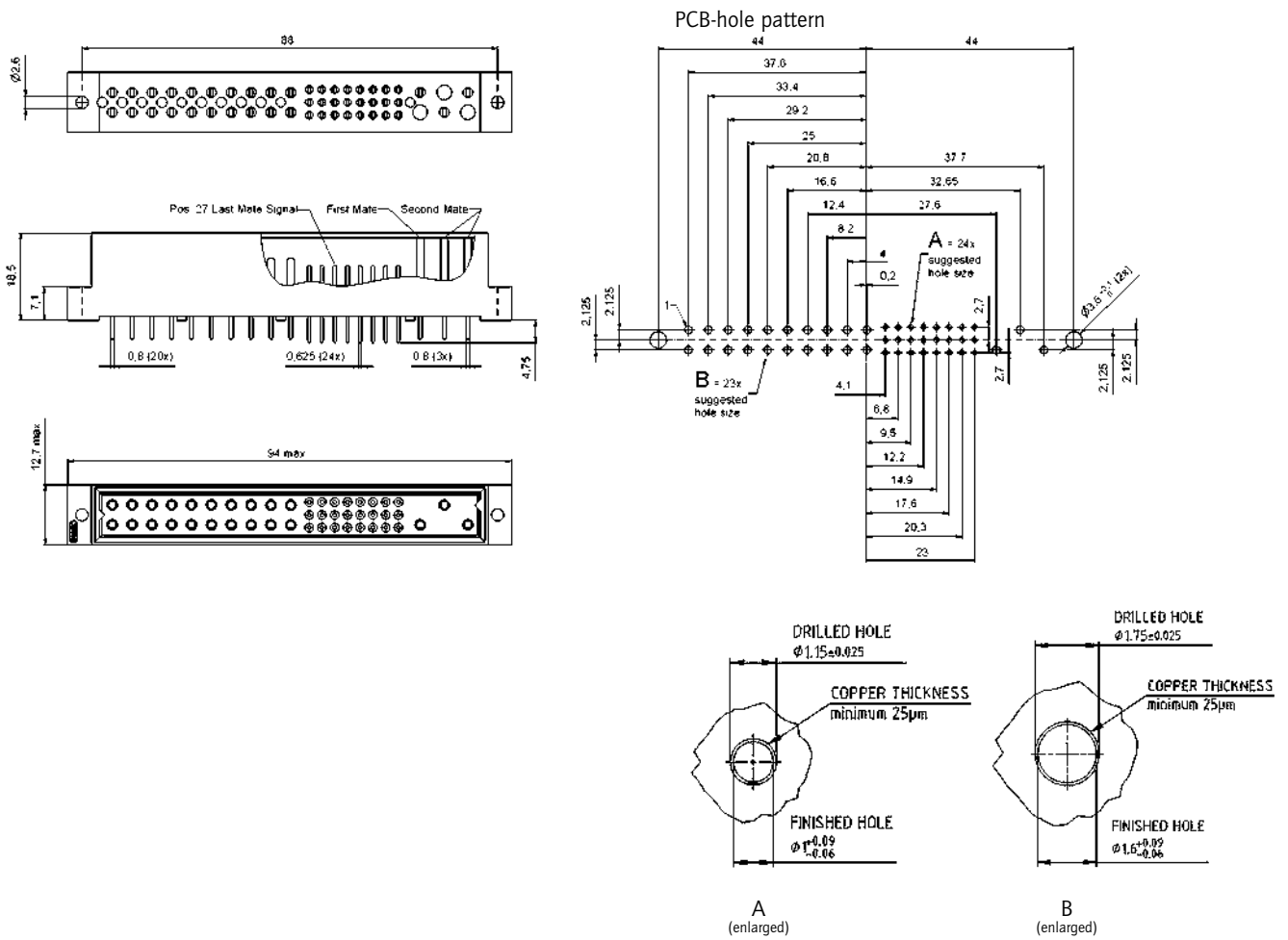

ORDER DATA

(Dim. = mm)

Number of positions	Contacts	Part number Quality class 3 (gold flash)	Part number Quality class 1 (0.8 μ m Au mating area)
47	24x signal / 23x power	CPH47 W23 MGE3SK9 X	CPH47 W23 MGE1SK9 X

COMPACTPCI

Female connector – press fit – straight – precision machined contacts – 38 positions

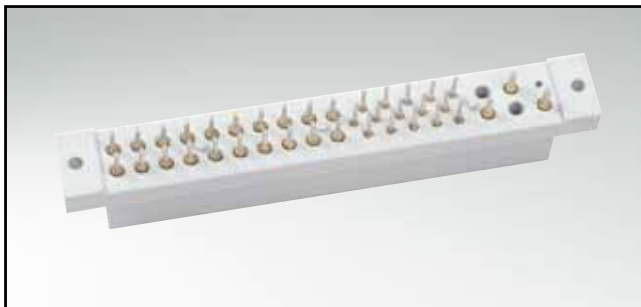

RoHS compliant – UL listed, File no.: E228329

DESCRIPTION

- Signal and power contacts
- 38 contacts, 15x signal / 23x power
- Sequential mating
- Eye of needle press fit design, tin plated
- Precision machined contact for the mating area
- Contact plating quality class 1 or alternative quality class 3
- Special contact loadings possible on request

PRODUCT DRAWING

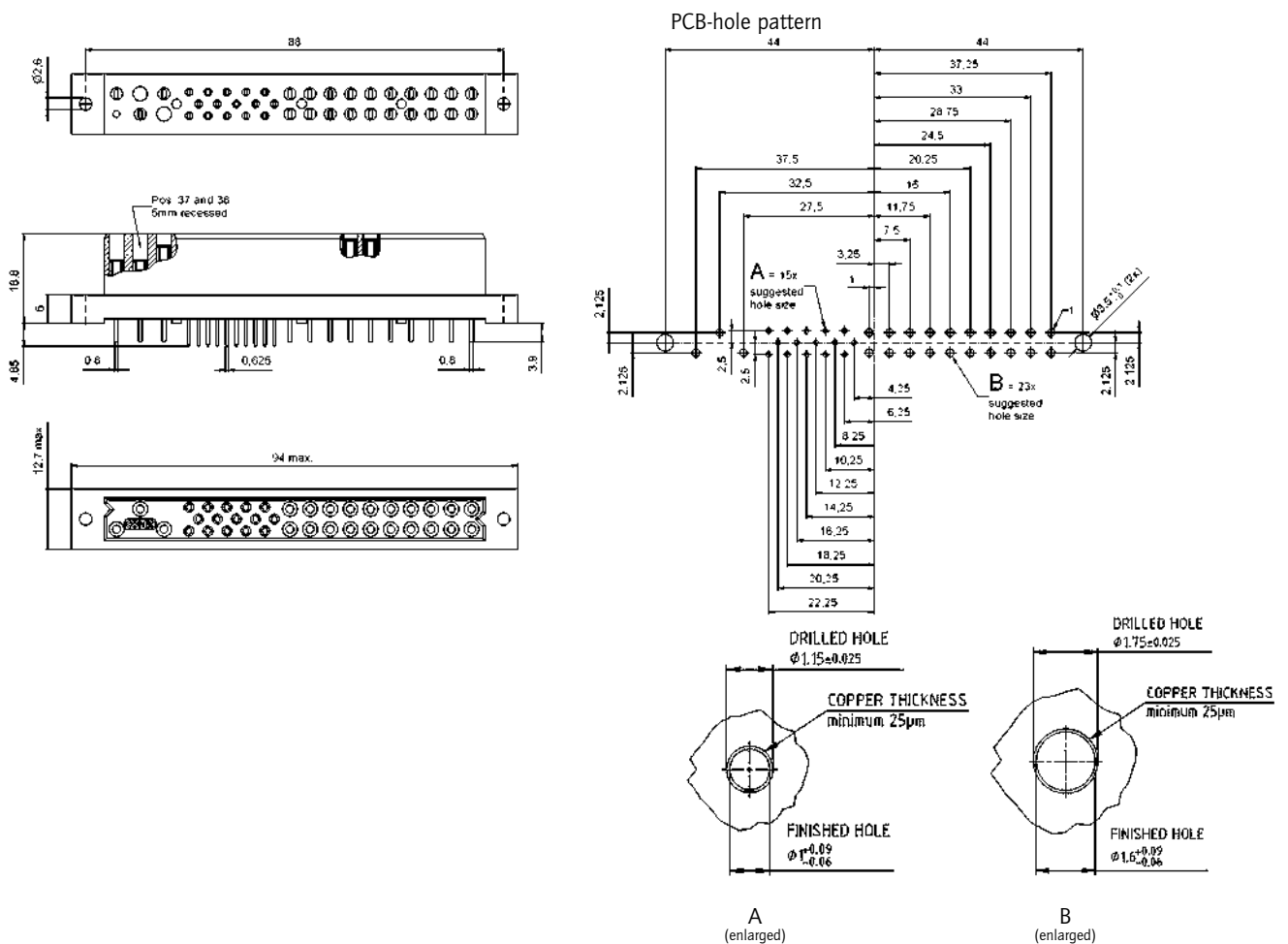

ORDER DATA

(Dim. = mm)

Number of positions	Contacts	Part number Quality class 3 (gold flash)	Part number Quality class 1 (0.8 μ m Au mating area)
38	15x signal / 23x power	CPH38 W23 FGE3SK9 X	CPH38 W23 FGE1SK9 X

COMPACTPCI

Female connector – press fit – straight – precision machined contacts – 38 positions

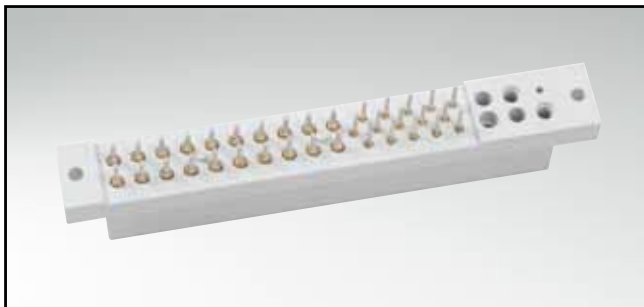

RoHS compliant – UL listed, File no.: E228329

DESCRIPTION

- Signal and power contacts
- Selectively loaded with 15x signal / 20x power
- Position 36 to 38 for crimp contacts (page 3 | 36)
- Eye of needle press fit design, tin plated
- Precision machined contact for the mating area
- Contact plating quality class 1 or alternative quality class 3
- "Low Profile" area for crimp contacts
- Special contact loadings possible on request

PRODUCT DRAWING

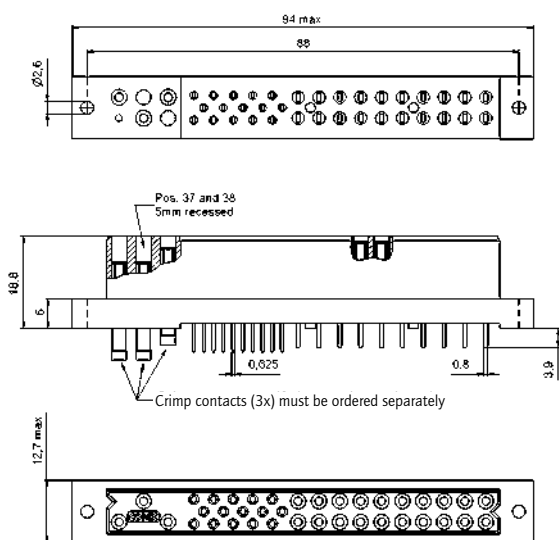

PCB-hole pattern

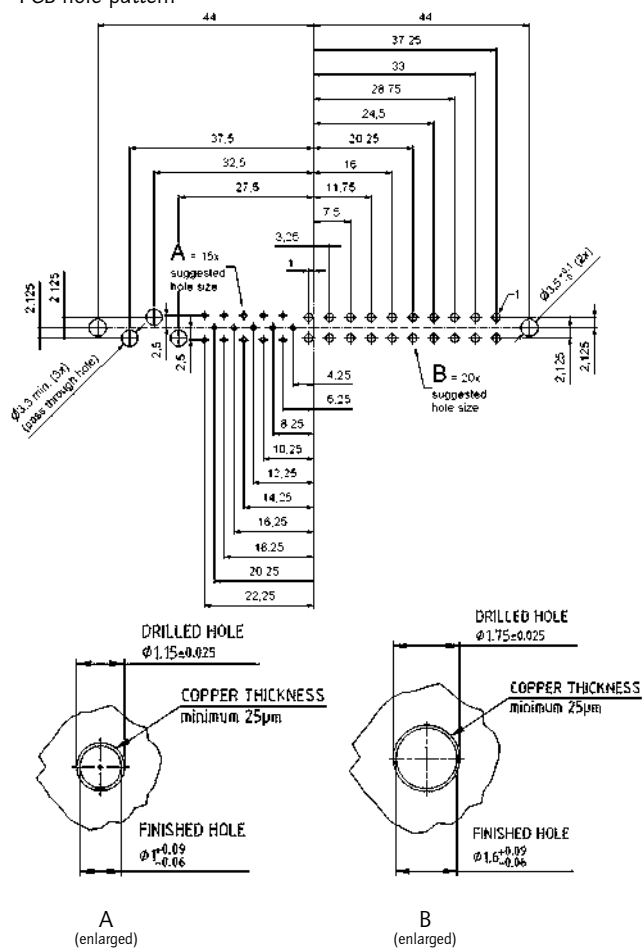

ORDER DATA

(Dim. = mm)

Number of positions	Contacts	Part number Quality class 3 (gold flash)	Part number Quality class 1 (0.8µm Au mating area)
38	15x signal / 20x power	CPH38 W23 FGE3SN9 X	CPH38 W23 FGE1SN9 X

COMPACTPCI

Female connector – press fit – straight – precision machined contacts – 38 positions

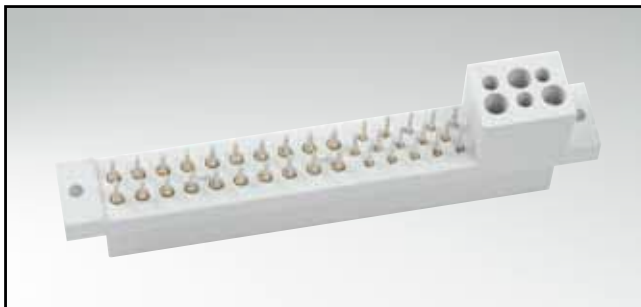

RoHS compliant – UL listed, File no.: E228329

DESCRIPTION

- Signal and power contacts
- Selectively loaded with 15x signal / 20x power
- Position 36 to 38 for crimp contacts (page 3 | 36)
- Eye of needle press fit design, tin plated
- Precision machined contact for the mating area
- Contact plating quality class 1 or alternative quality class 3
- "High Profile", insulation support for crimp contacts
- Special contact loadings possible on request

PRODUCT DRAWING

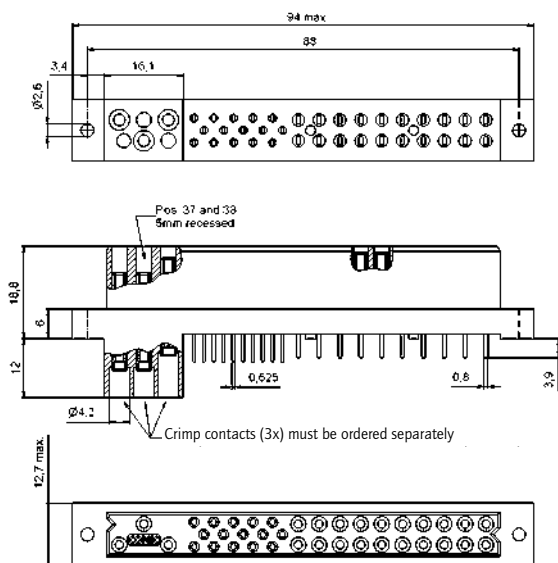

PCB-hole pattern

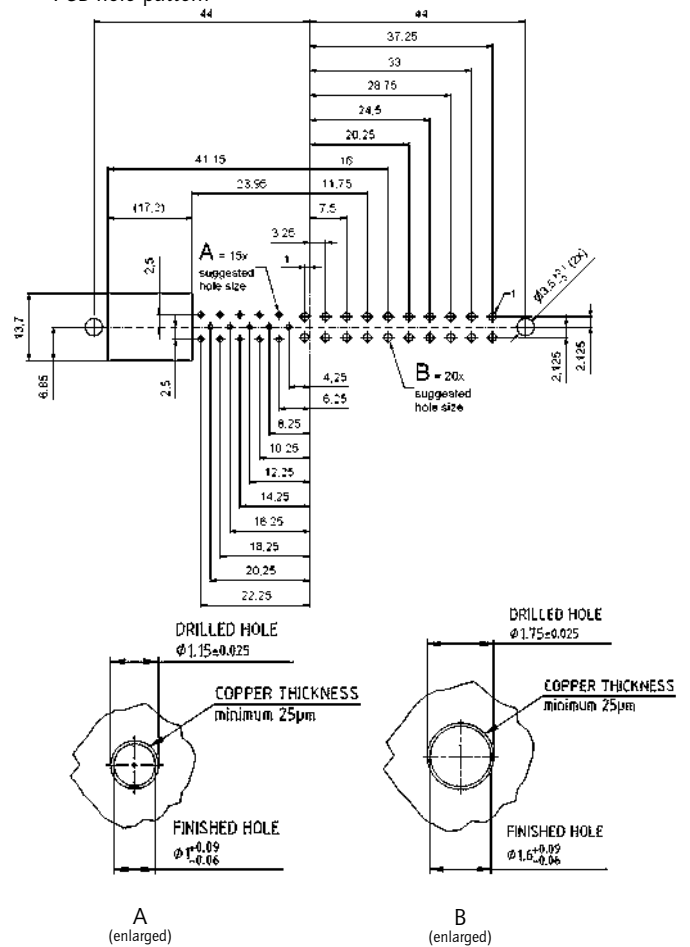

ORDER DATA

(Dim. = mm)

Number of positions	Contacts	Part number Quality class 3 (gold flash)	Part number Quality class 1 (0.8 μ m Au mating area)
38	15x signal / 20x power	CPH38 W23 FGE3SH9 X	CPH38 W23 FGE1SH9 X

COMPACTPCI

Female connector – press fit – straight – precision machined contacts – 47 positions

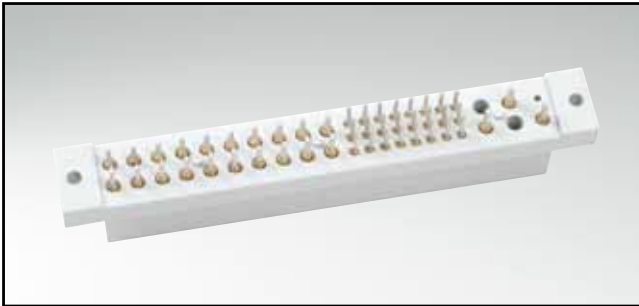

RoHS compliant – UL listed, File no.: E228329

DESCRIPTION

- Signal and power contacts
- 47 contacts, 24x signal / 23x power
- Sequential mating
- Eye of needle press fit design, tin plated
- Precision machined contact for the mating area
- Contact plating quality class 1 or alternative quality class 3
- Special contact loadings possible on request

PRODUCT DRAWING

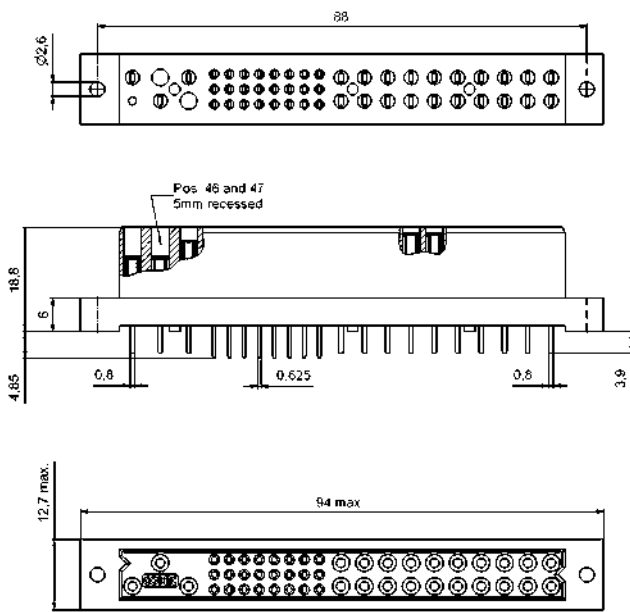

PCB-hole pattern

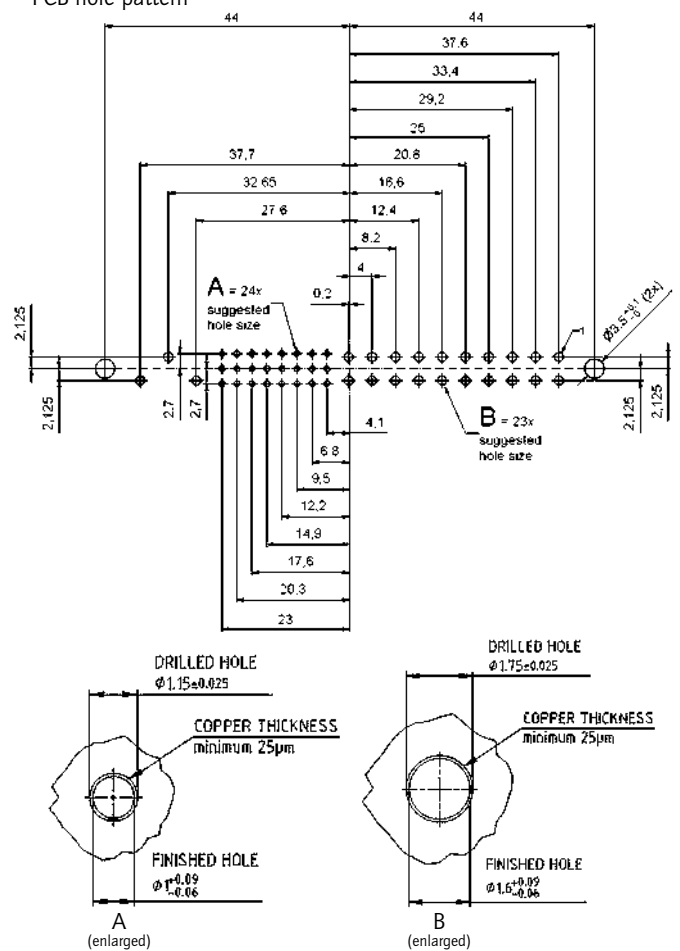

ORDER DATA

(Dim. = mm)

Number of positions	Contacts	Part number Quality class 3 (gold flash)	Part number Quality class 1 (0.8µm Au mating area)
47	24x signal / 23x power	CPH47 W23 FGE3SK9 X	CPH47 W23 FGE1SK9 X

COMPACTPCI

Female connector – press fit – straight – precision machined contacts – 47 positions

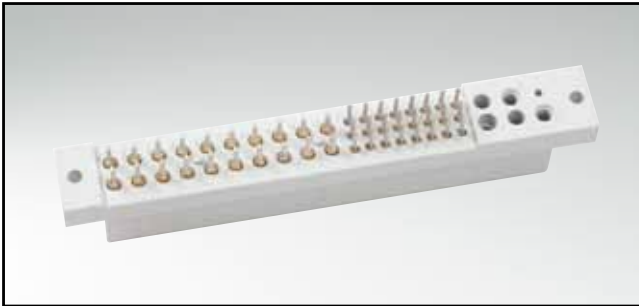

RoHS compliant – UL listed, File no.: E228329

DESCRIPTION

- Signal and power contacts
- Selectively loaded with 24x signal / 20x power
- Position 45 to 47 for crimp contacts (page 3 | 36)
- Eye of needle press fit design, tin plated
- Precision machined contact for the mating area
- Contact plating quality class 1 or alternative quality class 3
- "Low Profile" area for crimp contacts
- Special contact loadings possible on request

PRODUCT DRAWING

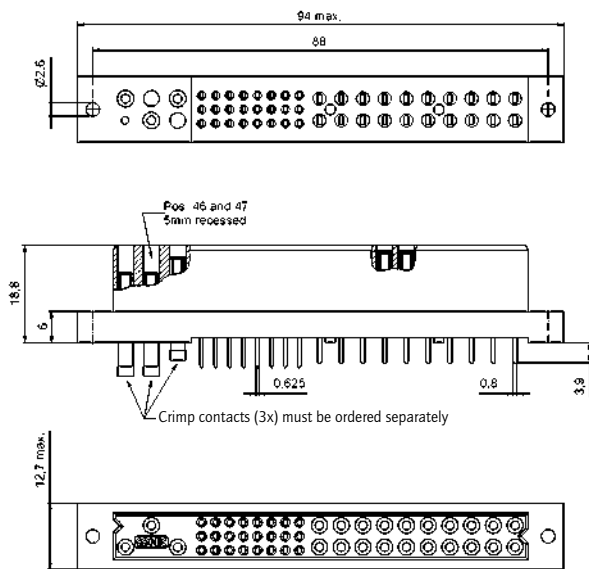

PCB-hole pattern

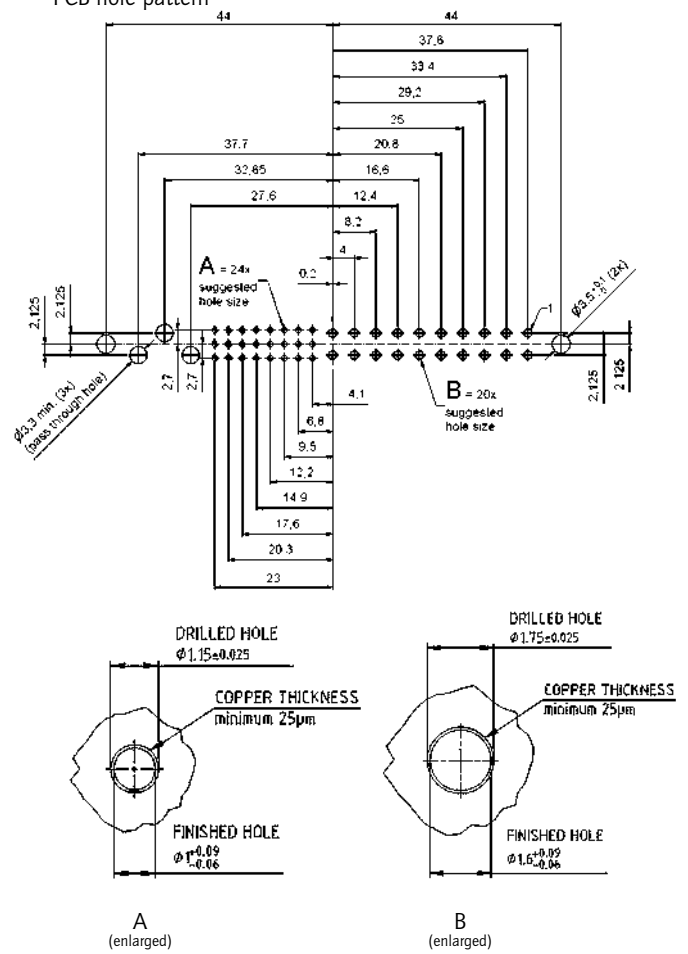

ORDER DATA

(Dim. = mm)

Number of positions	Contacts	Part number Quality class 3 (gold flash)	Part number Quality class 1 (0.8µm Au mating area)
47	24x signal / 20x power	CPH47 W23 FGE3SN9 X	CPH47 W23 FGE1SN9 X

COMPACTPCI

Female connector – press fit – straight – stamped contacts – 38 positions

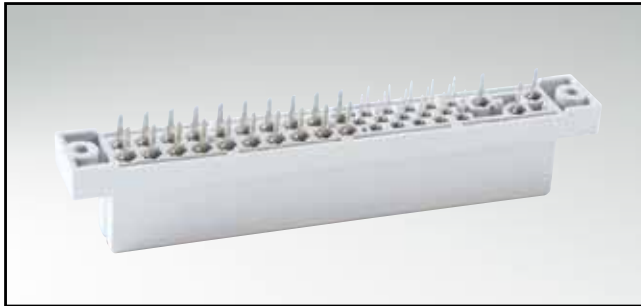

RoHS compliant

DESCRIPTION

- Signal and power contacts
- 38 contacts, 15x signal / 23x power
- Sequential mating
- Eye of needle press fit design, tin-plated
- Contact plating quality class 1 or alternative quality class 3
- Special contact loadings possible on request

PRODUCT DRAWING

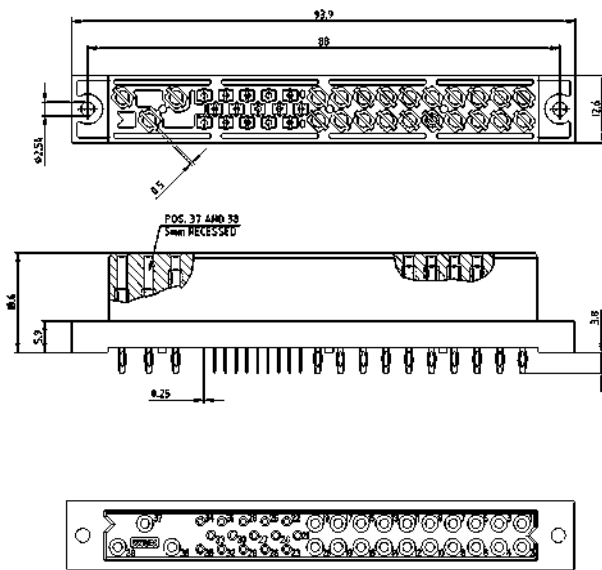

PCB-hole pattern

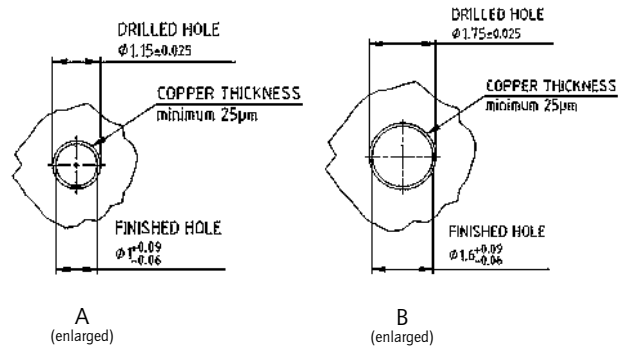
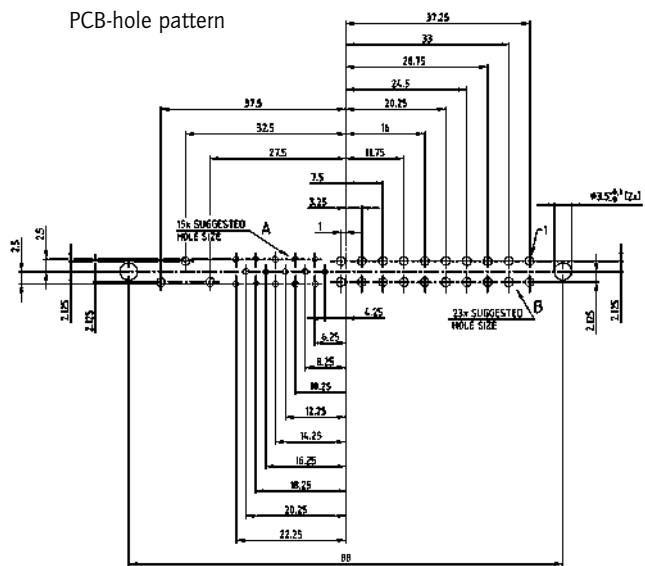

ORDER DATA

(Dim. = mm)

Number of positions	Contacts	Part number Quality class 3 (gold flash)	Part number Quality class 1 (0.8µm Au mating area)
38	15x signal / 23x power	45-000143	45-000141

COMPACTPCI

Female connector – press fit – straight – stamped contacts – 47 positions

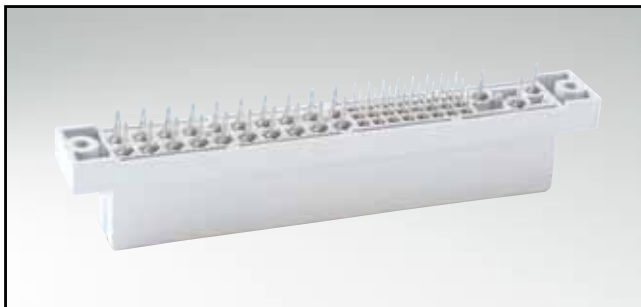

RoHS compliant

DESCRIPTION

- Signal and power contacts
- 47 contacts, 24x signal / 23x power
- Sequential mating
- Eye of needle press fit design, tin-plated
- Contact plating quality class 1 or alternative quality class 3
- Special contact loadings possible on request

PRODUCT DRAWING

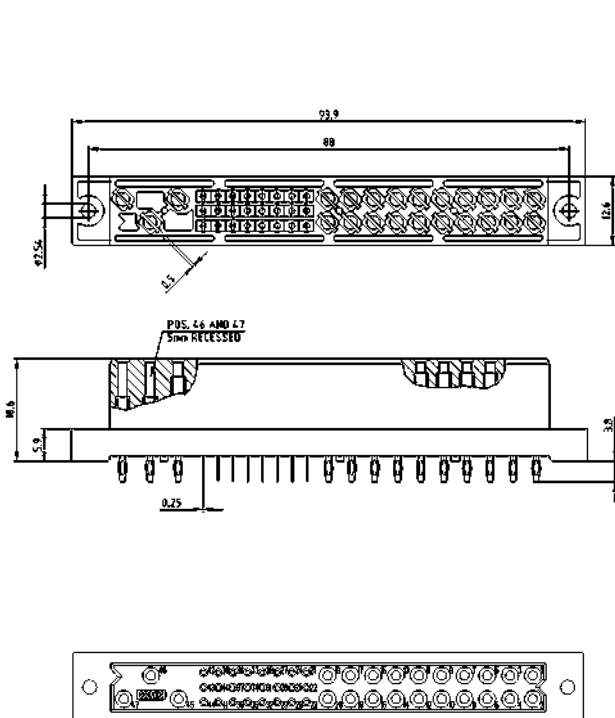

PCB-hole pattern

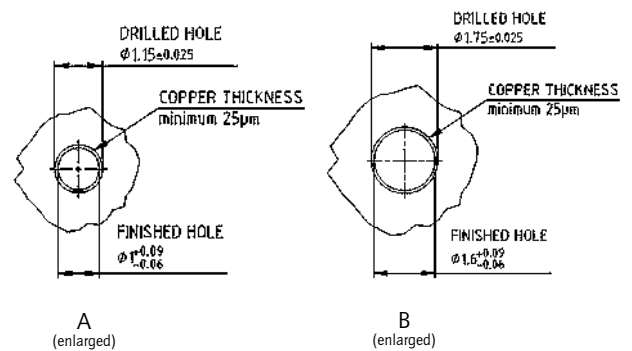
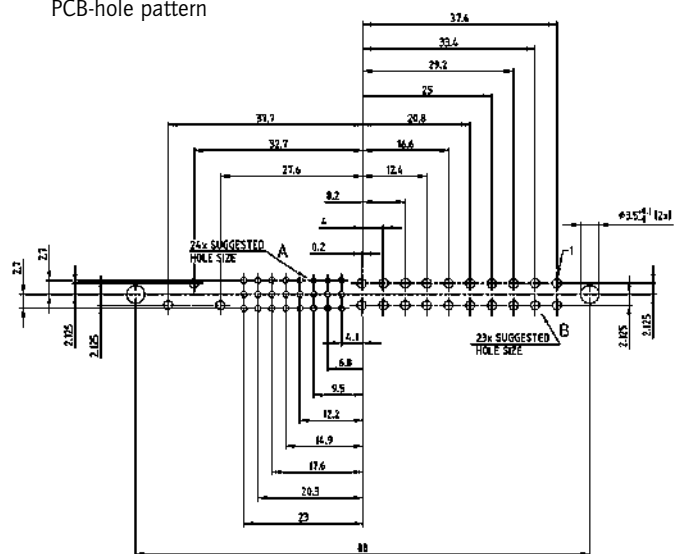

ORDER DATA

(Dim. = mm)

Number of positions	Contacts	Part number Quality class 3 (gold flash)	Part number Quality class 1 (0.8 μ m Au mating area)
47	24x signal / 23x power	45-000153	45-000151

COMPACTPCI

Female connector – press fit – straight – stamped – 47 positions

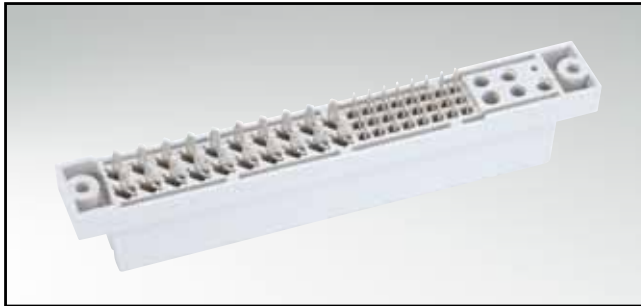

RoHS compliant

DESCRIPTION

- Signal and power contacts
- Selectively loaded with 24x signal / 20x power
- Position 45 to 47 for crimp contacts (page 3 | 36)
- Eye of needle press fit design, tin plated
- Contact plating quality class 1 or alternative quality class 3
- "Low Profile" area for crimp contacts
- Special contact loadings possible on request

PRODUCT DRAWING

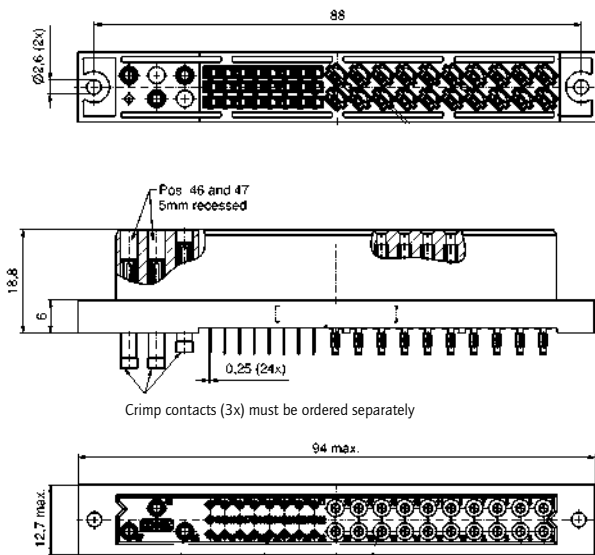

PCB-hole pattern

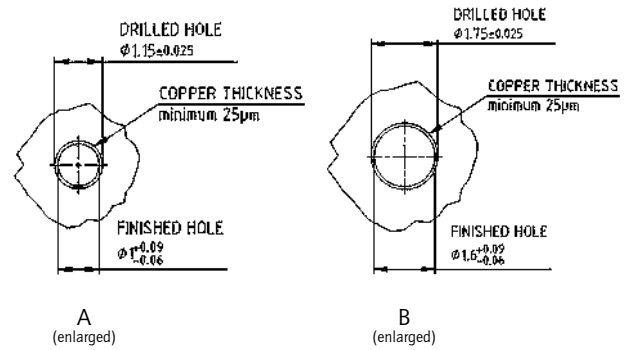
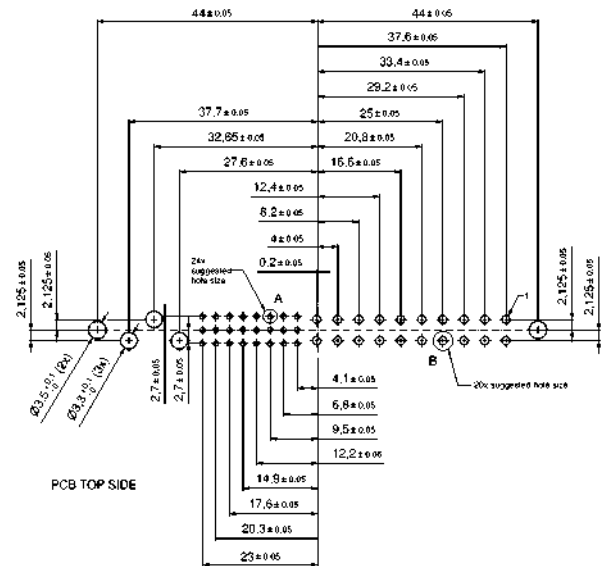

ORDER DATA

(Dim. = mm)

Number of positions	Contacts	Part number Quality class 3 (gold flash)	Part number Quality class 1 (0.8µm Au mating area)
47	24x signal / 20x power	45-000103	45-000101

COMPACTPCI

Female Connector – crimp version (without contacts) – 47 positions



RoHS compliant

DESCRIPTION

- For precision machined power- and signal contacts
- Power contacts are suitable for wire size AWG 12 to 24
- Signal contacts are suitable for wire size AWG 22
- For crimp contacts please see page 3 | 36

PRODUCT DRAWING

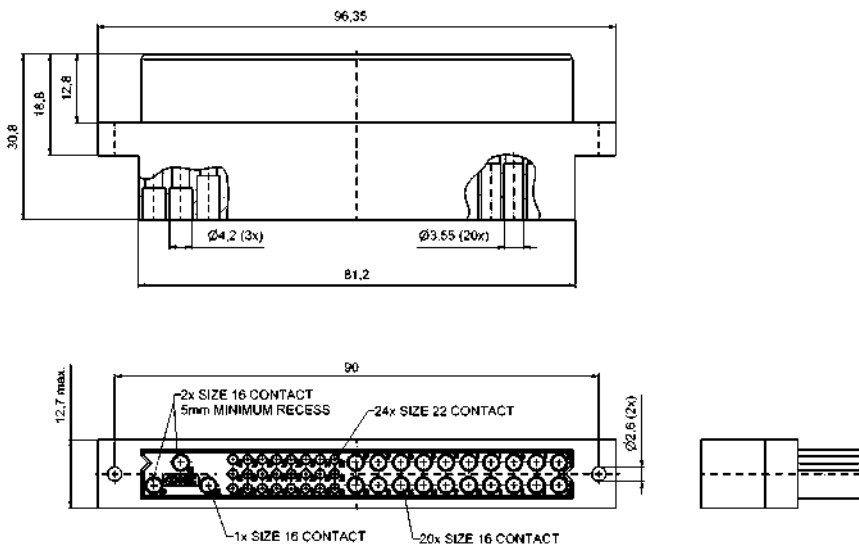

ORDER DATA

(Dim. = mm)

Number of positions	Part number
47	CPH 47W23 FXXXSH9 X

COMPACTPCI

Power and Signal crimp contacts – precision machined version



RoHS compliant

DESCRIPTION

- Power contacts are suitable for wire size AWG 12 to 24
- Signal contacts are suitable for wire size AWG 22
- Crimp tools see section 9
- Suitable connectors on page 3 | 16, 3 | 17, 3 | 21, 3 | 22, 3 | 24, 3 | 28, 3 | 29, 3 | 34 and 3 | 35
- Gold plated quality class 1 or alternative quality class 3

PRODUCT DRAWING

Power crimp contact

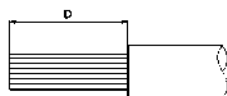
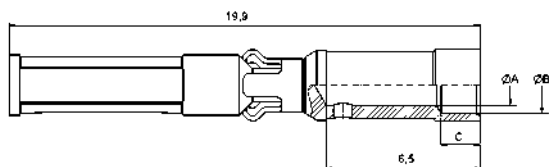

Cable stripping dimensions

Signal crimp contact

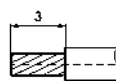
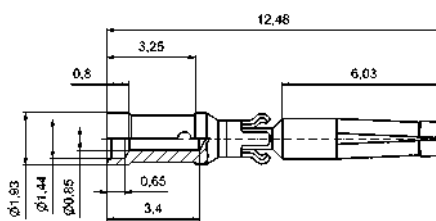

Cable stripping dimensions

for wire size	A	B	C	D
AWG 12	2.49	-	-	6.5
AWG 14-16	2.06	2.67	1.65	5.0
AWG 16-18	1.70	2.36	1.65	5.0
AWG 20-22-24	1.14	1.72	1.65	5.0

ORDER DATA

(Dim. = mm)

for wire size	Part number Quality class 3 (gold flash)	Part number Quality class 1 (0.8µm Au mating area)
Power crimp AWG 12	CPZC 1612FA X	CPZC 1612FC X
Power crimp AWG 14-16	CPZC 1614FA X	CPZC 1614FC X
Power crimp AWG 16-18	CPZC 1616FA X	CPZC 1616FC X
Power crimp AWG 20-22-24	CPZC 1620FA X	CPZC 1620FC X
Signal crimp AWG 22	CPZC 0822FA X	CPZC 0822FC X

COMPACTPCI / ADVANCEDTCA

Mounting screws



RoHS compliant

DESCRIPTION

- Mounting screws for PCB
- Material: steel, nickel-plated
- Different length for different PCB thicknesses

PRODUCT DRAWING

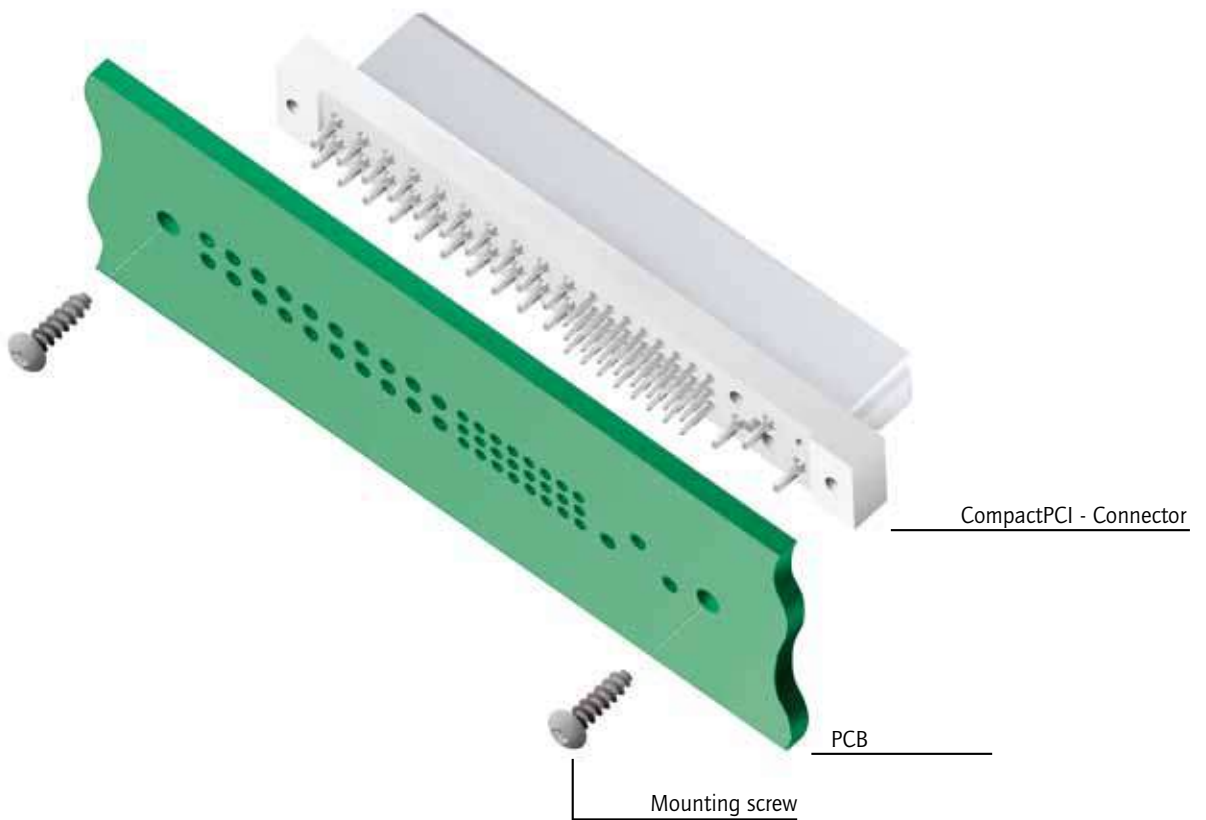

ORDER DATA

(Dim. = mm)

Screw for CompactPCI	Thread length	Screw for AdvancedTCA	Thread length
CPZS 0170 X	8.1 mm	CPZS 5170 X	6.0 mm
CPZS 0270 X	10.1 mm	CPZS 5270 X	8.0 mm
CPZS 0370 X	11.1 mm	CPZS 5370 X	10.0 mm
CPZS 0470 X	12.7 mm	CPZS 5470 X	12.0 mm

MINI POWER

Male Connector – solder pin – angled – precision machined contacts – 24 positions

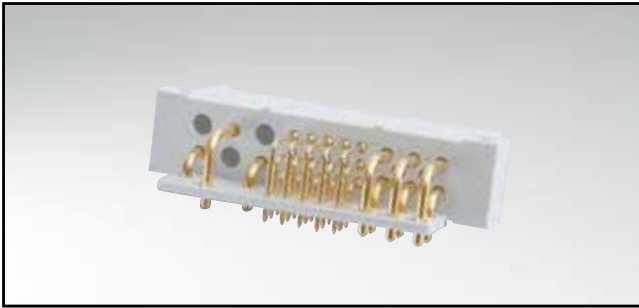

RoHS compliant

DESCRIPTION

- Signal and power contacts
- 24 contacts, 15x signal / 9x power
- Sequential mating
- Contact plating quality class 1 or alternative quality class 3
- Special contact loadings possible on request

PRODUCT DRAWING

PCB-hole pattern

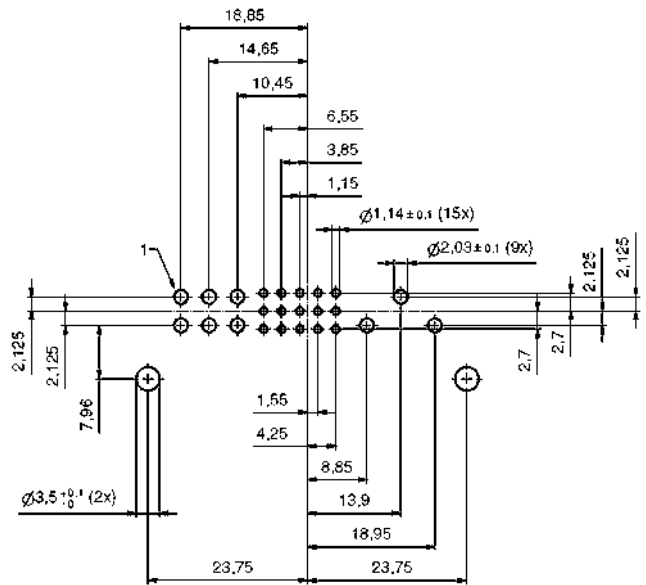
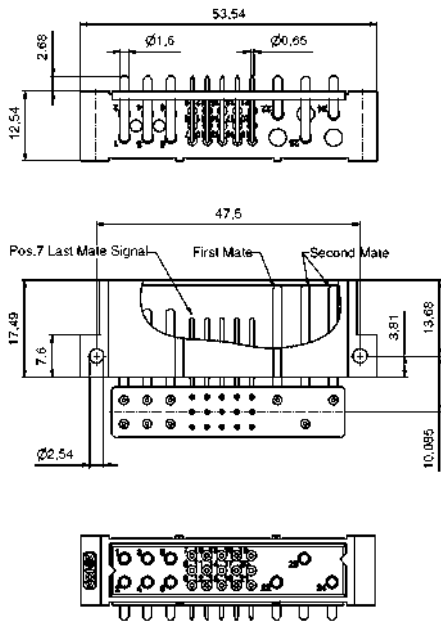

ORDER DATA

(Dim. = mm)

Number of positions	Contacts	Part number Quality class 3 (gold flash)	Part number Quality class 1 (0.8 μ m Au mating area)
24	15x signal / 9x power	CPD24 W09 MARASK9 X	CPD24 W09 MARCSK9 X

MINI POWER

Male connector – solder pin – angled – precision machined contacts – 26 positions

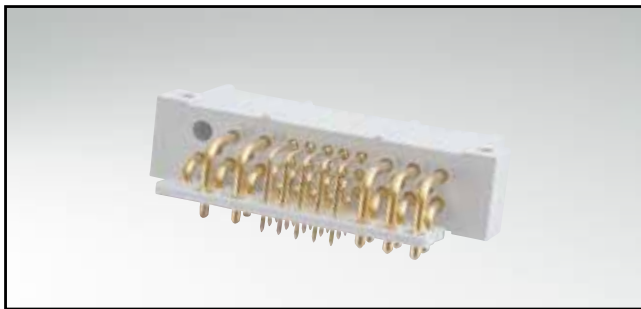

RoHS compliant

DESCRIPTION

- Signal and power contacts
- 26 contacts, 15x signal / 11x power
- Sequential mating
- Contact plating quality class 1 or alternative quality class 3
- Special contact loadings possible on request

PRODUCT DRAWING

PCB-hole pattern

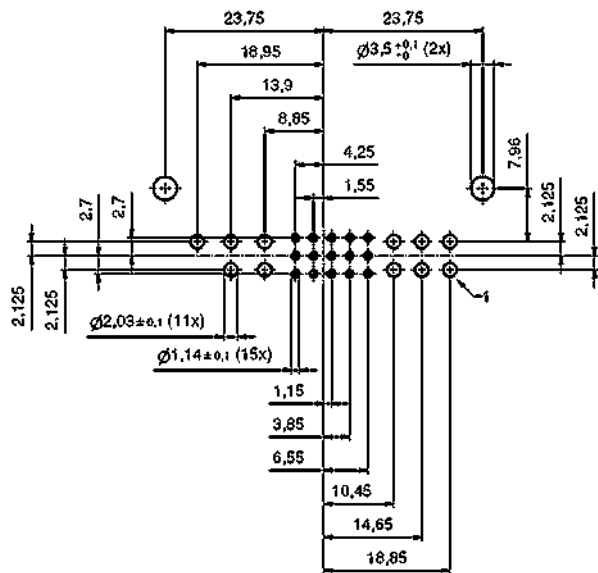
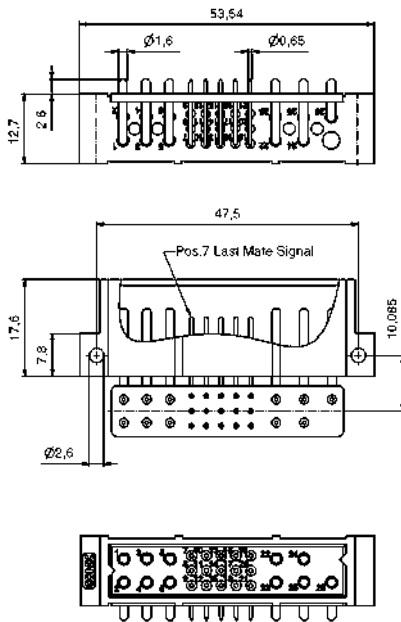

ORDER DATA

(Dim. = mm)

Number of positions	Contacts	Part number Quality class 3 (gold flash)	Part number Quality class 1 (0.8µm Au mating area)
26	15x signal / 11x power	CPD26 W11 MARASK9 X	CPD26 W11 MARCSK9 X

MINI POWER

Male connector – solder pin – straight – precision machined contacts – 24 positions

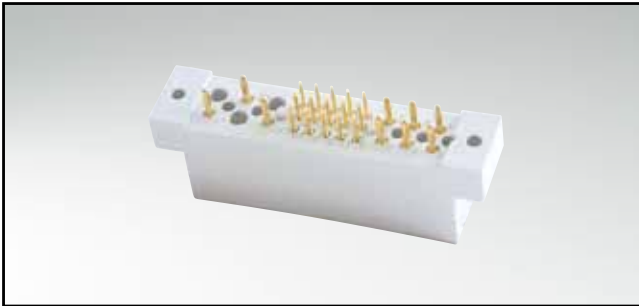

RoHS compliant

DESCRIPTION

- Signal and power contacts
- 24 contacts, 15x signal/9x power
- Sequential mating
- Contact plating quality class 1 or alternative quality class 3
- Special contact loadings possible on request

PRODUCT DRAWING

PCB-hole pattern

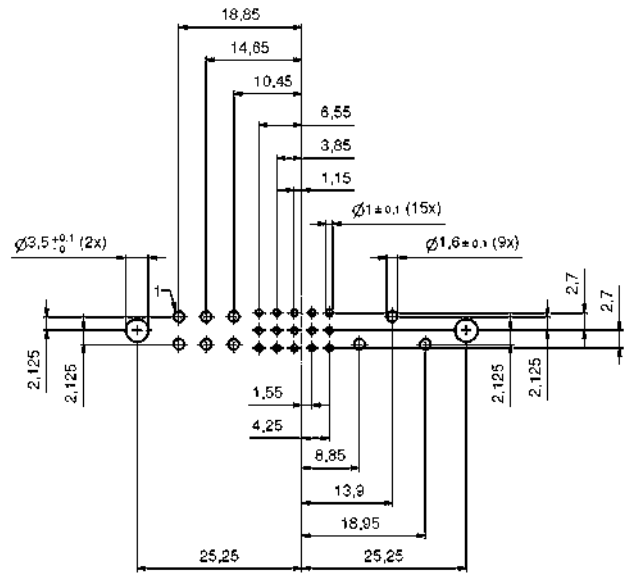
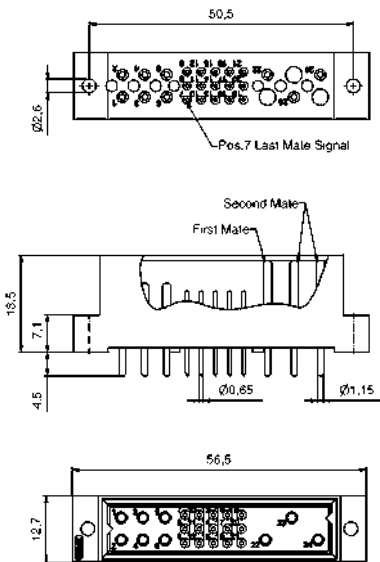

ORDER DATA

(Dim. = mm)

Number of positions	Contacts	Part number Quality class 3 (gold flash)	Part number Quality class 1 (0.8µm Au mating area)
24	15x signal/9x power	CPD24 W09 MGRASK9 X	CPD24 W09 MGRCSK9 X

MINI POWER

Male connector – solder pin – straight – precision machined contacts – 26 positions

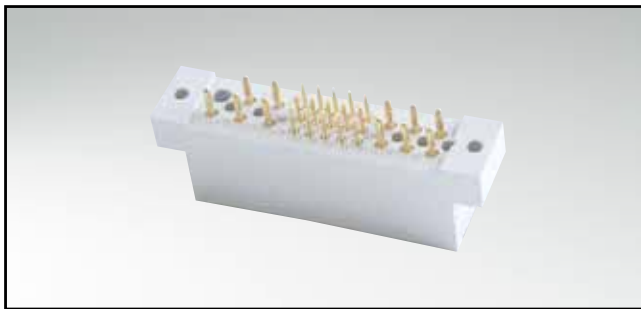

RoHS compliant

DESCRIPTION

- Signal and power contacts
- 26 contacts, 15x signal / 11x power
- Sequential mating
- Contact plating quality class 1 or alternative quality class 3
- Special contact loadings possible on request

PRODUCT DRAWING

PCB-hole pattern

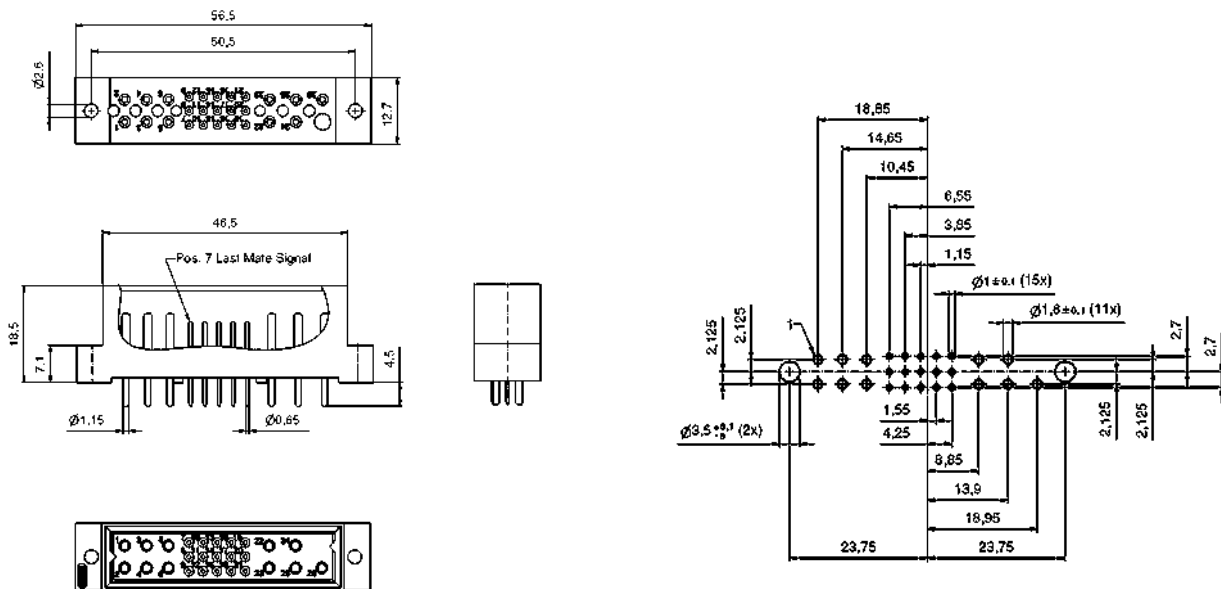

ORDER DATA

(Dim. = mm)

Number of positions	Contacts	Part number Quality class 3 (gold flash)	Part number Quality class 1 (0.8µm Au mating area)
26	15x signal / 11x power	CPD26 W11 MGRASK9 X	CPD26 W11 MGRCSK9 X

MINI POWER

Female connector – press fit – straight – stamped – 24 positions

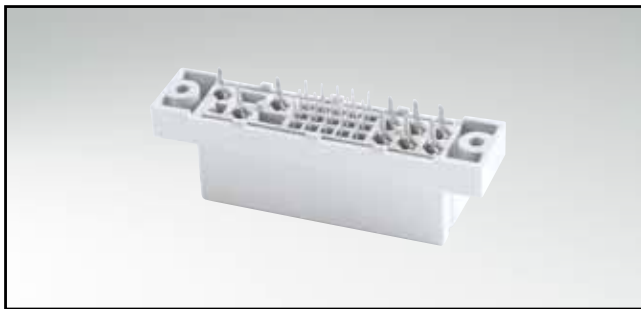

RoHS compliant

DESCRIPTION

- Signal and power contacts
- 24 contacts, 15x signal / 9x power
- Sequential mating
- Eye of needle press fit design, tin-plated
- Contact plating quality class 1 or alternative quality class 3
- Special contact loadings possible on request

PRODUCT DRAWING

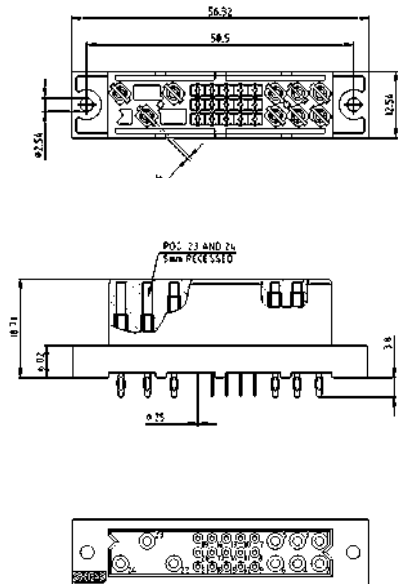

PCB-hole pattern

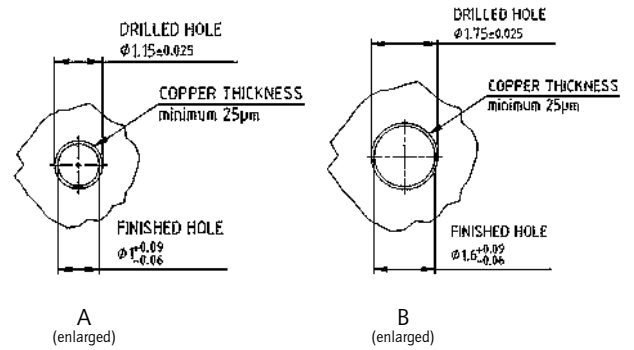
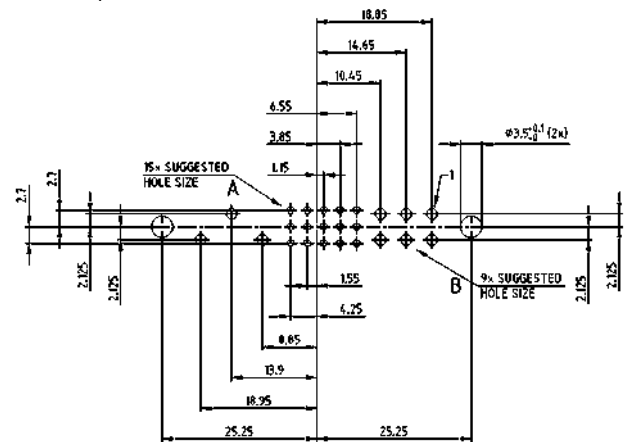

ORDER DATA

(Dim. = mm)

Number of positions	Contacts	Part number Quality class 3 (gold flash)	Part number Quality class 1 (0.8µm Au mating area)
24	15x signal / 9x power	45-000123	45-000121

MINI POWER

Female connector – press fit – straight – stamped contacts – 26 positions

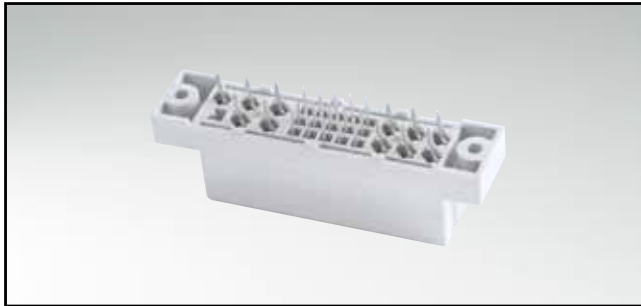

RoHS compliant

DESCRIPTION

- Signal and power contacts
- 26 contacts, 15x signal / 11x power
- Sequential mating
- Eye of needle press fit design, tin-plated
- Contact plating quality class 1 or alternative quality class 3
- Special contact loadings possible on request

PRODUCT DRAWING

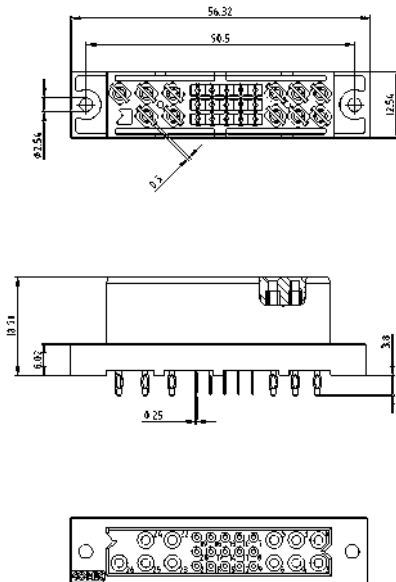

PCB-hole pattern

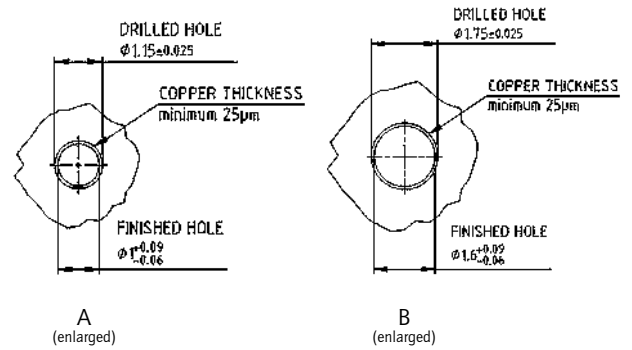
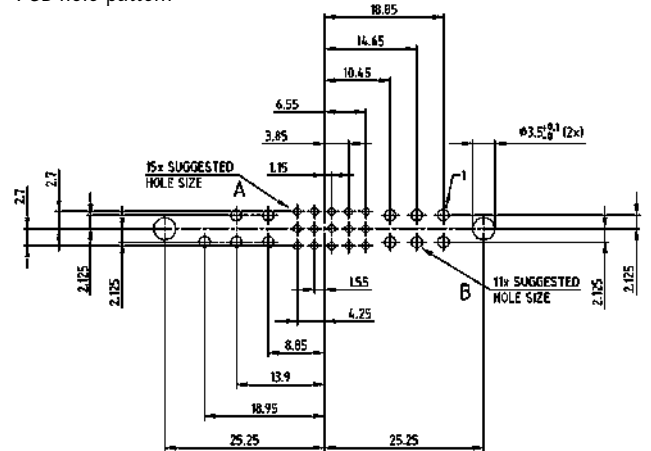

(Dim. = mm)

ORDER DATA

Number of positions	Contacts	Part number Quality class 3 (gold flash)	Part number Quality class 1 (0.8µm Au mating area)
26	15x signal / 11x power	45-000133	45-000131

SECTION 4

CONNECTORS DIN EN 60603-2

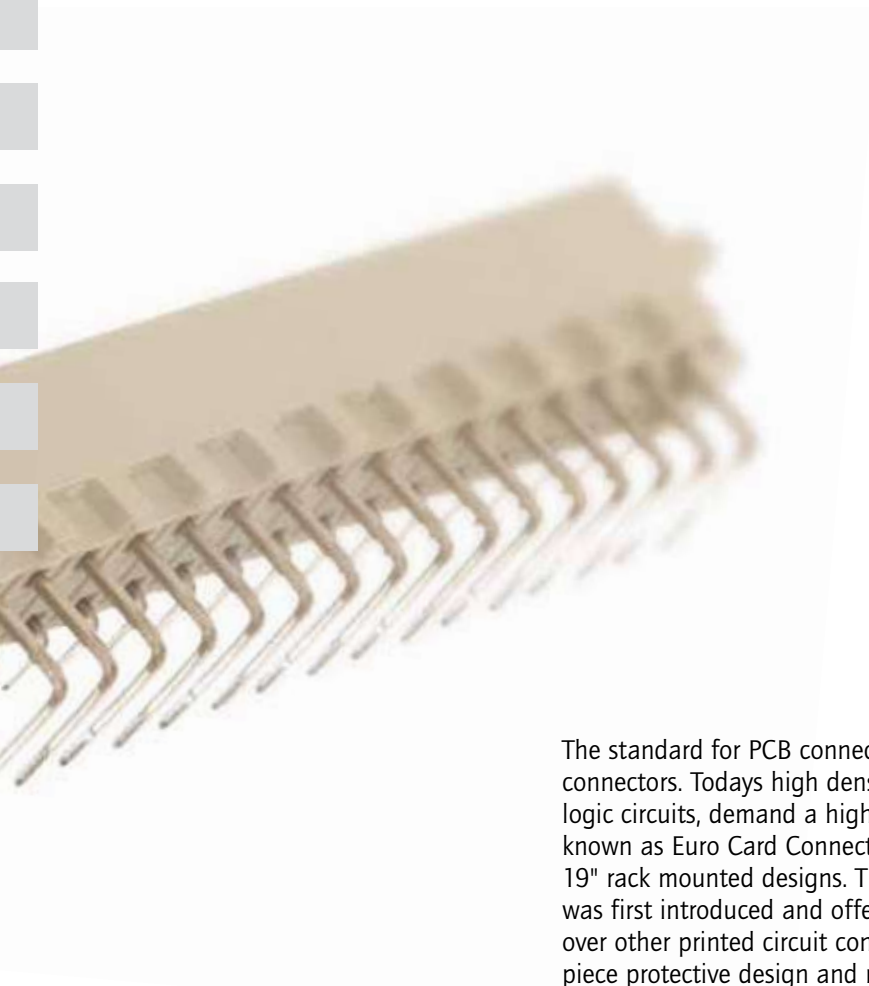

The standard for PCB connectors has been set by the DIN EN 60603-2 two piece connectors. Today's high density packing applications, combined with high speed logic circuits, demand a high reliability interconnection system. The series is also known as Euro Card Connectors, gained popularity due to the similarity with 19" rack mounted designs. The product family has grown over the years since it was first introduced and offers significant improvements in performance and design over other printed circuit connectors. High contact density, low mating force, two piece protective design and many contact termination styles offer unlimited design applications.

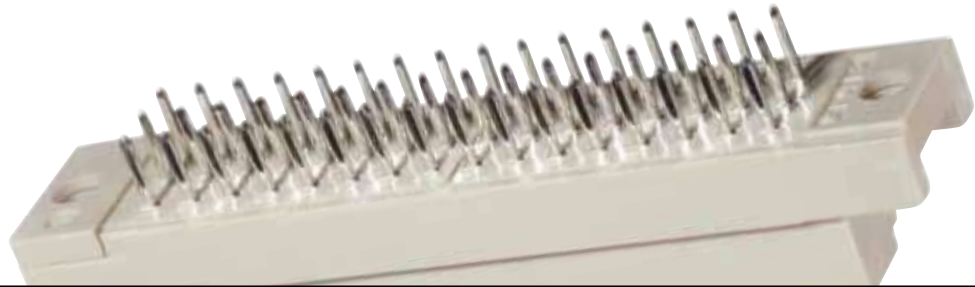

CONEC manufactures a wide range of products; series B, C, R, D, E, F, G, H and half size types are also available. Termination methods include: PCB direct soldering, solder eyelet, wire wrap, crimp, faston terminals and screw terminals.

In addition, we manufacture custom products or variations to existing designs with short design cycle and turn around.

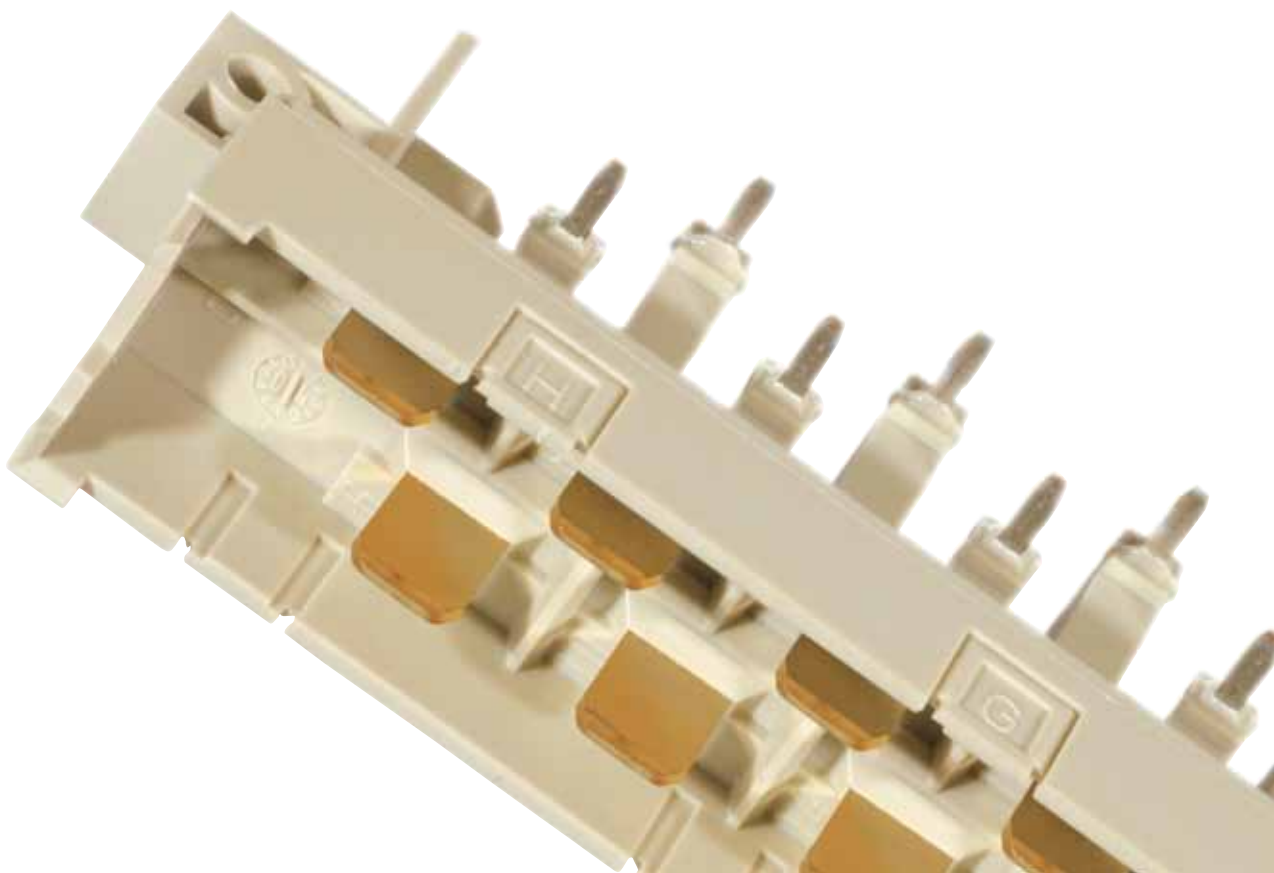

TECHNICAL DATA

Materials		Type B, B/2	Type C, C/2	Type R, R/2	Type D	Type E
Insulator		PBT GF				
Flammability		UL 94 V-0				
Contacts		Copper alloy				
Contact plating		gold over nickel				
Creepage distance	contact-ground contact-contact	≥ 1.2 mm			≥ 3 mm	
Clearance distance	contact-ground contact-contact	≥ 1.2 mm			≥ 3 mm	
Initial contact resistance		≤ 20 mΩ			≤ 15 mΩ	
Initial insulation resistance	Quality class 1 Quality class 2 Quality class 3	≥ 10 ¹² Ω ≥ 10 ¹² Ω ≥ 10 ¹¹ Ω				
Working voltage		250 V depending on insulation coordination (refer to DIN VDE 0110/IEC 664-1)			125 V	
Working current	+ 20 °C + 70 °C + 100 °C	2 A 1 A 0.5 A			5.5 A 4 A 2.5 A	
Working temperature		-55 °C to +125 °C				
Insulation group		A			C	
Test voltage V.r.m.s.	contact-ground contact-contact	1550 V 1000 V			1550 V 1550 V	
Insertion and withdrawal forces max.		16 positions 15 N 96 positions 90 N			16 positions 20 N 32 positions 40 N	16 positions 20 N 32 positions 40 N 48 positions 60 N
Quality class 3		50 cycles				
Quality class 2		400 cycles				
Quality class 1		500 cycles				

Technical alterations are subjects to change without notice.

TECHNICAL DATA

Materials		Type F	Type G	Type H	Mixed version	
Insulator		PBT GF	PBT GF	PC (Polycarbonat)		
Flammability		UL94 V-0	UL94 V-0	UL94 V-1		
Contacts		Copper alloy				
Contact Plating		gold over nickel		silver	gold over nickel	silver
Creepage distance	contact-ground	≥ 1.6 mm	≥ 1.6 mm (f+z)	≥ 4.5 mm	≥ 1.6 mm	≥ 4.5 mm
	contact-contact					
Clearance distance	contact-ground	≥ 3 mm	≥ 3 mm	≥ 8 mm	≥ 3 mm	≥ 8 mm
	contact-contact		≥ 1.9 mm (f+z)			
Initial contact resistance		≤ 15 mΩ				≤ 8 mΩ
Initial insulation resistance	Quality class 1	≥ 10 ¹² Ω				
	Quality class 2	≥ 10 ¹² Ω				
	Quality class 3	≥ 10 ¹¹ Ω				
Working voltage		125 V	500 V	125 V	500 V	
depending on insulation coordination (refer to DIN VDE 0110 / IEC 664-1)						
Working current	+ 20 °C	5.5 A	15 A	5.5 A	15 A	
	+ 70 °C	4 A	12 A	4 A	12 A	
	+ 100 °C	2.5 A	8 A	2.5 A	8 A	
Working temperature		-55 °C to +125 °C				
Insulation group		C				
Test voltage V.r.m.s.	contact-ground	2550 V	2500 V	3100 V	1550 V	3100 V
	contact-contact	1550 V	1550 V	3100 V	1550 V	3100 V
Insertion and withdrawal forces max.		32 positions 50 N 48 positions 75 N	64 positions 100 N	11 positions 80 N 15 positions 90 N	16+7 positions 67 N 24+7 positions 79 N 36+7 positions 96 N	
Quality class 3		50 cycles				
Quality class 2		400 cycles		500 cycles		
Quality class 1		500 cycles				

Technical alterations are subjects to change without notice.

DERATING DIAGRAMS

Types B, C, R

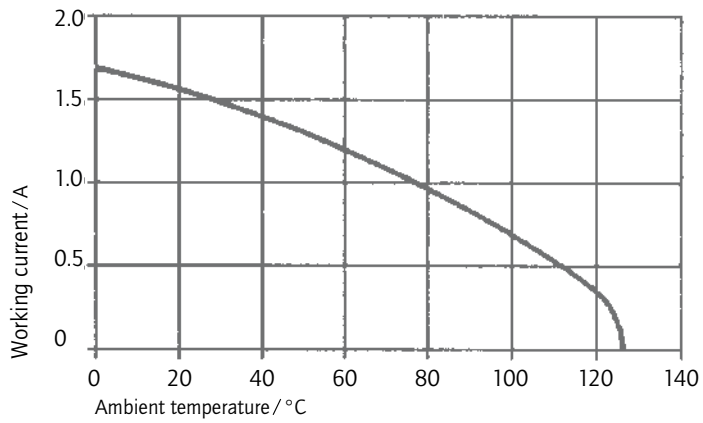

Types D, E, F, G

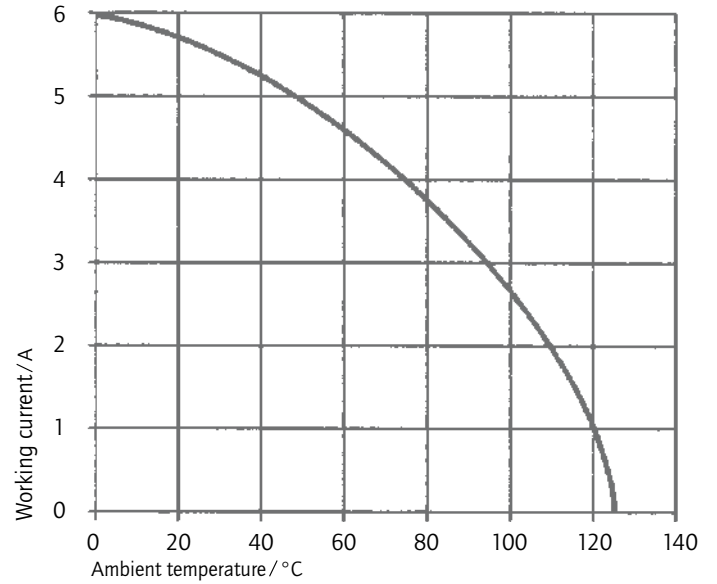

Type H 15

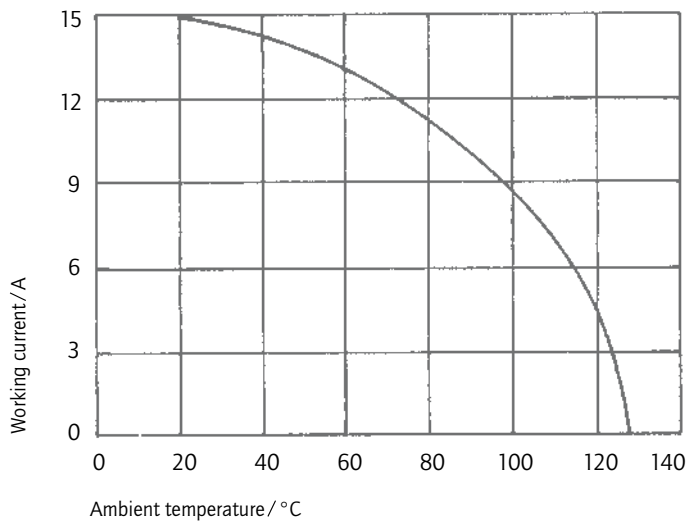

Type H 11

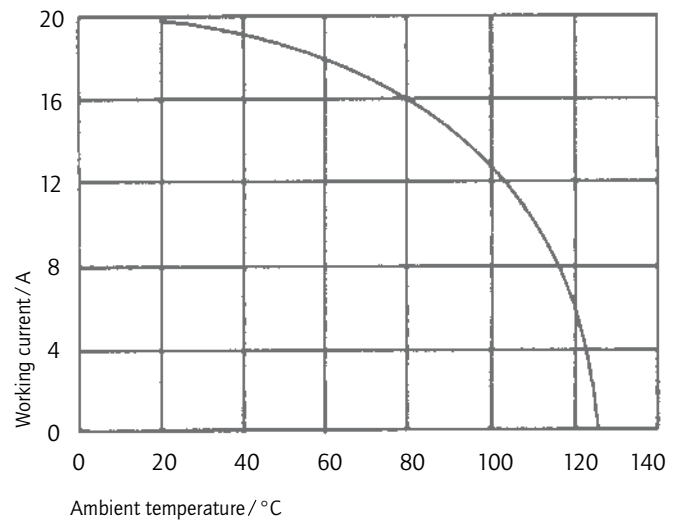

CONVERSION TABLE

μm 1/1000 mm	μinch 1/1000 inch	mm	inch	mm	inch	mm	inch	mm	inch	mm	inch
0,10	4	3,30	.130	10,16	.400	19,50	.768	30,90	1.217	49,50	1.949
0,20	8	3,40	.134	10,26	.402	19,70	.776	31,00	1.220	49,90	1.965
0,25	10	3,50	.138	10,36	.406	19,80	.780	31,20	1.228	50,10	1.972
0,30	12	3,60	.142	10,56	.413	19,90	.783	31,50	1.240	50,30	1.980
0,50	20	3,70	.146	10,66	.417	20,00	.787	31,70	1.248	50,50	1.988
0,70	28	3,80	.150	10,76	.421	20,10	.791	32,00	1.260	50,70	1.996
0,75	30	3,81	.150	11,00	.433	20,30	.799	32,20	1.268	50,80	2.000
0,80	32	3,90	.154	11,20	.441	20,32	.800	32,30	1.272	51,40	2.024
1,00	39	4,00	.158	11,40	.449	20,50	.807	32,50	1.280	51,50	2.028
1,27	50	4,10	.161	11,50	.453	21,00	.827	32,80	1.291	52,00	2.047
2,00	79	4,20	.165	11,60	.457	21,10	.831	33,00	1.299	52,30	2.059
2,50	98	4,30	.169	11,90	.469	21,70	.854	33,10	1.303	52,80	2.079
3,00	118	4,50	.177	12,00	.472	22,00	.866	33,30	1.311	53,00	2.087
4,00	157	4,70	.185	12,20	.480	22,10	.870	33,80	1.331	53,20	2.095
5,00	197	4,90	.193	12,30	.484	22,20	.874	34,00	1.339	53,80	2.118
		5,00	.197	12,40	.488	22,30	.878	34,20	1.346	54,00	2.126
		5,08	.200	12,50	.492	22,40	.882	34,40	1.354	54,20	2.134
0,10	.004	5,10	.201	12,70	.500	22,50	.886	35,00	1.378	54,90	2.161
0,20	.008	5,20	.205	12,90	.508	22,60	.890	35,40	1.394	55,00	2.165
0,25	.012	5,30	.209	13,00	.512	22,80	.898	35,50	1.398	55,40	2.181
0,35	.014	5,40	.213	13,10	.516	22,86	.900	35,56	1.400	55,70	2.193
0,40	.016	5,40	.213	13,20	.520	22,90	.902	35,60	1.402	56,60	2.228
0,45	.018	5,50	.217	13,50	.532	23,00	.906	36,00	1.417	57,40	2.260
0,50	.020	5,60	.220	13,60	.535	23,10	.909	36,50	1.437	57,80	2.276
0,55	.022	5,70	.224	13,70	.539	23,30	.917	36,60	1.441	57,90	2.280
0,60	.024	5,80	.228	13,90	.547	23,50	.925	36,70	1.445	58,42	2.300
0,64	.025	6,00	.236	14,00	.551	24,00	.945	37,00	1.457	59,00	2.323
0,65	.026	6,10	.240	14,30	.563	24,30	.957	37,30	1.469	59,20	2.331
0,70	.028	6,40	.252	14,40	.567	24,60	.969	37,50	1.476	59,80	2.354
0,75	.030	6,50	.256	14,50	.571	24,90	.980	37,60	1.480	59,90	2.358
0,80	.032	6,60	.260	14,70	.579	25,00	.984	37,70	1.484	60,00	2.362
0,85	.034	6,70	.264	14,80	.583	25,10	.998	37,90	1.492	60,96	2.400
0,90	.035	6,80	.268	14,90	.587	25,40	1.000	38,00	1.496	61,10	2.406
1,00	.039	6,90	.272	14,98	.590	25,60	1.008	38,10	1.500	62,00	2.441
1,20	.047	7,00	.276	15,00	.591	25,90	1.020	39,00	1.535	63,00	2.480
1,25	.049	7,10	.280	15,20	.598	26,00	1.024	39,20	1.543	63,50	2.500
1,27	.050	7,20	.283	15,24	.600	26,30	1.035	39,30	1.547	64,00	2.520
1,30	.051	7,40	.291	15,40	.606	26,60	1.047	39,90	1.571	65,00	2.560
1,35	.053	7,50	.295	15,50	.610	26,70	1.051	40,00	1.575	67,00	2.638
1,40	.055	7,60	.299	15,60	.614	27,00	1.063	40,30	1.587	68,00	2.677
1,45	.057	7,62	.300	15,90	.626	27,20	1.071	40,40	1.591	69,00	2.717
1,50	.059	7,70	.303	16,00	.630	27,40	1.079	40,60	1.598	70,00	2.756
1,60	.063	7,80	.307	16,20	.638	27,50	1.093	41,00	1.614	71,00	2.795
1,70	.067	7,98	.314	16,50	.650	27,90	1.098	41,60	1.638	74,00	2.913
1,80	.071	8,00	.315	16,60	.654	27,94	1.100	42,70	1.681	75,00	2.953
1,85	.073	8,18	.318	16,80	.661	28,00	1.102	43,18	1.700	76,20	3.000
1,90	.075	8,20	.323	17,00	.669	28,20	1.110	44,20	1.740	77,00	3.032
2,00	.079	8,30	.327	17,20	.677	28,50	1.122	44,80	1.764	78,74	3.100
2,10	.083	8,40	.331	17,30	.681	28,70	1.130	45,80	1.803	80,00	3.150
2,20	.087	8,50	.335	17,50	.689	29,00	1.142	46,30	1.823	81,28	3.200
2,30	.091	8,60	.339	17,60	.693	29,20	1.150	46,70	1.839	84,00	3.307
2,40	.095	8,90	.350	17,70	.697	29,40	1.158	47,00	1.850	85,00	3.346
2,50	.098	9,00	.354	17,78	.700	29,50	1.161	47,20	1.858	86,36	3.400
2,54	.100	9,10	.358	17,80	.701	29,70	1.169	47,30	1.862	88,90	3.500
2,60	.102	9,20	.362	17,90	.705	29,90	1.177	47,50	1.870	90,00	3.543
2,70	.106	9,30	.366	18,00	.709	30,00	1.181	47,80	1.882	91,44	3.600
2,80	.110	9,40	.370	18,10	.713	30,20	1.189	48,00	1.890	94,00	3.701
2,84	.112	9,50	.374	18,30	.721	30,40	1.197	48,10	1.894	95,00	3.740
2,90	.114	9,60	.378	18,60	.732	30,48	1.200	48,26	1.900	100,00	3.937
3,00	.118	9,70	.382	19,00	.748	30,50	1.201	48,80	1.921	110,00	4.331
3,10	.122	9,90	.390	19,20	.756	30,80	1.213	49,10	1.933	120,00	4.724
3,20	.126	10,00	.395								

TYPE B

Male connector – straight and angled – 32 and 64 positions

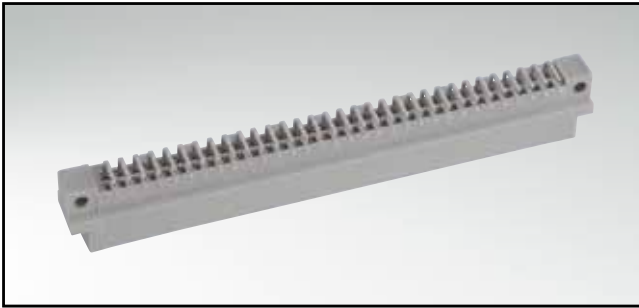

RoHS compliant

DESCRIPTION

- Solder pin
- Quality class 3 (also available in quality class 2 or 1)
- Premating contacts in row "a" und "b" available
- Special assembly on request

PRODUCT DRAWING

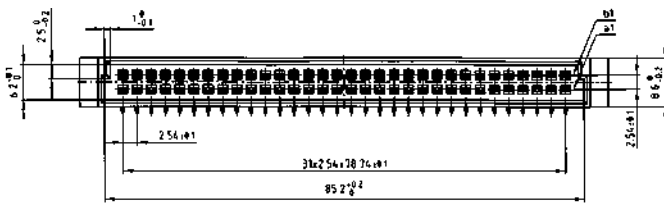

PCB-hole pattern

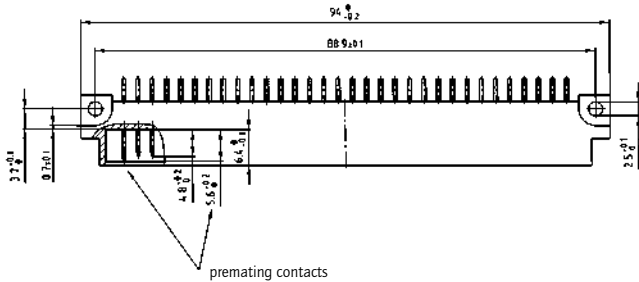
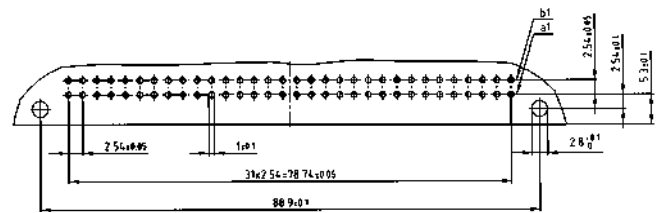

Solder pin angled

Solder pin straight

Solder pin angled with clip

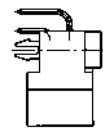
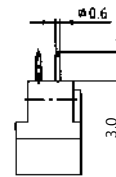
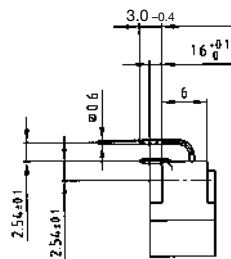

ORDER DATA

(Dim. = mm)

No. of Pos.	Row	• = contact, + = no contact					Solder pin angled	Solder pin straight	Solder pin angled with clip
		Pos. 1	2	3	4	5 ...			
32	b	+	+	+	+	+	121 A 10019 X	121 A 10049 X	121 A 20819 X
	a	•	•	•	•	•			
32	b	+	•	+	•	+	121 A 10029 X	121 A 10059 X	121 A 20829 X
	a	+	•	+	•	+			
64	b	•	•	•	•	•	121 A 10039 X	121 A 10069 X	121 A 20839 X
	a	•	•	•	•	•			

Clip for hole diameter 2.8 ± 0.1 mm, PCB thickness = 1.6 mm

TYPE B

Female connector – straight and angled – 32 and 64 positions

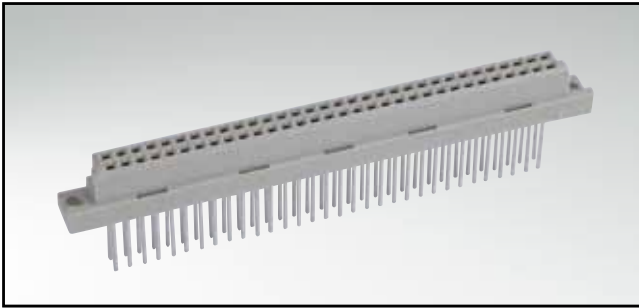

RoHS compliant

DESCRIPTION

- Solder pin, solder lug and wire wrap
- Quality class 3 (also available in quality class 2 or 1)
- Special assembly on request

PRODUCT DRAWING

PCB-hole pattern

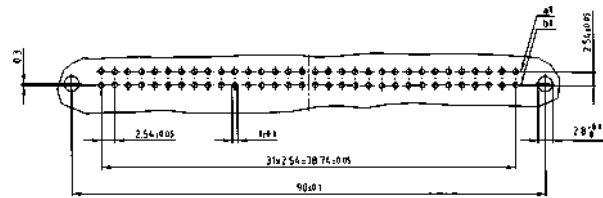
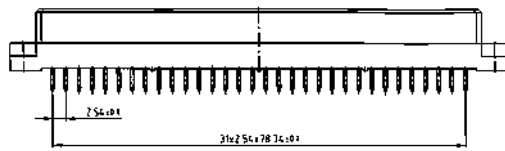

Panel cutout

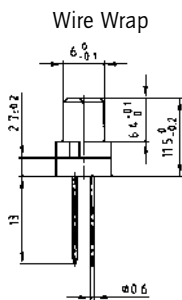
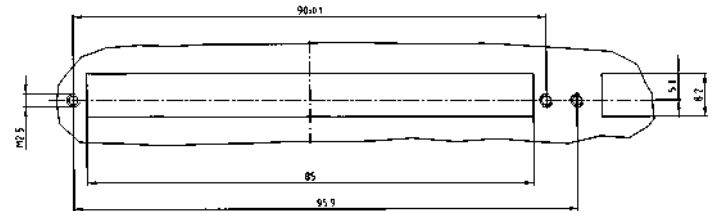
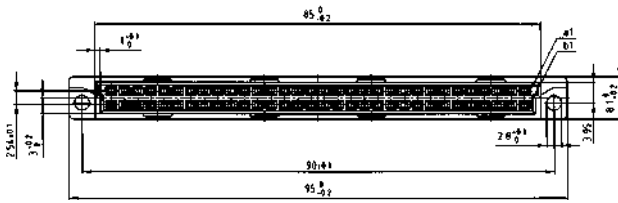

Wire Wrap

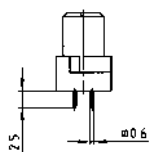

Solder pin straight 2.5 mm

Solder pin straight 4 mm

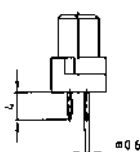

Solder lug

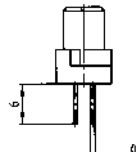

Solder pin angled

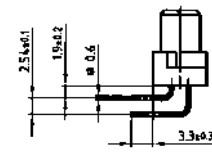

Solder pin straight 2.5 mm with clip

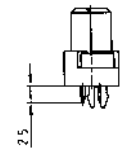

ORDER DATA

(Dim. = mm)

No. of Pos.	Row	• = contact, + = no contact					Wire Wrap	Solder pin straight 2.5 mm	Solder pin straight 4 mm	Solder lug	Solder pin angled	Solder pin straight 2.5 mm with clip	
		Pos.. 1	2	3	4	5							...
32	a	•	•	•	•	•	122 A 10019 X	122 A 10049 X	122 A 10079 X	122 A 10109 X	122 A 10139 X	122 A 13189 X	
	b	+	+	+	+	+							
32	a	+	•	+	•	+	•	122 A 10029 X	122 A 10059 X	122 A 10089 X	122 A 10119 X	122 A 10149 X	122 A 13199 X
	b	+	•	+	•	+	•						
64	a	•	•	•	•	•	•	122 A 10039 X	122 A 10069 X	122 A 10099 X	122 A 10129 X	122 A 10159 X	122 A 13209 X
	b	•	•	•	•	•	•						

Clip for hole diameter 2.8 + 0.1 mm, PCB thickness = 1.6 mm

TYPE B/2

Male connector – straight and angled – 16 and 32 positions

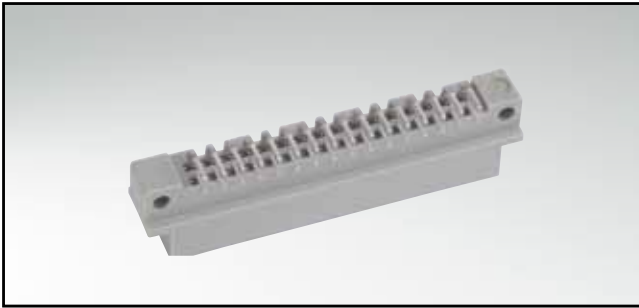

RoHS compliant

DESCRIPTION

- Solder pin
- Quality class 3 (also available in quality class 2 or 1)
- Premating contacts in row "a" und "b" available
- Special assembly on request

PRODUCT DRAWING

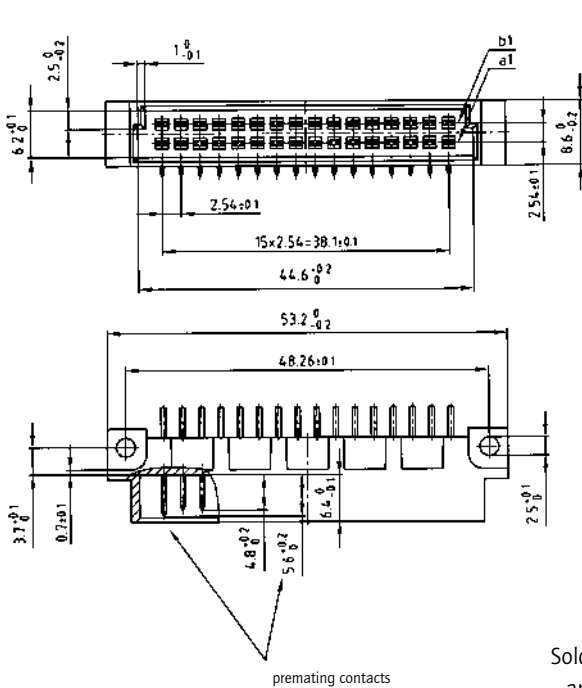

PCB-hole pattern

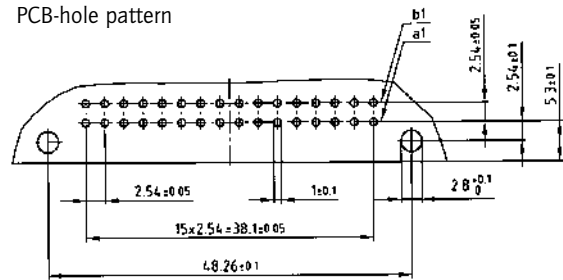

Solder pin angled

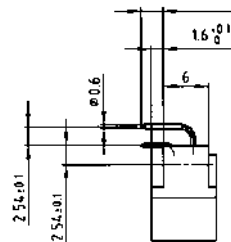

Solder pin straight

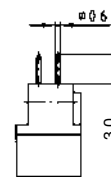

Solder pin angled with clip

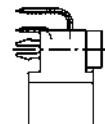

ORDER DATA

(Dim. = mm)

No. of Pos.	Row	• = contact, + = no contact						Solder pin angled	Solder pin straight	Solder pin angled with clip
		Pos. 1	2	3	4	5	...			
16	b	•	•	•	•	•	•	121 A 10259 X	121 A 10289 X	121 A 20849 X
	a	+	+	+	+	+	+			
16	b	+	•	+	•	+	•	121 A 10269 X	121 A 10299 X	121 A 20859 X
	a	+	•	+	•	+	•			
32	b	•	•	•	•	•	•	121 A 10279 X	121 A 10309 X	121 A 20869 X
	a	•	•	•	•	•	•			

Clip for hole diameter 2.8 + 0.1 mm, PCB thickness = 1.6 mm

TYPE B/2

Female connector – straight and angled – 16 and 32 positions

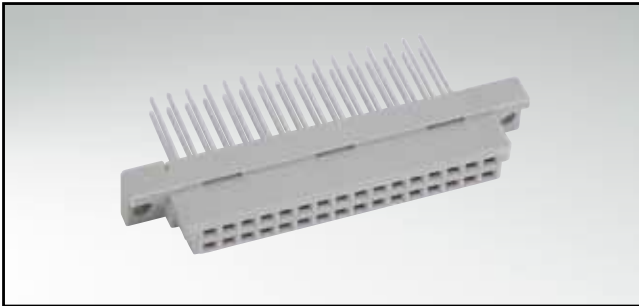

RoHS compliant

DESCRIPTION

- Solder pin, solder lug and wire wrap
- Quality class 3 (also available in quality class 2 or 1)
- Special assembly on request

PRODUCT DRAWING

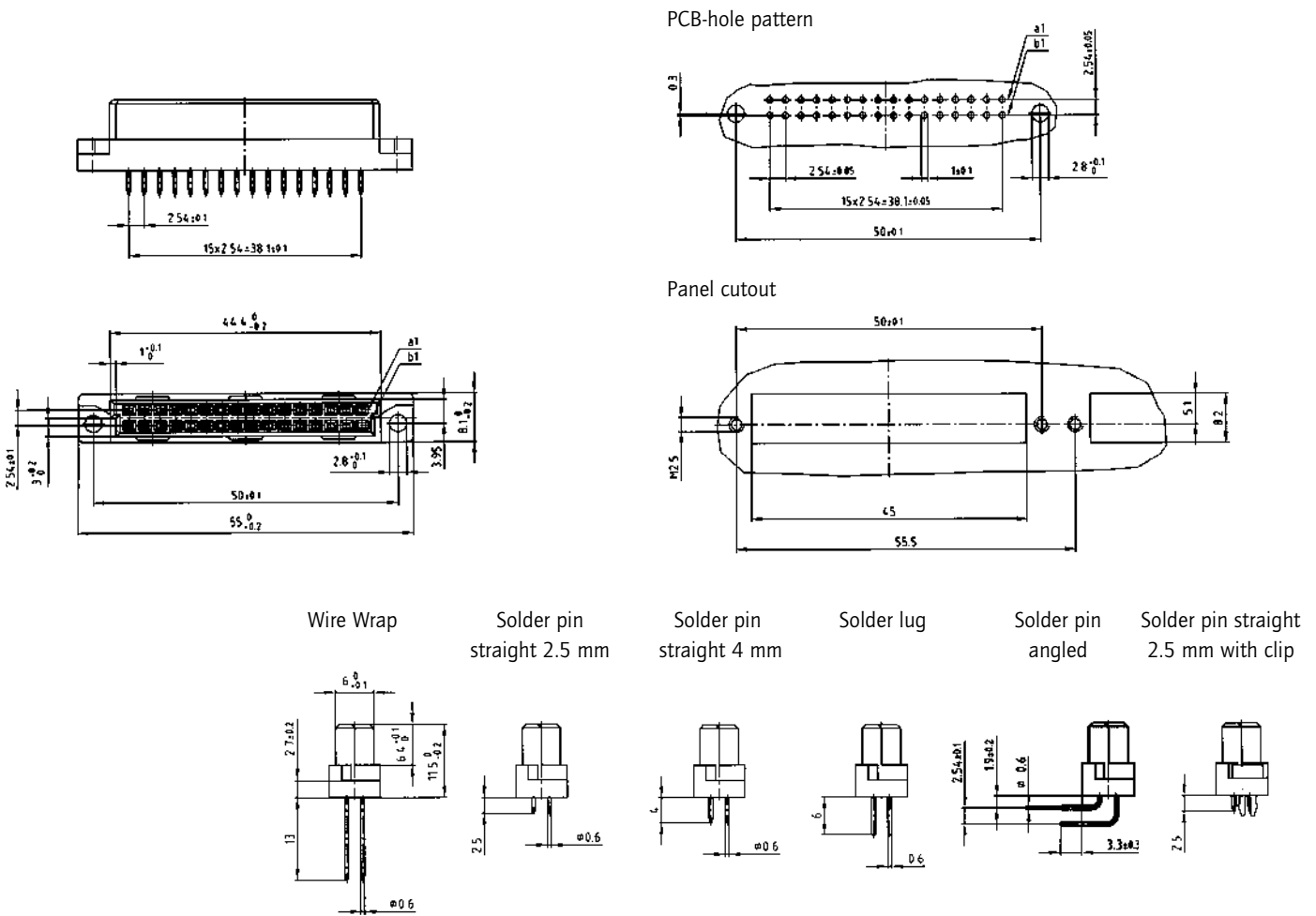

(Dim. = mm)

ORDER DATA

No. of Pos.	Row	• = contact, + = no contact					Wire Wrap	Solder pin straight 2.5 mm	Solder pin straight 4 mm	Solder lug	Solder pin angled	Solder pin straight 2.5 mm with clip
		Pos. 1	2	3	4	5 ...						
16	a	•	•	•	•	•	122 A 10419 X	122 A 10449 X	122 A 10479 X	122 A 10509 X	122 A 10539 X	122 A 13219 X
	b	+	+	+	+	+						
16	a	+	•	+	•	+	122 A 10429 X	122 A 10459 X	122 A 10489 X	122 A 10519 X	122 A 10549 X	122 A 13229 X
	b	+	•	+	•	+						
32	a	•	•	•	•	•	122 A 10439 X	122 A 10469 X	122 A 10499 X	122 A 10529 X	122 A 10559 X	122 A 13239 X
	b	•	•	•	•	•						

Clip for hole diameter 2.8 + 0.1 mm, PCB thickness = 1.6 mm

TYPE C

Male connector – straight and angled – 32, 64 and 96 positions



RoHS compliant

DESCRIPTION

- Solder pin
- Quality class 3 (also available in quality class 2 or 1)
- Premating contacts in row "a", "b" and "c" available
- Special assembly on request

PRODUCT DRAWING

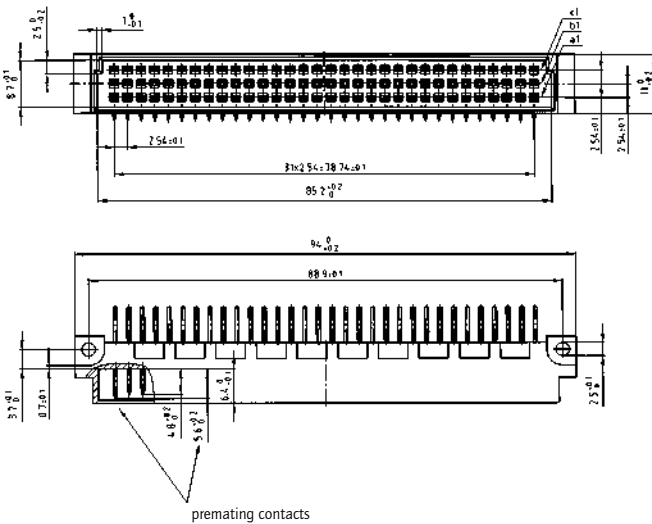

PCB-hole pattern

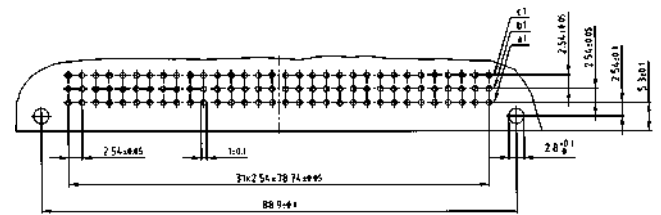

Solder pin angled

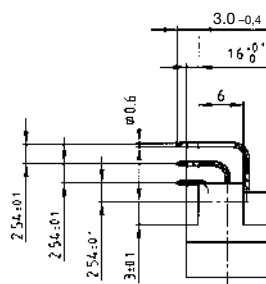

Solder pin straight

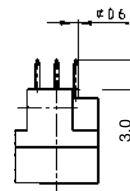

Solder pin angled with clip

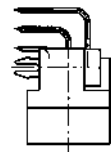

ORDER DATA

(Dim. = mm)

No. of Pos.	Row	• = contact, + = no contact						Solder pin angled	Solder pin straight	Solder pin angled with clip
		Pos.	1	2	3	4	5			
32	c		+	+	+	+	+	121 A 10109 X	121 A 10159 X	121 A 20879 X
	b		+	+	+	+	+			
	a		•	•	•	•	•			
32	c		+	•	+	•	+	121 A 10119 X	121 A 10169 X	121 A 20889 X
	b		+	+	+	+	+			
	a		+	•	+	•	+			
64	c		•	•	•	•	•	121 A 10139 X	121 A 10189 X	121 A 20909 X
	b		+	+	+	+	+			
	a		•	•	•	•	•			
96	c		•	•	•	•	•	121 A 10149 X	121 A 10199 X	121 A 20919 X
	b		•	•	•	•	•			
	a		•	•	•	•	•			

Clip for hole diameter 2.8 ± 0.1 mm, PCB thickness = 1.6 mm

TYPE C

Female connector – straight and angled – 32, 64 and 96 positions

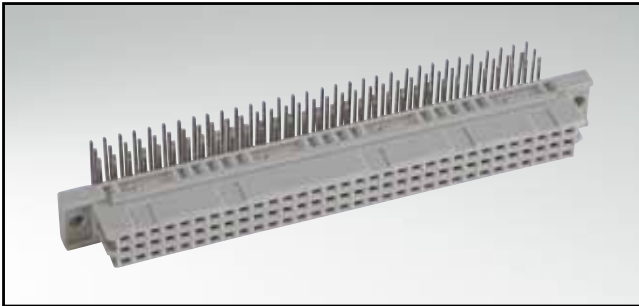

RoHS compliant

DESCRIPTION

- Solder pin, solder lug and wire wrap
- Quality class 3 (also available in quality class 2 or 1)
- Special assembly on request

PRODUCT DRAWING

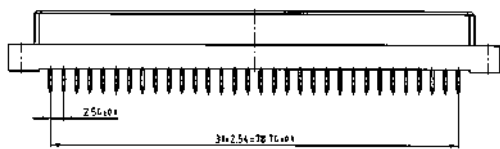

PCB-hole pattern

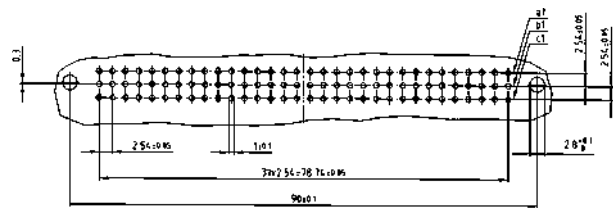

Panel cutout

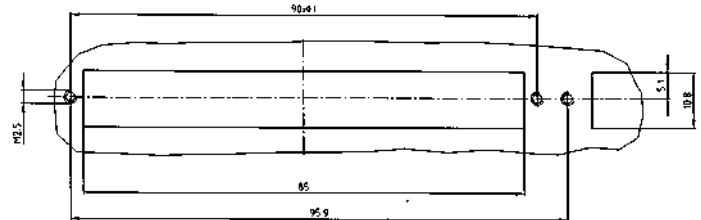
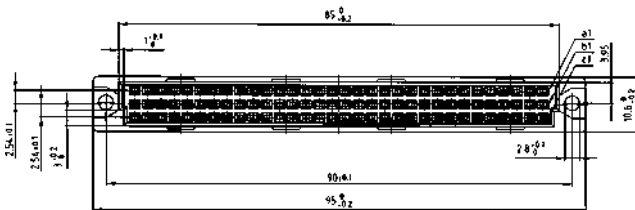

Wire Wrap

Solder pin straight 2.5 mm

Solder pin straight 4 mm

Solder lug

Solder pin angled

Solder pin straight 2.5 mm with clip

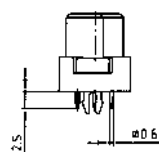
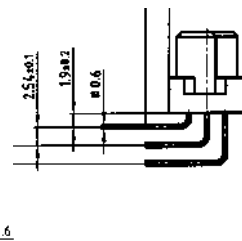
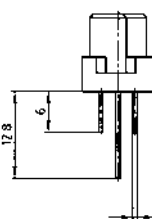
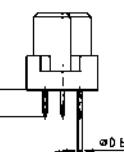
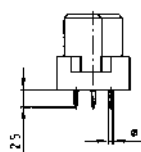
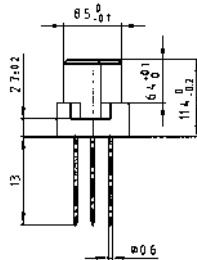

ORDER DATA

(Dim. = mm)

No. of Pos.	Row	• = contact, + = no contact					Wire Wrap	Solder pin straight 2.5 mm	Solder pin straight 4 mm	Solder lug	Solder pin angled	Solder pin straight 2,5 mm with clip
		Pos.	1	2	3	4						
32	a		•	•	•	•						
	b	+	+	+	+	+	122 A 10169 X	122 A 10219 X	122 A 10269 X	122 A 10319 X	122 A 10369 X	122 A 13249 X
	c	+	+	+	+	+						
32	a		•	•	•	•						
	b	+	+	+	+	+	122 A 10179 X	122 A 10229 X	122 A 10279 X	122 A 10329 X	122 A 10379 X	122 A 13259 X
	c	+	•	•	•	•						
64	a		•	•	•	•						
	b	+	+	+	+	+	122 A 10199 X	122 A 10249 X	122 A 10299 X	122 A 10349 X	122 A 10399 X	122 A 13279 X
	c		•	•	•	•						
96	a		•	•	•	•						
	b		•	•	•	•	122 A 10209 X	122 A 10259 X	122 A 10309 X	122 A 10359 X	122 A 10409 X	122 A 13289 X
	c		•	•	•	•						

Clip for hole diameter 2.8 + 0.1 mm, PCB thickness = 1.6 mm

TYPE C/2

Male connector – straight and angled – 16, 32 and 48 positions

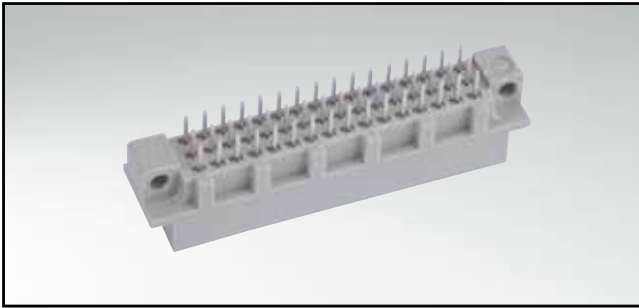

RoHS compliant

DESCRIPTION

- Solder pin
- Quality class 3 (also available in quality class 2 or 1)
- Premating contacts in row "a", "b" and "c" available
- Special assembly on request

PRODUCT DRAWING

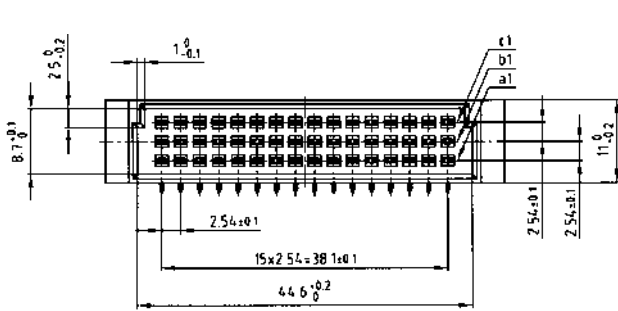

PCB-hole pattern

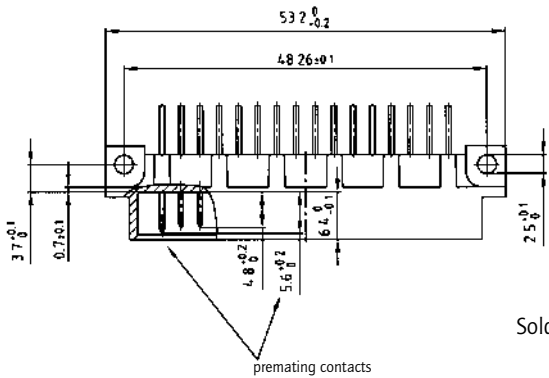
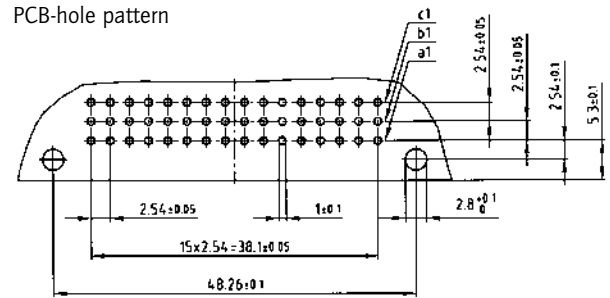

Solder pin angled

Solder pin straight

Solder pin angled with clip

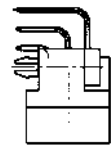
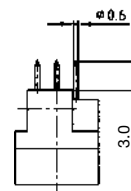
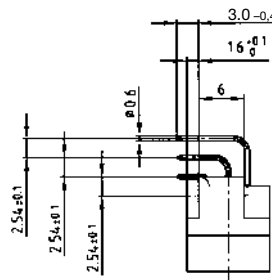

(Dim. = mm)

ORDER DATA

No. of Pos.	Row	• = contact, + = no contact						Solder pin angled	Solder pin straight	Solder pin angled with clip
		Pos.	1	2	3	4	5			
16	c		+	+	+	+	+	121 A 10349 X	121 A 10399 X	121 A 20929 X
	b		+	+	+	+	+			
	a		•	•	•	•	•			
16	c		+	•	•	•	•	121 A 10359 X	121 A 10409 X	121 A 20939 X
	b		+	+	+	+	+			
	a		+	•	•	•	•			
32	c		•	•	•	•	•	121 A 10379 X	121 A 10429 X	121 A 20959 X
	b		+	+	+	+	+			
	a		•	•	•	•	•			
48	c		•	•	•	•	•	121 A 10389 X	121 A 10439 X	121 A 20969 X
	b		•	•	•	•	•			
	a		•	•	•	•	•			

Clip for hole diameter 2.8 ± 0.1 mm, PCB thickness = 1.6 mm

TYPE C/2

Female connector – straight and angled – 16, 32 and 48 positions

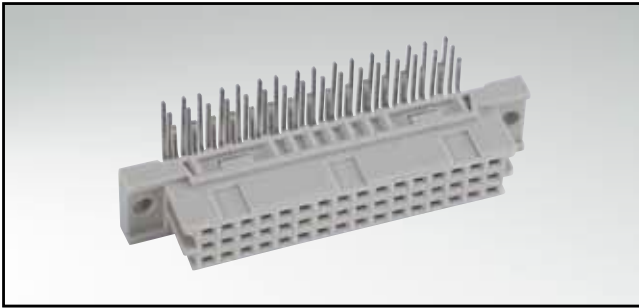

RoHS compliant

DESCRIPTION

- Solder pin, solder lug and wire wrap
- Quality class 3 (also available in quality class 2 or 1)
- Special assembly on request

PRODUCT DRAWING

PCB-hole pattern

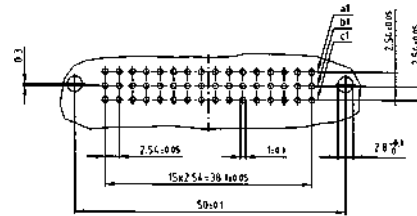
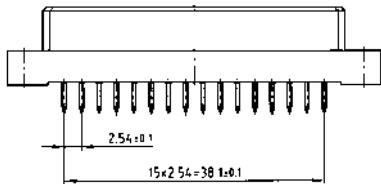

Panel cutout

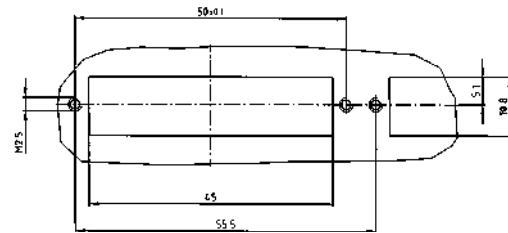
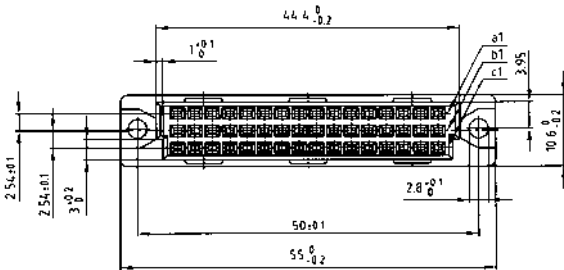

Wire Wrap

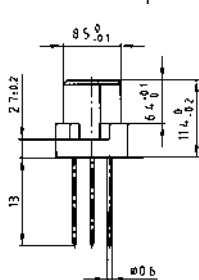

Solder pin straight 2.5 mm

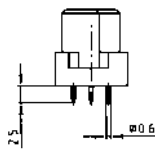

Solder pin straight 4 mm

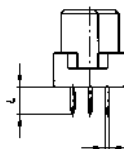

Solder lug

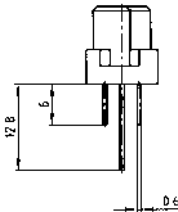

Solder pin angled

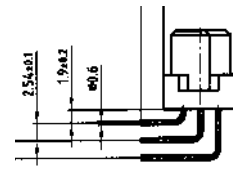

Solder pin straight 2.5 mm with clip

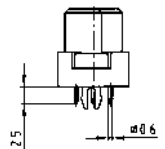

ORDER DATA

(Dim. = mm)

No. of Pos.	Row	• = contact, + = no contact					Wire Wrap	Solder pin straight 2.5 mm	Solder pin straight 4 mm	Solder lug	Solder pin angled	Solder pin straight 2,5 mm with clip
		Pos.	1	2	3	4						
16	a		•	•	•	•						
	b	+	+	+	+	+	122 A 10579 X	122 A 10629 X	122 A 10679 X	122 A 10729 X	122 A 10779 X	122 A 13299 X
	c	+	+	+	+	+						
16	a		•	•	•	•						
	b	+	+	+	+	+	122 A 10589 X	122 A 10639 X	122 A 10689 X	122 A 10739 X	122 A 10789 X	122 A 13309 X
	c	+	•	•	•	•						
32	a		•	•	•	•						
	b	+	+	+	+	+	122 A 10609 X	122 A 10659 X	122 A 10709 X	122 A 10759 X	122 A 10809 X	122 A 13329 X
	c		•	•	•	•						
48	a		•	•	•	•						
	b		•	•	•	•	122 A 10619 X	122 A 10669 X	122 A 10719 X	122 A 10769 X	122 A 10819 X	122 A 13339 X
	c		•	•	•	•						

Clip for hole diameter 2.8 ± 0.1 mm, PCB thickness = 1.6 mm

TYPE R

Male connector – straight – 32, 64 and 96 positions

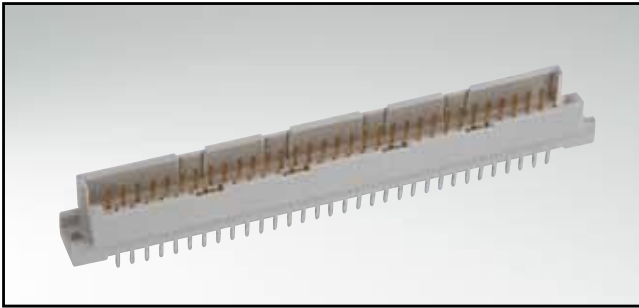

RoHS compliant

DESCRIPTION

- Solder pin and wire wrap
- Quality class 3 (also available in quality class 2 or 1)

PRODUCT DRAWING

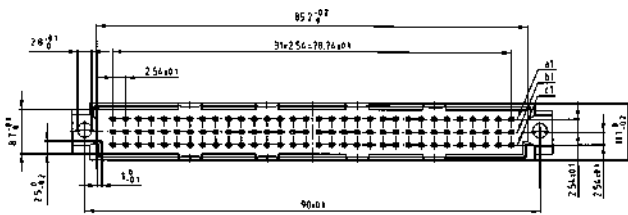

PCB-hole pattern

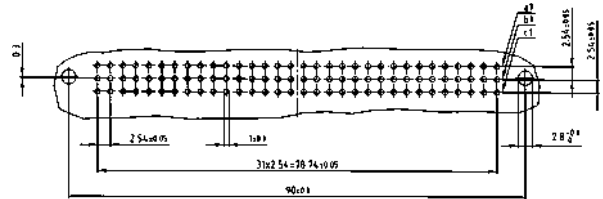

Panel cutout

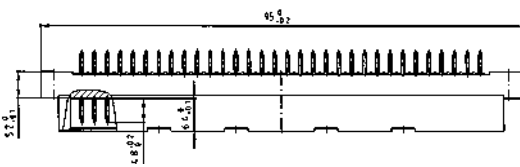
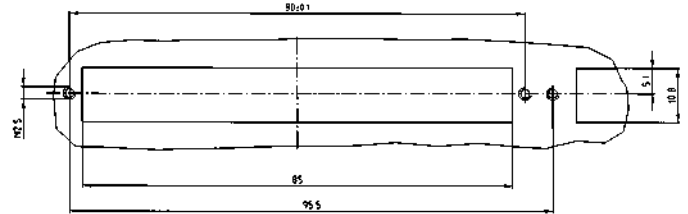

Wire Wrap

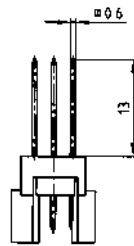

Solder pin straight

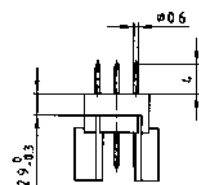

ORDER DATA

(Dim. = mm)

No. of Pos.	Row	• = contact, + = no contact					Wire Wrap	Solder pin straight		
		Pos.	1	2	3	4			5	...
32	a		+	•	+	•	+	•	121 A 10509 X	121 A 10549 X
	b		+	+	+	+	+	+		
	c		+	•	+	•	+	•		
64	a		•	•	•	•	•	•	121 A 10519 X	121 A 10559 X
	b		+	+	+	+	+	+		
	c		•	•	•	•	•	•		
96	a		•	•	•	•	•	•	121 A 10529 X	121 A 10569 X
	b		•	•	•	•	•	•		
	c		•	•	•	•	•	•		

TYPE R

Female connector – angled – 32, 64 and 96 positions

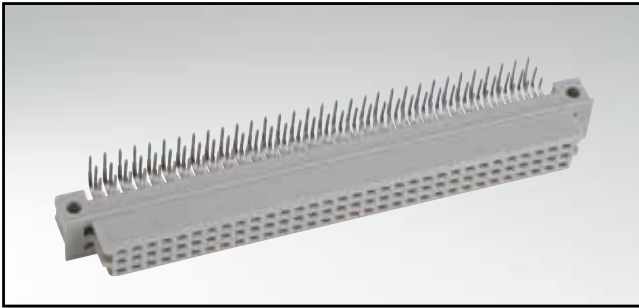

RoHS compliant

DESCRIPTION

- Solder pin
- Quality class 3 (also available in quality class 2 or 1)

PRODUCT DRAWING

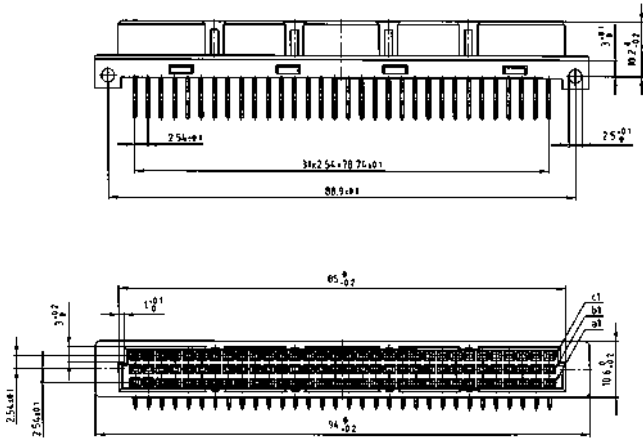

PCB-hole pattern

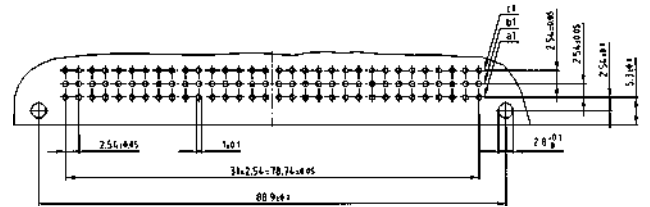

Solder pin angled

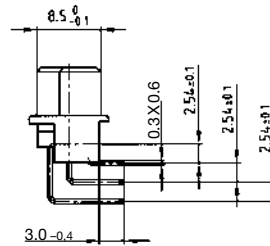

ORDER DATA

(Dim. = mm)

No. of Pos.	Row	• = contact, + = no contact						Solder pin angled
		Pos. 1	2	3	4	5	...	
32	c	+	•	+	•	+	•	122 A 10839X
	b	+	+	+	+	+	+	
	a	+	•	+	•	+	•	
64	c	•	•	•	•	•	•	122 A 10849X
	b	+	+	+	+	+	+	
	a	•	•	•	•	•	•	
96	c	•	•	•	•	•	•	122 A 10859X
	b	•	•	•	•	•	•	
	a	•	•	•	•	•	•	

TYPE R/2

Male connector – straight – 32 and 48 positions

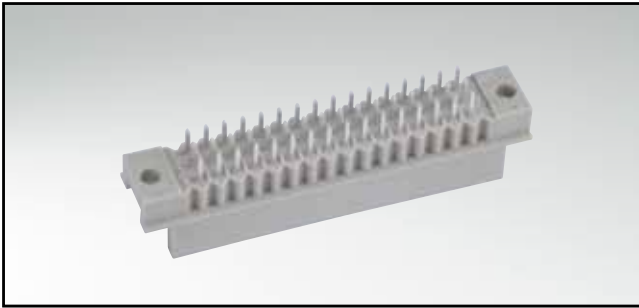

RoHS compliant

DESCRIPTION

- Solder pin and wire wrap
- Quality class 3 (also available in quality class 2 or 1)

PRODUCT DRAWING

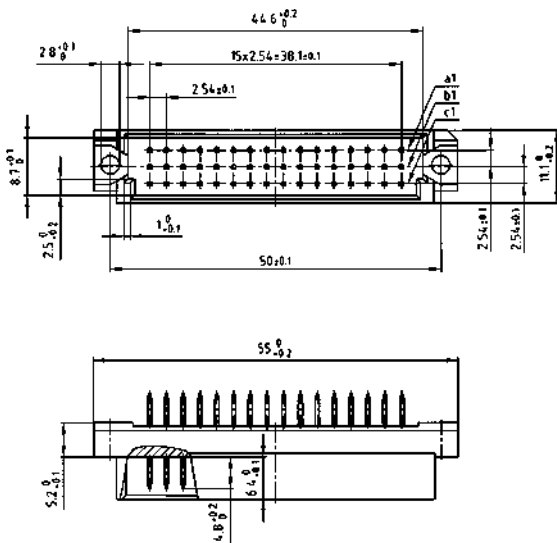

PCB-hole pattern

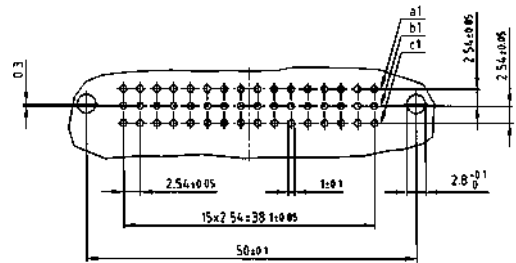

Panel cutout

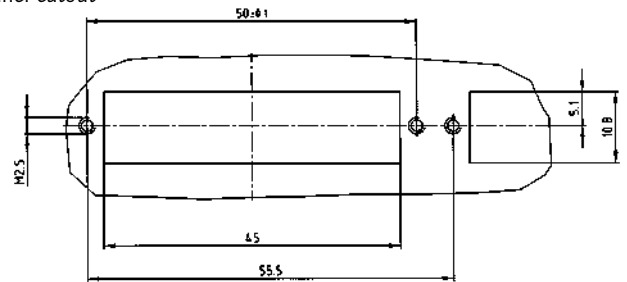

Wire Wrap

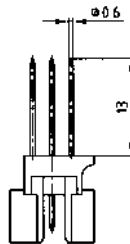

Solder pin straight

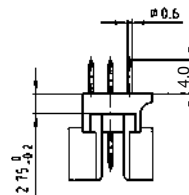

ORDER DATA

(Dim. = mm)

No. of Pos.	Row	• = contact, + = no contact						Wire Wrap	Solder pin straight
		Pos.	1	2	3	4	5		
32	a		•	•	•	•	•	121 A 10589 X	121 A 10619 X
	b	+	+	+	+	+	+		
	c	•	•	•	•	•	•		
48	a		•	•	•	•	•	121 A 10599 X	121 A 10629 X
	b		•	•	•	•	•		
	c		•	•	•	•	•		

TYPE R/2

Female connector – angled – 32 and 48 positions

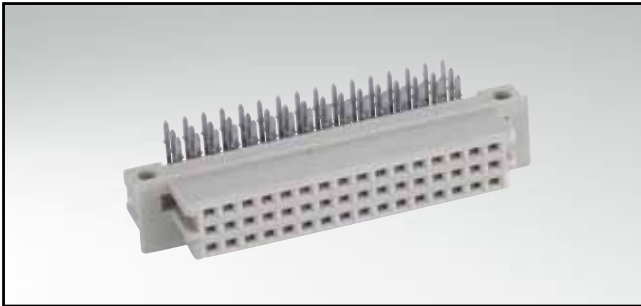

RoHS compliant

DESCRIPTION

- Solder pin
- Quality class 3 (also available in quality class 2 or 1)

PRODUCT DRAWING

PCB-hole pattern

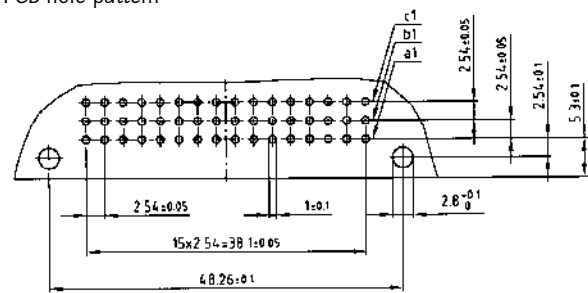
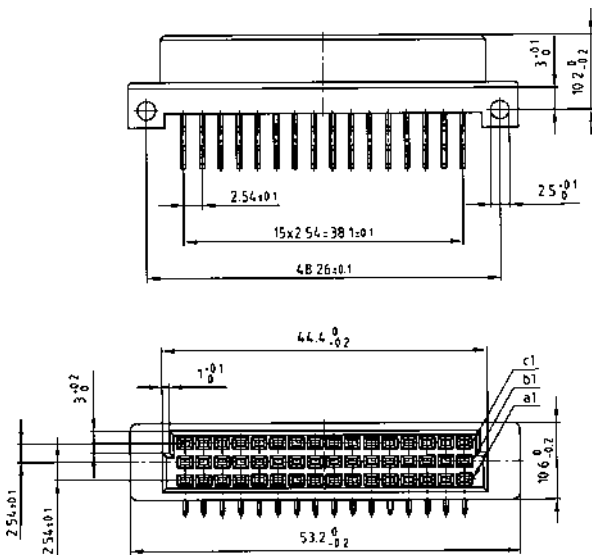

Solder pin angled

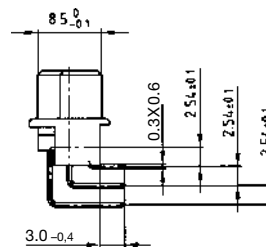

(Dim. = mm)

ORDER DATA

No. of Pos.	Row	• = contact, + = no contact						Solder pin angled
		Pos.	1	2	3	4	5	
32	c		•	•	•	•	•	122 A 10879 X
	b	+	+	+	+	+	+	
	a	•	•	•	•	•	•	
48	c		•	•	•	•	•	122 A 10889 X
	b		•	•	•	•	•	
	a		•	•	•	•	•	

TYPE D

Male connector – straight and angled – 16 and 32 positions

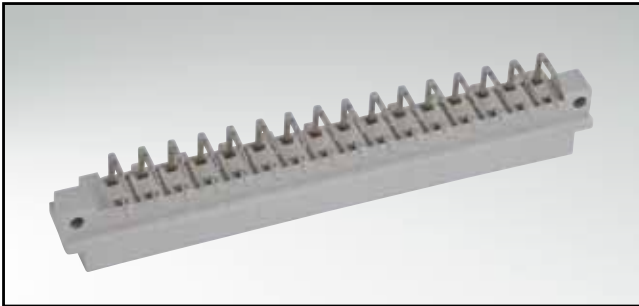

RoHS compliant

DESCRIPTION

- Solder pin
- Quality class 3 (also available in quality class 2 or 1)
- premating contacts in row "a" available
- Special assembly on request

PRODUCT DRAWING

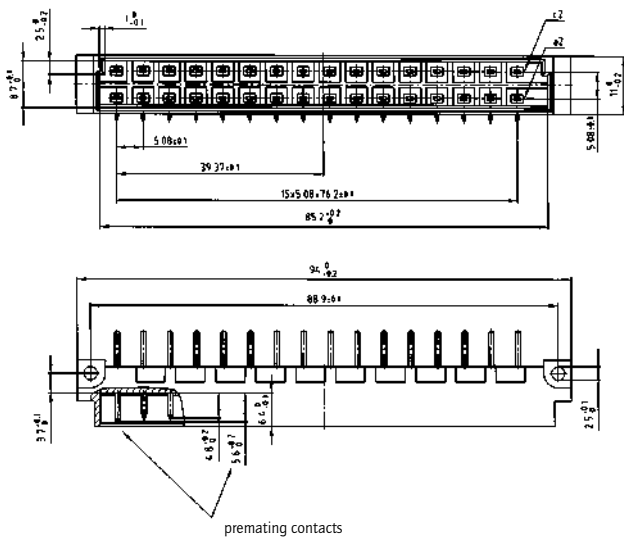

PCB-hole pattern

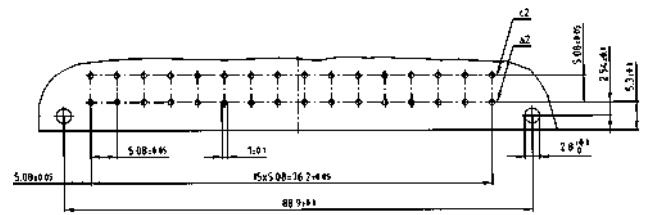

Solder pin angled

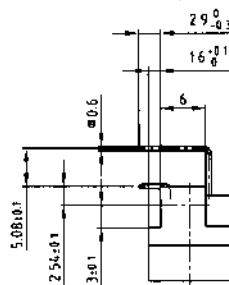

Solder pin straight

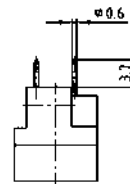

Solder pin angled with clip

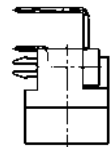

ORDER DATA

(Dim. = mm)

No. of Pos.	Row	• = contact, + = no contact				Solder pin angled	Solder pin straight	Solder pin angled with clip
		Pos.	2	4	6			
16	c		•	+	•	121 A 10639 X	121 A 10659 X	121 A 20979 X
	a		•	+	•			
32	c		•	•	•	121 A 10649 X	121 A 10669 X	121 A 20989 X
	a		•	•	•			

Clip for hole diameter 2.8 + 0.1 mm, PCB thickness = 1.6 mm

TYPE D

Female connector – straight – 16 and 32 positions

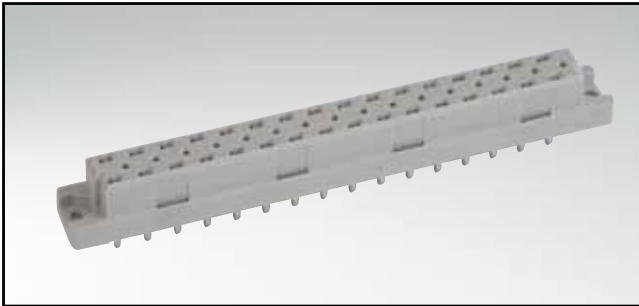

RoHS compliant

DESCRIPTION

- Solder pin, wire wrap and solder lug
- Quality class 3 (also available in quality class 2 or 1)
- Special assembly on request

PRODUCT DRAWING

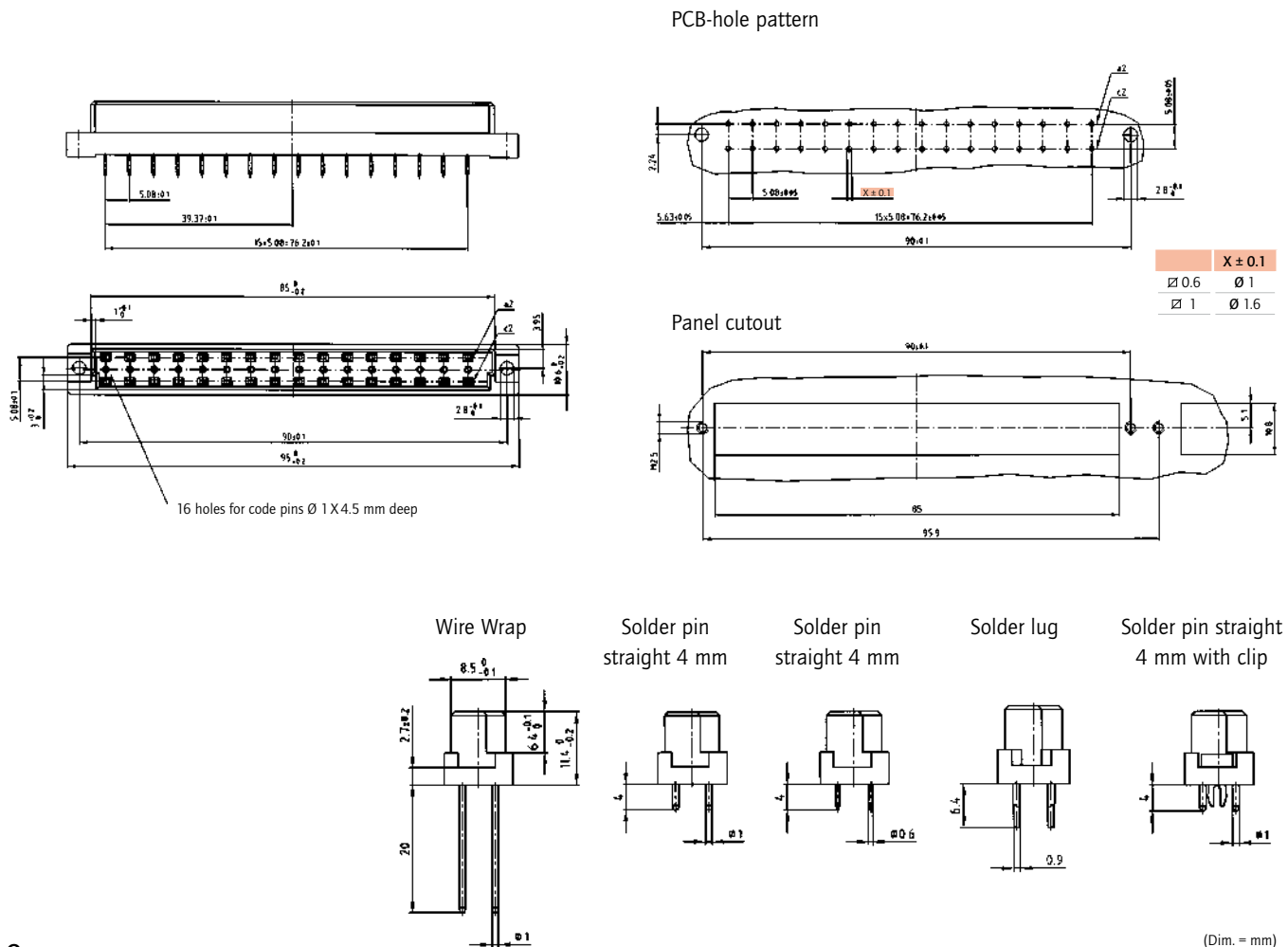

ORDER DATA

No. of Pos.	Row	• = contact, + = no contact				Wire Wrap	Solder pin straight 4.0 mm $\varnothing 1$ mm	Solder pin straight 4.0 mm $\varnothing 0.6$ mm	Solder lug	Solder pin straight 4mm $\varnothing 1$ mm w. clip
		Pos.	2	4	6					
16	a	•	+	•	•	122 A 10919 X	122 A 10939 X	122 A 13079 X	122 A 10959 X	122 A 13349 X
	c	•	+	•	•					
32	a	•	•	•	•	122 A 10929 X	122 A 10949 X	122 A 13089 X	122 A 10969 X	122 A 13359 X
	c	•	•	•	•					

Clip for hole diameter $2.8 + 0.1$ mm, PCB thickness = 1.6 mm

TYPE D WITH SCREW TERMINATION

Female connector – straight – 32 positions

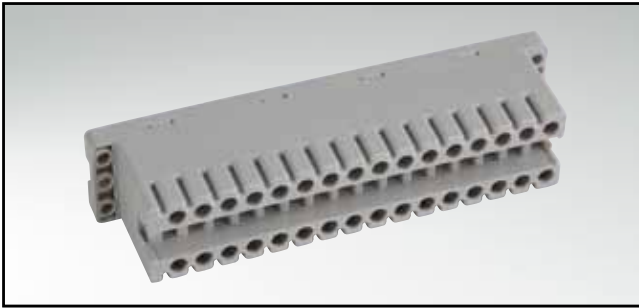

RoHS compliant

TECHNICAL DATA

Conductor size:	AWG 24 to 16
Operating voltage:	6 A
Rated voltage:	300 / 250 V~
Insulator:	PBT GF grey
Operating temperature:	-55°C to +120°C
Flammability:	UL 94 V-0
Material:	Copper alloy
Contact plating:	Quality class 2
Screw connection:	Steel

PRODUCT DRAWING

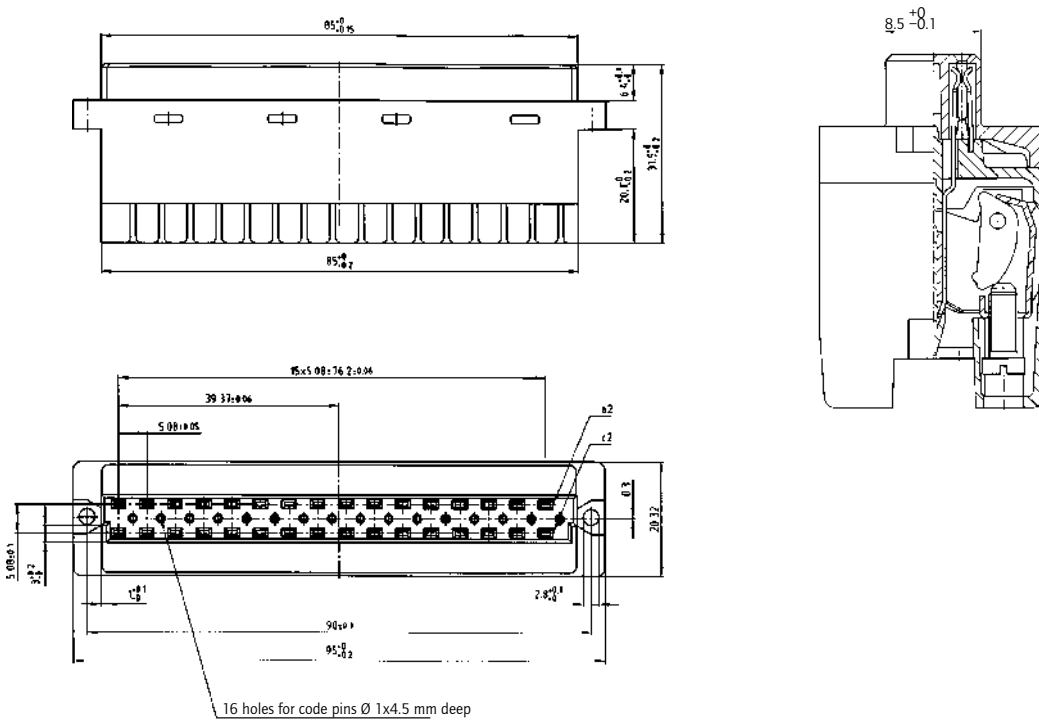

ORDER DATA

(Dim. = mm)

No. of Pos.	Row	Female connector	Latches with strain relief angled	Latches without strain relief straight
32	c a	122 B 13029 X	12-500600	12-500590

TYPE E

Male connector – angled – 32 and 48 positions

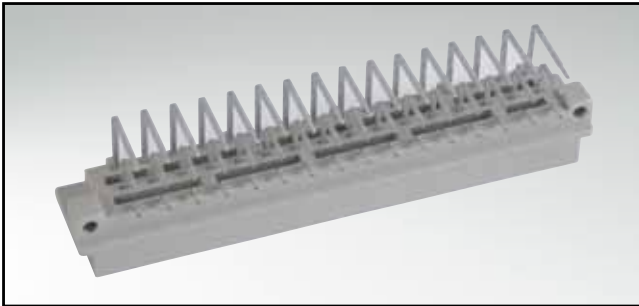

RoHS compliant

DESCRIPTION

- Solder pin
- Quality class 3 (also available in quality class 2 or 1)

PRODUCT DRAWING

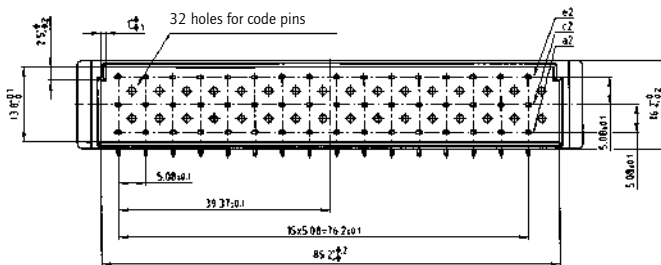

PCB-hole pattern

Solder pin angled 5.08 mm

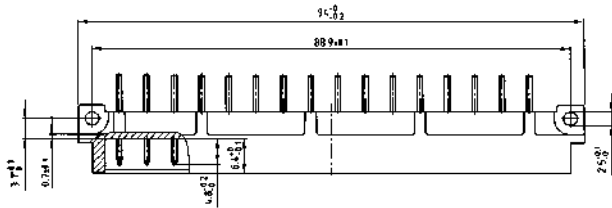
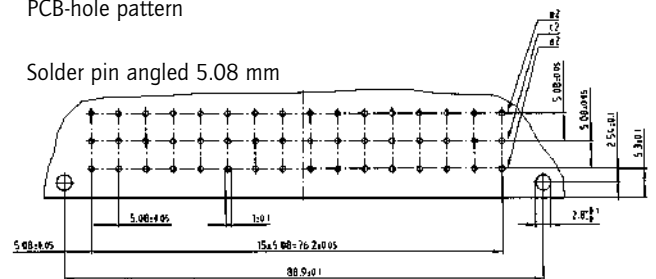

Solder pin angled 2.54 mm

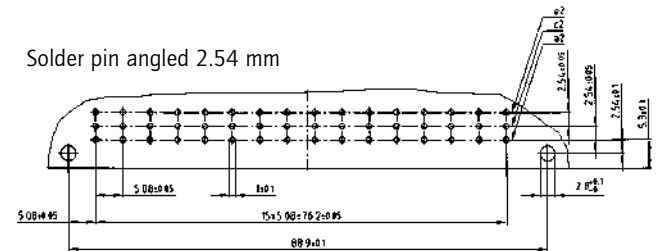

Solder pin angled contact spacing 5.08 mm

Solder pin angled contact spacing 2.54 mm

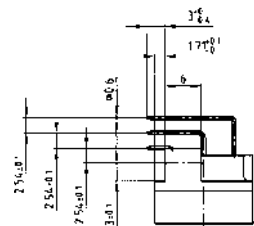
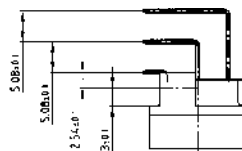

ORDER DATA

(Dim. = mm)

No. of Pos.	Row	• = contact, + = no contact				Solder pin angled contact spacing 5.08 mm	Solder pin angled contact spacing 2.54 mm
		Pos.	2	4	6		
32	e		+	+	+		
	c		•	•	•	121 A 20789 X	121 A 20779 X
	a		•	•	•		
32	e		•	•	•		
	c		+	+	+	121 A 20809 X	121 A 20799 X
	a		•	•	•		
48	e		•	•	•		
	c		•	•	•	121 A 10859 X	121 A 10849 X
	a		•	•	•		

TYPE E

Female connector – straight – 32 and 48 positions

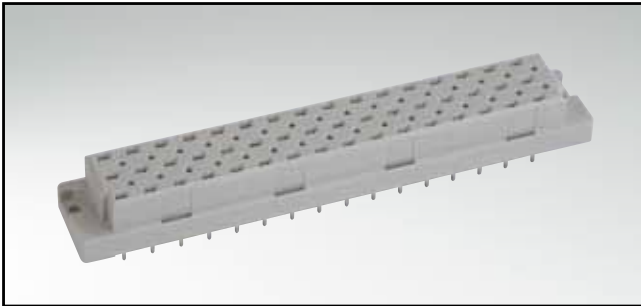

RoHS compliant

DESCRIPTION

- Solder pin, wire wrap and solder lug
- Quality class 3 (also available in quality class 2 or 1)
- Special assembly on request

PRODUCT DRAWING

PCB-hole pattern

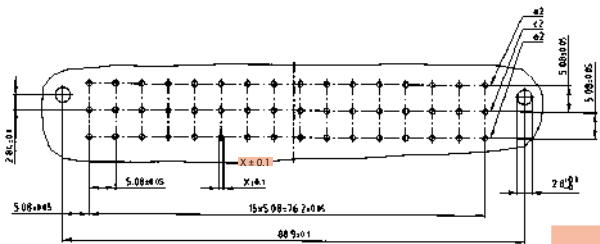
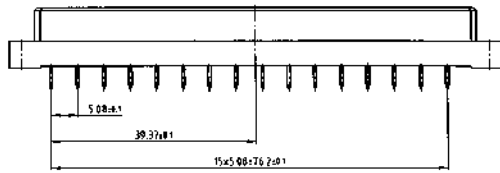

Panel cutout

	$X \pm 0,1$
$\varnothing 0,6$	$\varnothing 1$
$\varnothing 1$	$\varnothing 1,6$

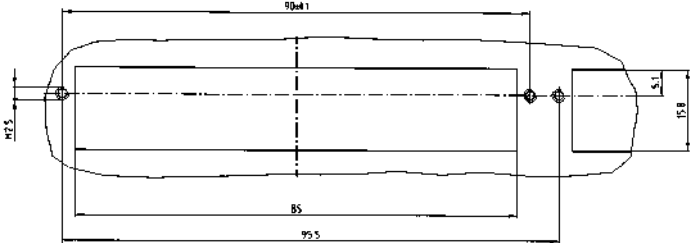
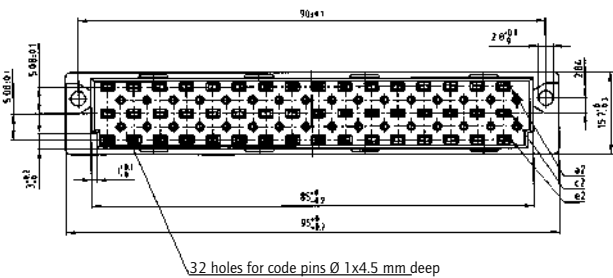

Solder pin straight 4.6 mm

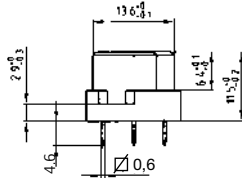

Solder pin straight 4 mm

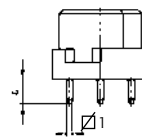

Solder lug

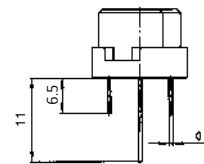

Wire Wrap

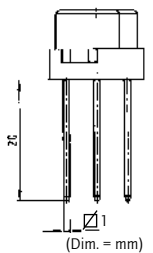

ORDER DATA

No. of Pos.	Row	• = contact, + = no contact				Solder pin straight 4.6 mm $\varnothing 0.6$ mm	Solder pin straight 4.0 mm $\varnothing 1$ mm	Solder lug	Wire Wrap	
		Pos.	2	4	6					...
32	a		•	•	•	•	122 A 13099 X	122 A 13129 X	122 A 13149 X	122 A 13169 X
	c		•	•	•	•				
	e		+	+	+	+				
32	a		•	•	•	•	122 A 13109 X	122 A 13139 X	122 A 13159 X	122 A 13179 X
	c		+	+	+	+				
	e		•	•	•	•				
48	a		•	•	•	•	122 A 13119 X	122 A 11619 X	122 A 11629 X	122 A 11609 X
	c		•	•	•	•				
	e		•	•	•	•				

TYPE F

Male connector – straight and angled – 32 and 48 positions

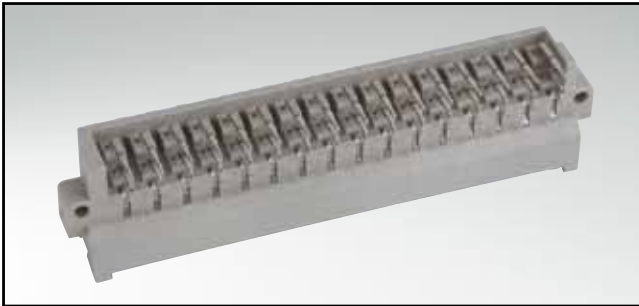

RoHS compliant

DESCRIPTION

- Solder pin
- Quality class 3 (also available in quality class 2 or 1)
- Premating contacts in row "z", "b" and "d" available
- Special assembly on request

PRODUCT DRAWING

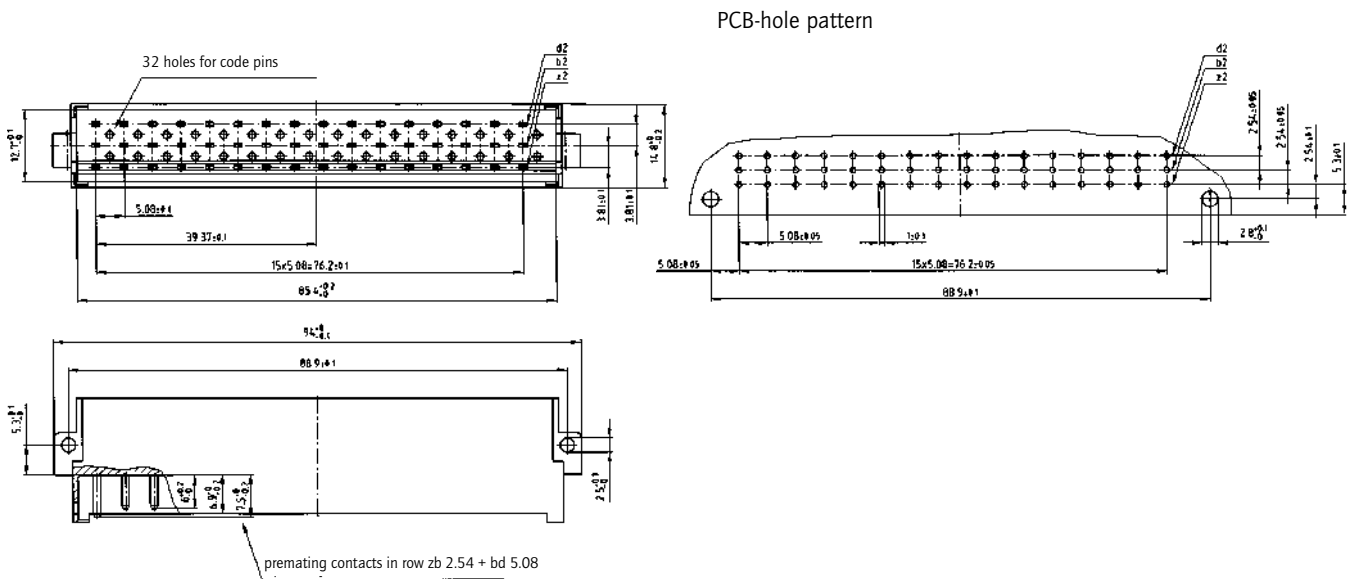

Solder pin angled contact spacing 5.08 mm

Solder pin angled contact spacing 2.54 mm

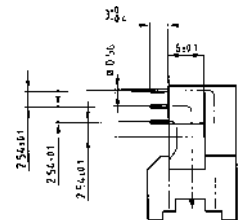
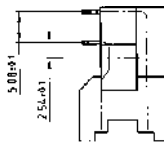

ORDER DATA

(Dim. = mm)

No. of Pos.	Row	• = contact, + = no contact				Contact spacing	Solder pin angled
		Pos.	2	4	6		
32	d		+	+	+	2.54 mm	121 A 10699 X
	b		•	•	•		
	z		•	•	•		
32	d		•	•	•	5.08 mm	121 A 10709 X
	b		+	+	+		
	z		•	•	•		
48	d		•	•	•	2.54 mm	121 A 10719 X
	b		•	•	•		
	z		•	•	•		

TYPE F

Female connector – straight – 32 and 48 positions

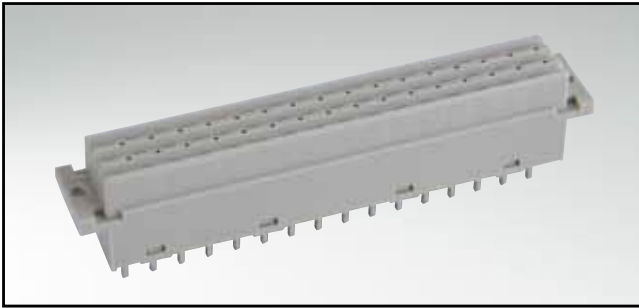

RoHS compliant

DESCRIPTION

- Solder pin, wire wrap and solder lug
- Quality class 3 (also available in quality class 2 or 1)
- Special assembly on request

PRODUCT DRAWING

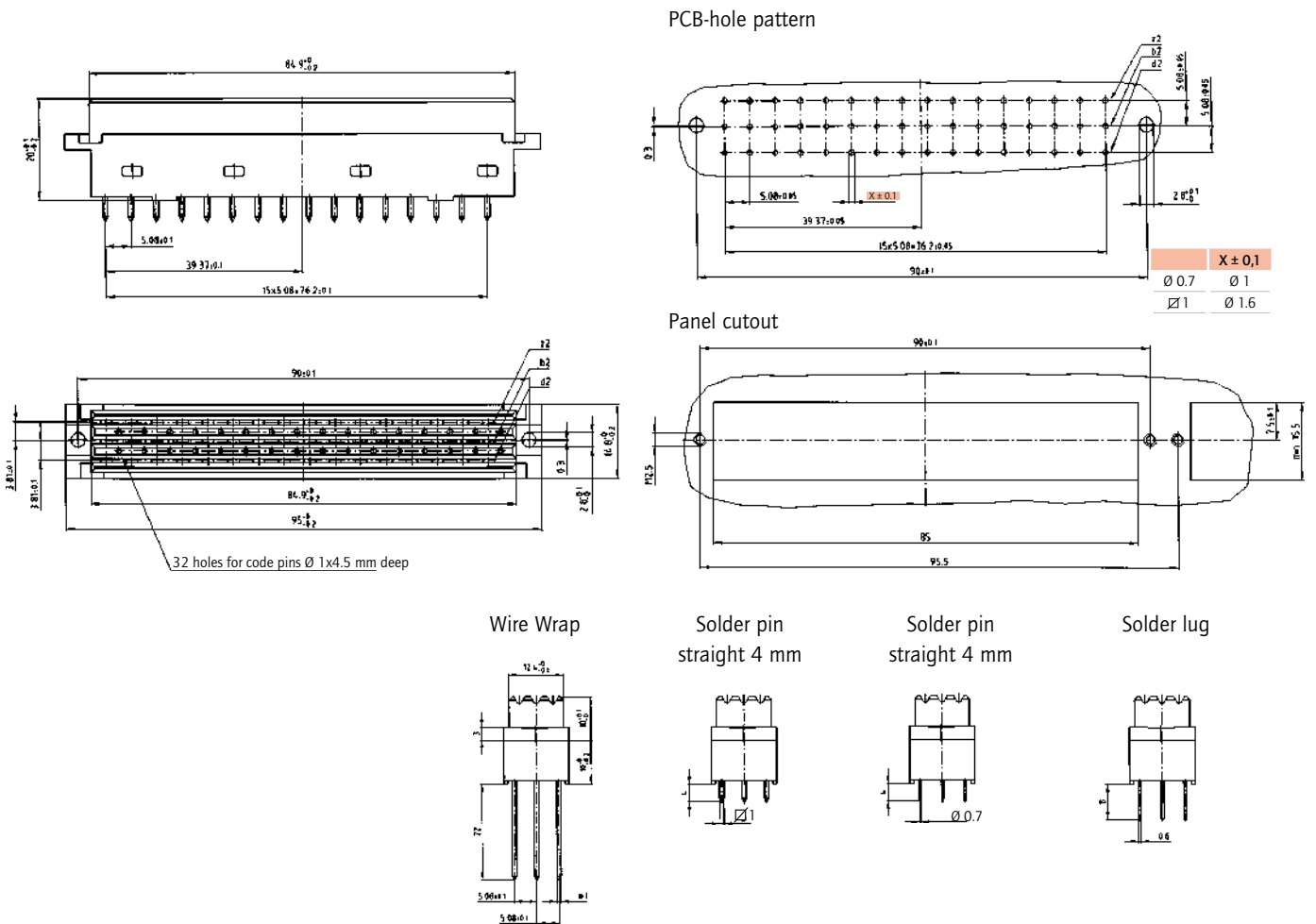

	$X \pm 0,1$
Ø 0.7	Ø 1
Ø 1	Ø 1.6

ORDER DATA

(Dim. = mm)

No. of Pos.	Row	• = contact, + = no contact				Wire Wrap	Solder pin straight Ø 1 mm	Solder pin straight Ø 0.7 mm	Solder lug
		Pos.	2	4	6				
32	z		•	•	•	•			
	b		•	•	•	•			
	d		+	+	+	+			
32	z		•	•	•	•			
	b		+	+	+	+			
	d		•	•	•	•			
48	z		•	•	•	•			
	b		•	•	•	•			
	d		•	•	•	•			

LOW PROFILE TYPE F

Female connector – straight – 32 and 48 positions

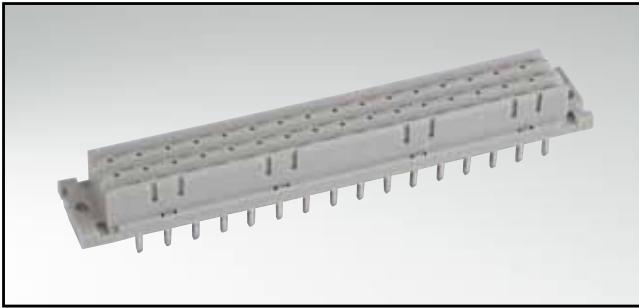

RoHS compliant

DESCRIPTION

- Solder pin
- Quality class 2 (other quality classes on request)

PRODUCT DRAWING

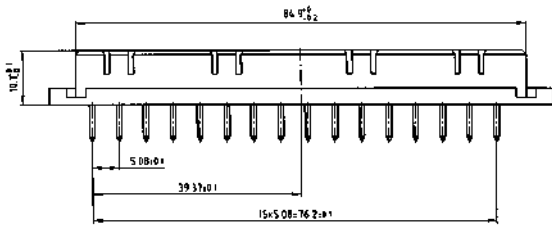

PCB-hole pattern

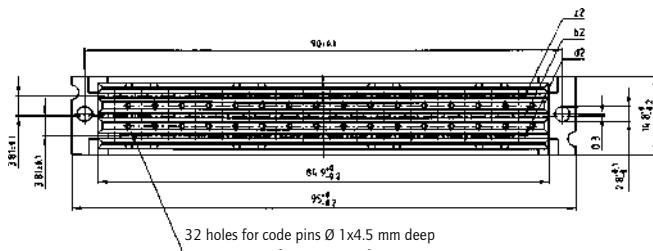
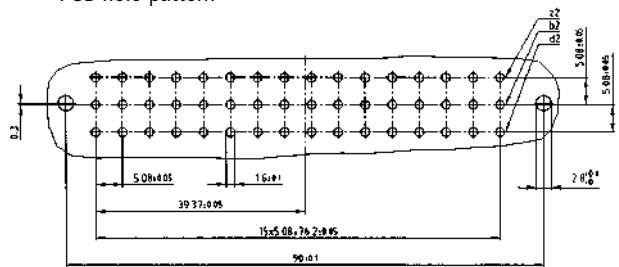

Panel cutout

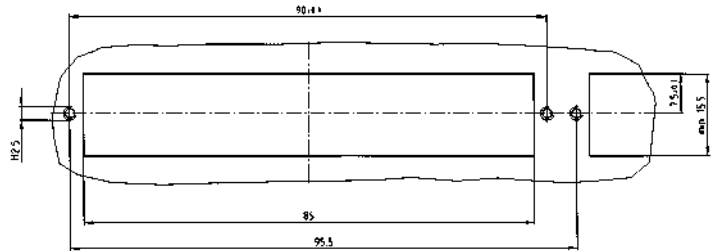

Solder pin straight

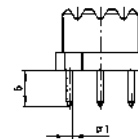

ORDER DATA

(Dim. = mm)

No. of Pos.	Row	• = contact, + = no contact				Solder pin straight
		Pos.	2	4	6	
32	z		•	•	•	122 B 11739 X
	b		•	•	•	
	d	+	+	+	+	
32	z		•	•	•	122 B 11749 X
	b	+	+	+	+	
	d		•	•	•	
48	z		•	•	•	122 B 11759 X
	b		•	•	•	
	d		•	•	•	

TYPE G

Female connector – straight – 64 positions

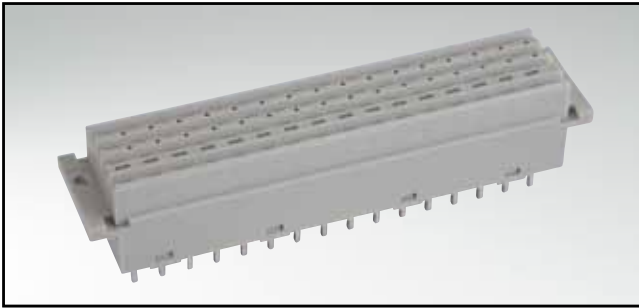

RoHS compliant

DESCRIPTION

- Solder pin and wire wrap
- Quality class 3 (also available in quality class 2 or 1)

PRODUCT DRAWING

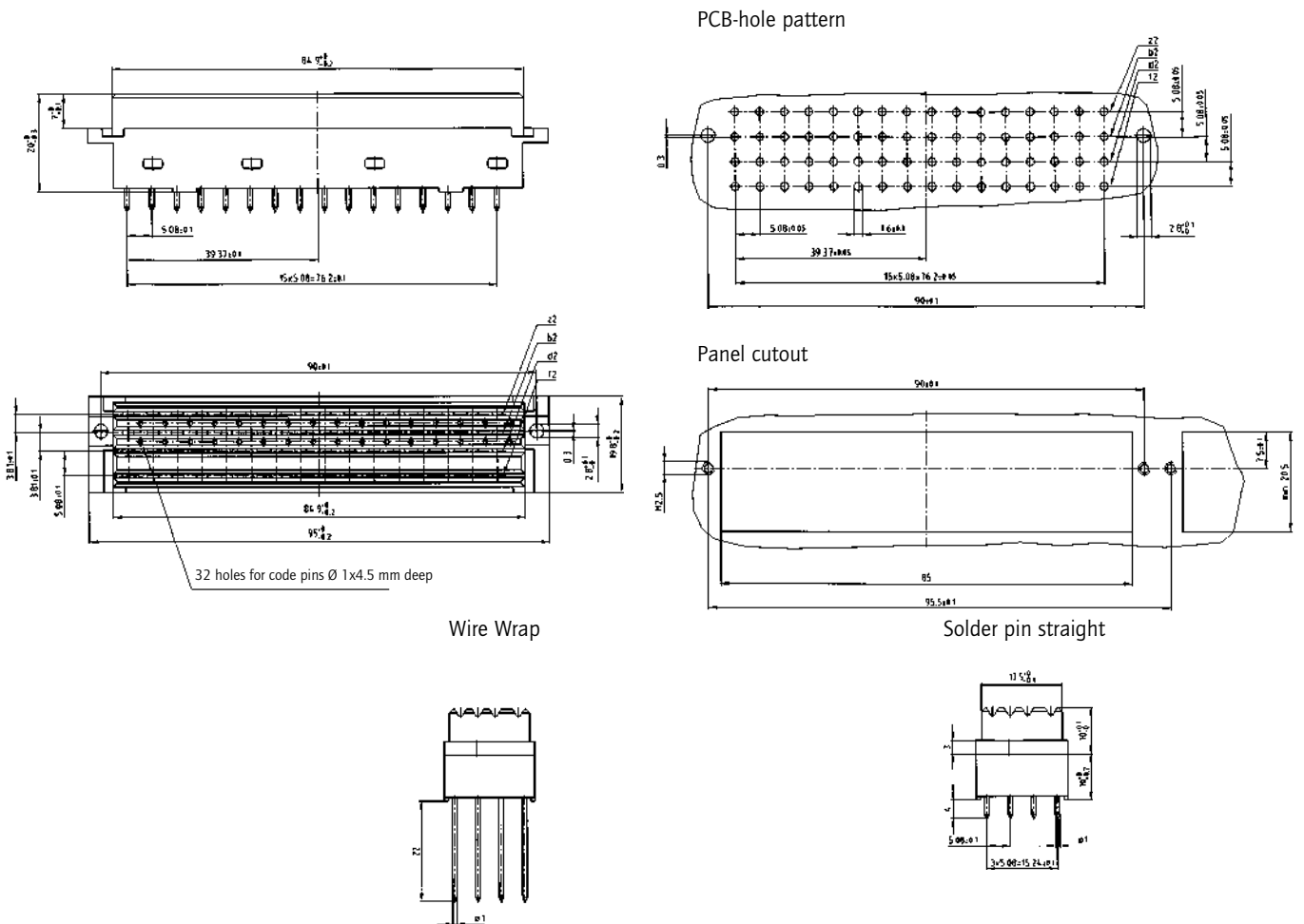

ORDER DATA

(Dim. = mm)

No. of Pos.	Row	Wire Wrap	Solder pin straight
64	z b d f	122 A 11129 X	122 A 11139 X

TYPE H

Male connector – angled – 15 positions

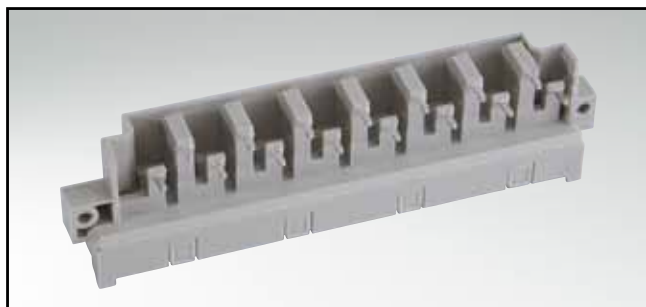

RoHS compliant

DESCRIPTION

- Solder pin
- With breakout area for coding
- Contact plating: silver
- Premating contacts in row "z" available

PRODUCT DRAWING

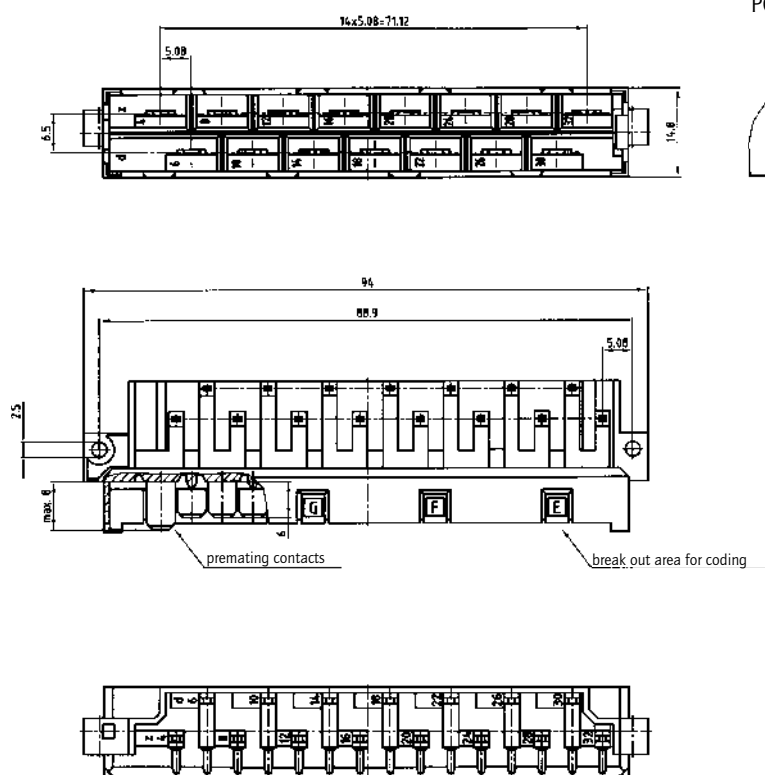

PCB-hole pattern

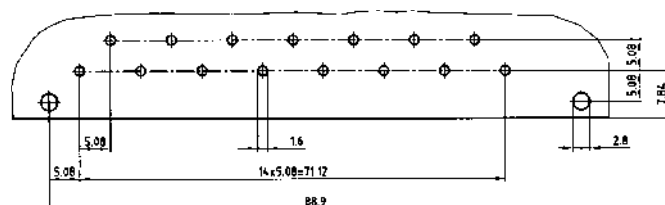

Solder pin angled

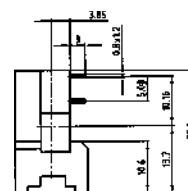

(Dim. = mm)

ORDER DATA

No. of Pos.	Premating contacts	Solder pin angled
15		121 E 21119 X
14 + 1	z 32	121 E 21109 X
13 + 2	z 4 + 32	121 E 21129 X

TYPE H

Female connector – straight and angled – 15 positions

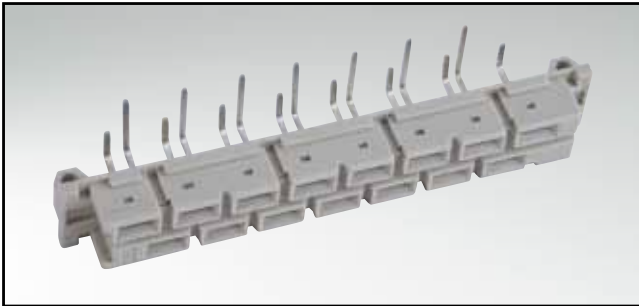

RoHS compliant

DESCRIPTION

- Solder pin, solder lug, Faston- and screw termination
- With breakout area for coding
- Contact plating: silver

PRODUCT DRAWING

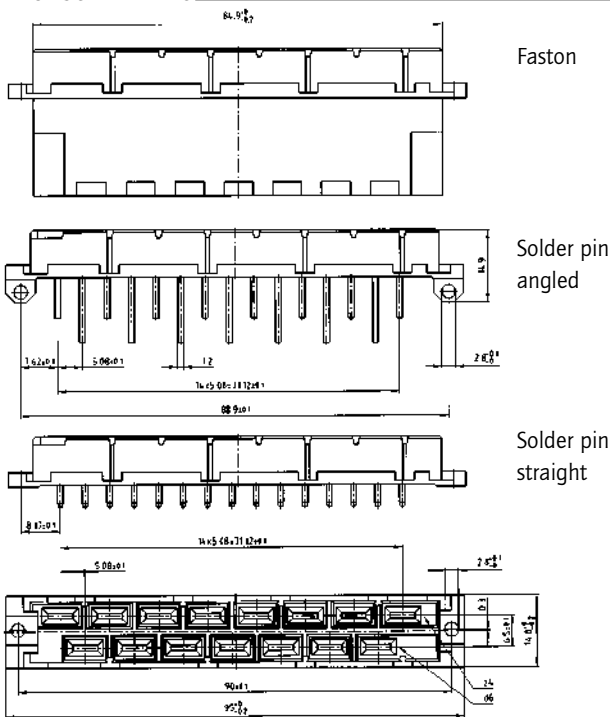

PCB-hole pattern

Solder pin angled 5.08 mm

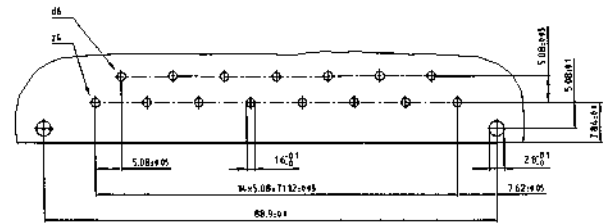

Solder pin straight 10.16 mm

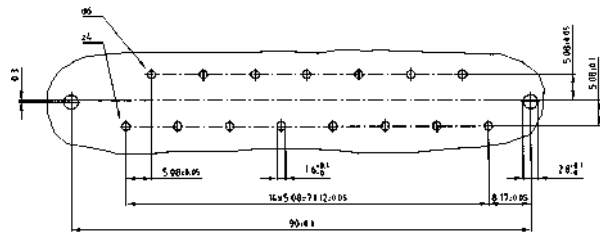

Faston

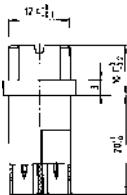

Screwed connection

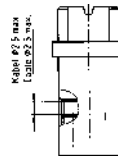

Solder pin straight 4.5 mm

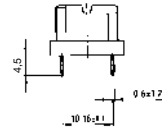

Solder pin straight 13 mm

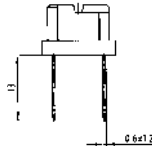

Solder lug

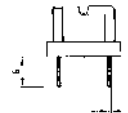

Solder pin angled

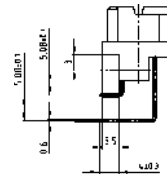

Coding piece



(Dim. = mm)

ORDER DATA

No. of Pos.	Faston	Screwed connection	Solder pin straight 4.5 mm	Solder pin straight 13 mm	Solder lug	Solder pin angled	Coding piece
15	122 E 11609 X	122 E 11619 X	122 E 11629 X	122 E 11639 X	122 E 11649 X	122 E 11659 X	120 X 10019 X

TYPE H

Male connector – angled – 11 positions

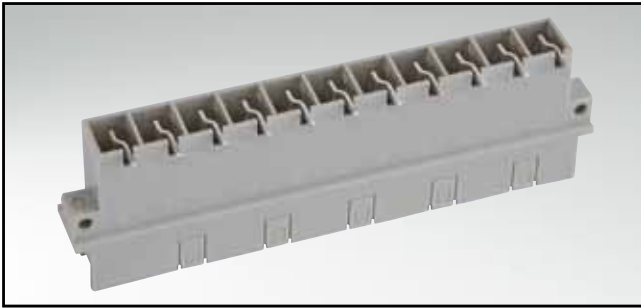

RoHS compliant

DESCRIPTION

- Solder pin
- With breakout area for coding
- Contact plating: silver
- Premating contacts in row "z" available

PRODUCT DRAWING

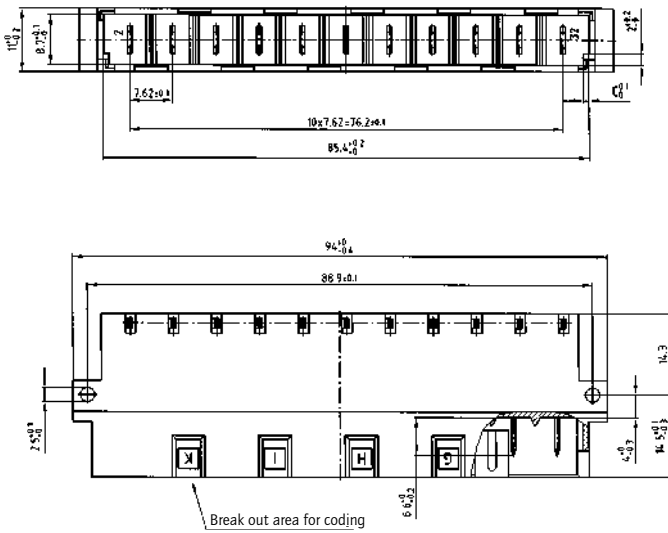

PCB-hole pattern

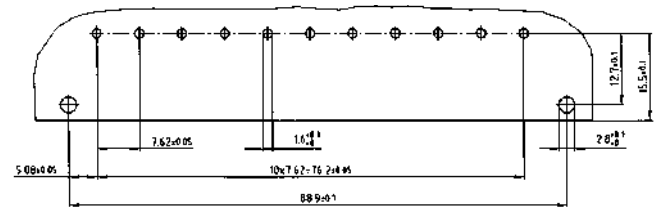

Solder pin angled

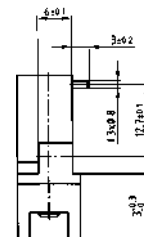

ORDER DATA

(Dim. = mm)

No. of Pos.	Premating contact	Solder pin angled
11		121 E 10949 X
10+1	z 32	121 E 10959 X

TYPE H

Female connector – straight – 11 positions

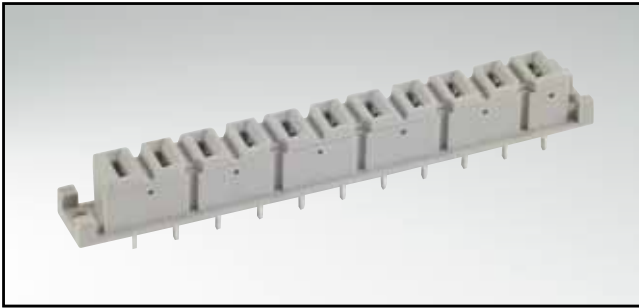

RoHS compliant

DESCRIPTION

- Solder pin and faston
- With coding area
- Contact plating: silver

PRODUCT DRAWING

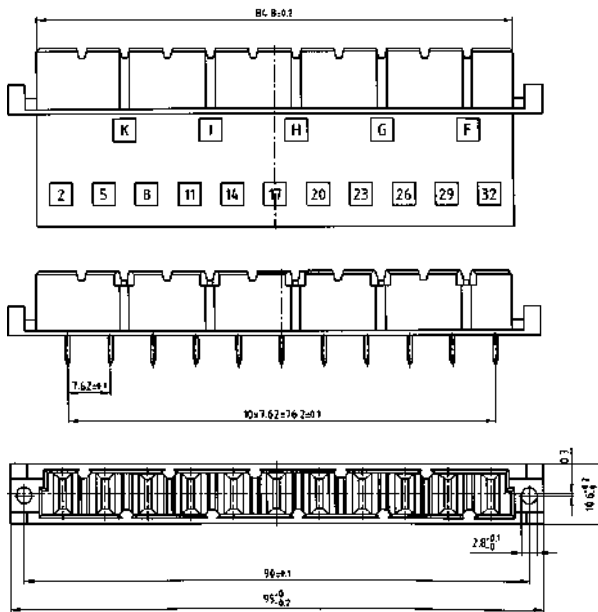

PCB-hole pattern

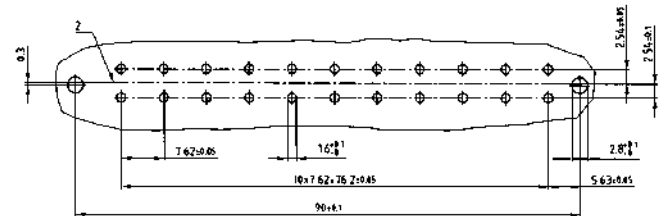

Faston

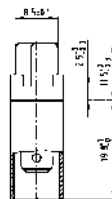

Solder pin straight

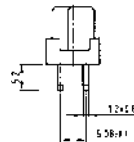

Coding piece



ORDER DATA

(Dim. = mm)

No. of Pos.	Faston	Solder pin straight	Coding piece
11	122 E 11709 X	122 E 11719 X	120 X 10019 X

TYPE F+H (MIXED CONNECTOR)

Female connector – straight – 24+7 positions

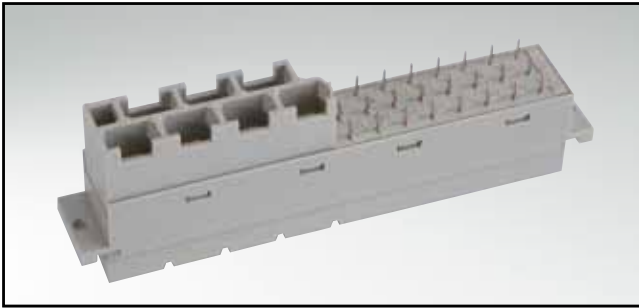

RoHS compliant

DESCRIPTION

- Solder pin und Faston
- Quality class 2

PRODUCT DRAWING

Panel cutout

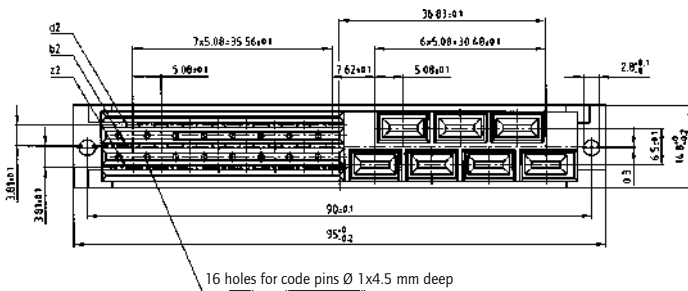
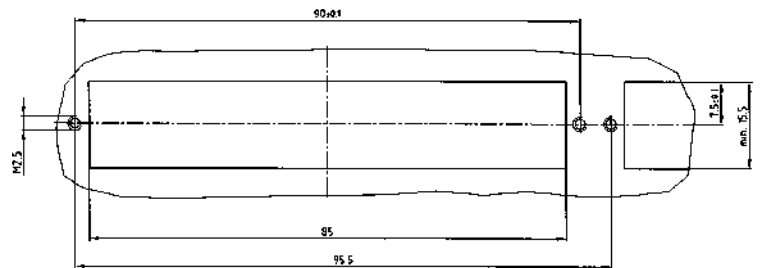
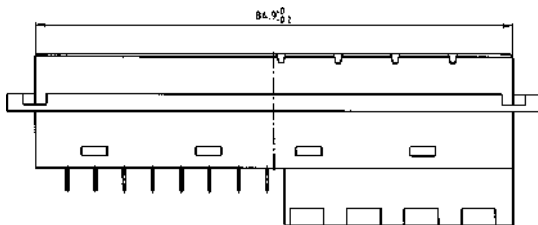

Solder pin / Faston

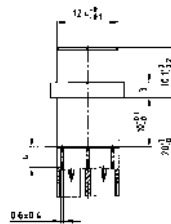

ORDER DATA

(Dim. = mm)

No. of Pos.	Solder pin / Faston
24+7	122 B 11159 X

TYPE C

Female connector – Insulation displacement termination (IDC) – 64 positions

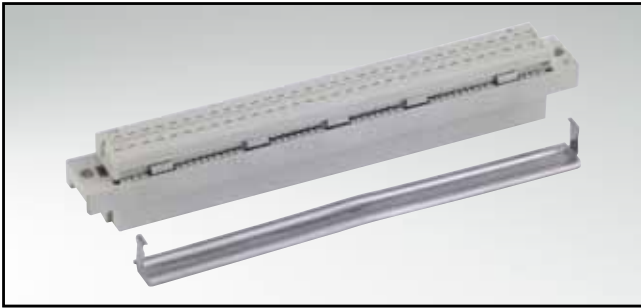

DESCRIPTION

- Ribbon cable termination
- Strain relief need to be ordered separately
- Quality class 3 (also available in quality class 2 or 1)

PRODUCT DRAWING

Female connector with strain relief

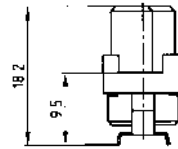
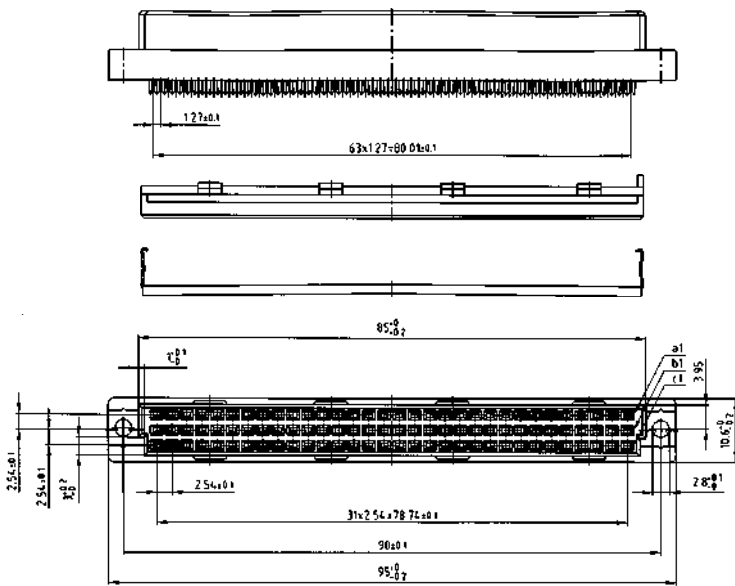

Female connector without strain relief

Strain relief

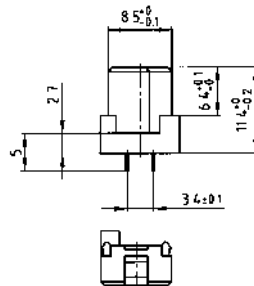

ORDER DATA

(Dim. = mm)

No. of Pos.	• = contact, + = no contact					Female connector without strain relief	Strain relief	
	Pos.	1	2	3	4			5
64	a	•	•	•	•	122 A 11699 X	120 X 10169 X	
	b	+	+	+	+			+
	c	•	•	•	•			•

INTERCONNECTION HOUSING

Housing and locking clips for type C and R



DESCRIPTION

- Usable for female connectors type C and R
- Locking-clips to secure and to unlock the female connector
- For PCB which a thickness from 3.2 to 3.6 mm and a pin length of 13 or 17 mm

PRODUCT DRAWING

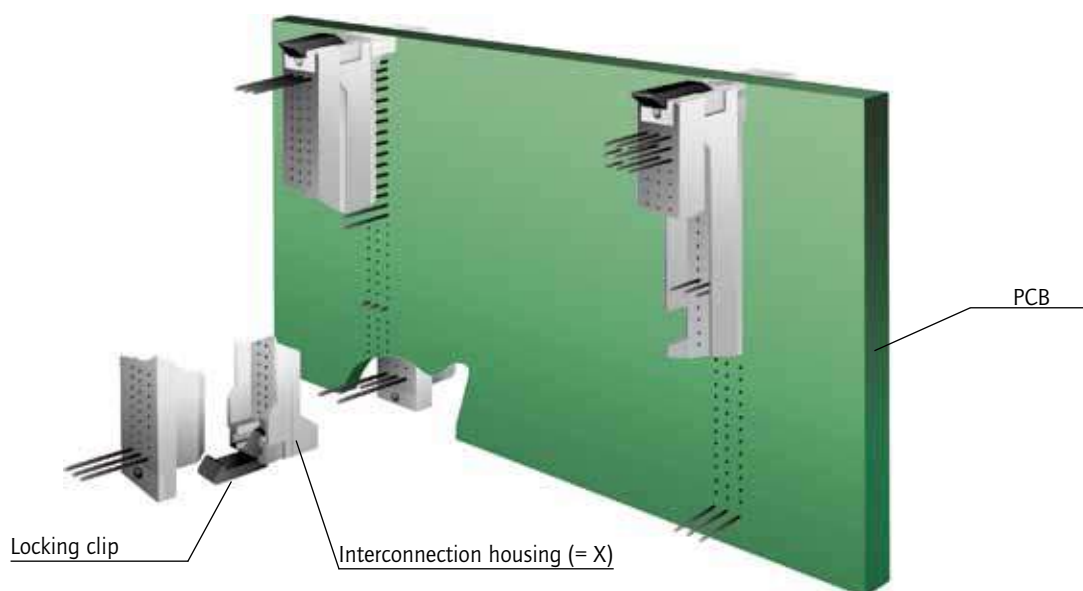

ORDER DATA

(Dim. = mm)

No. of Pos.	X (mm)	Interconnection housing	LOCKING CLIPS	
			Type C	Type R
96	4.6	120 X 10089 X	120 X 10129 X	120 X 10149 X
96	8.6	120 X 10099 X	120 X 10129 X	120 X 10149 X
96	9.3	120 X 10109 X	120 X 10129 X	120 X 10149 X
96	10.0	120 X 10119 X	120 X 10129 X	120 X 10149 X

PLUG-IN FRAME

Frame for printed circuit boards (PCB)



RoHS compliant

DESCRIPTION

- For DIN EN 60603-2 and DIN 41617 connectors
- For PCB width 100 mm and 102 mm
- Material: polycarbonat, grey
- Other colours on request
- Mounting set needs to be ordered separately

PRODUCT DRAWING

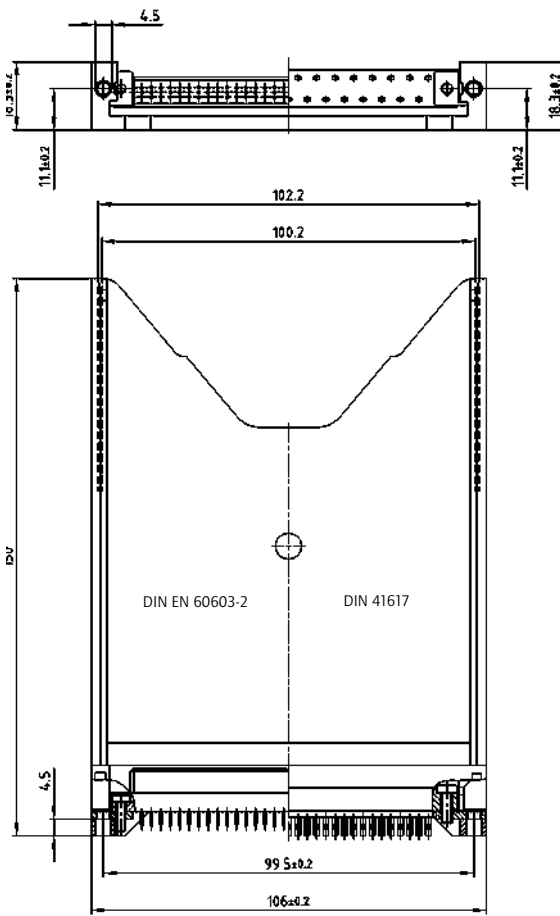

Mounting set for
DIN EN 60603-2

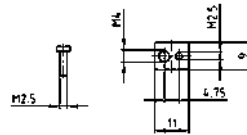

Mounting set for
DIN 41617

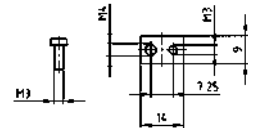

ORDER DATA

(Dim. = mm)

PLUG-IN FRAME		MOUNTING SET FOR	
grey – 100 mm	grey – 102 mm	DIN EN 60603-2	DIN 41617
120 X 10029 X	120 X 10039 X	120 X 10059 X	120 X 10049 X

CODING STRIPS

For connectors DIN EN 60603-2 (DIN 41612)

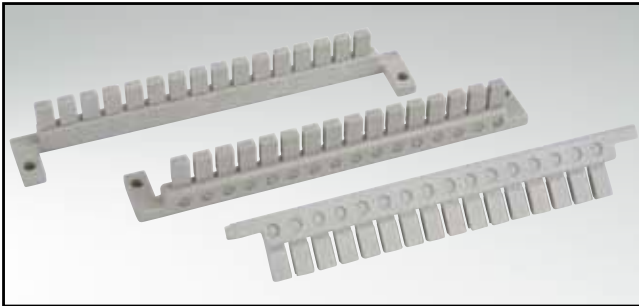

RoHS compliant

DESCRIPTION

- Mounting style:
 - inside the enclosure (mounting bar)
 - on printed circuit board (PCB)
- Optional coding by removing the segments

PRODUCT DRAWING

Type D, E, F

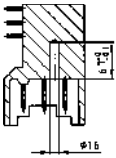

Type R, H

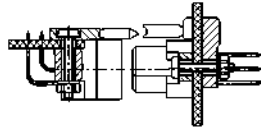

Type C, R, D

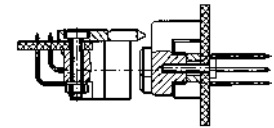

Coding pin

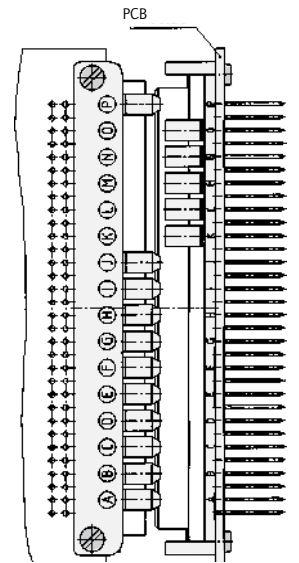
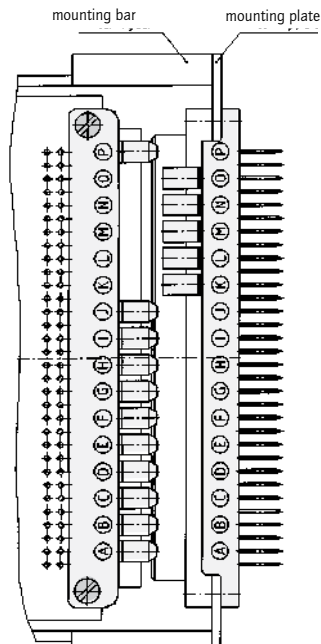
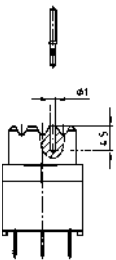

ORDER DATA

(Dim. = mm)

CODING PIN	Female connector (mounting plate)	CODING STRIPS FOR Male connector	Female connector (PCB)
120 X 10319 X	120 X 10379 X	120 X 10359 X	120 X 10369 X