



COMPRESSED AIR AND PROCESS FILTRATION





Solutions backed by experience, know-how and responsibility

Our passion is to add value to our customers by providing future-oriented compressed air and process filters and systems that are optimized from standpoints of energy consumption, efficiency and cost effectiveness. We are certain that our state of the art facilities, coupled with our extensive technical experience and engineering expertise, will guarantee excellence in the solutions we deliver.

As a technology-driven organization we've been strongly investing in research and development serving as incubator for the development of all products marked with the "Turbo D".

Our global network of scientists and engineers is continuously developing next-generation products and services. While continuously pursuing innovation and new technologies in design, manufacturing and delivery, we are also sharply focused on environmental issues, energy and resource management as well as corporate health and safety. We believe in sustainability that pays off!

Let us guide you through the specification and development of energy-efficient and cost-effective filtration solutions.

Feel free to contact us on CAP-europe@donaldson.com

ABOUT DONALDSON

Everything from one single source

100 years of filtration experience

Donaldson is a leading worldwide provider of filtration solutions and media manufacturer covering the entire process chain. From development through production to distribution and maintenance – you can get everything from one single source.

Since 1915, our innovative technologies improve people’s lives, enhance equipment performance and help to protect the environment. We are a technology-driven company that promises no less than the best solutions for high quality compressed air purification, sterile air, steam and liquid filtration.

Our products are engineered to

- improve filtration efficiency
- extend filter lifetime
- guarantee a maximum of energy savings
- ensure a high product quality

This is included in our first class service:

- Total customer care commitment
- Service for compressed air purification
- Leading filtration expertise
- Local presence

Versatile filtration solutions for compressed air applications

The Ultra-Filter was developed on the basis of worldwide experience and innovative designs for highly efficient and economic filtration technology.

- A flow-optimised filter design guarantees minimum pressure loss
- The innovative filtration technology ensures high separation efficiency
- An intelligent overall concept for unrivalled efficiency
- New filtration technology UltraPleat™ reduces the differential pressure and this with consistently high filtration performance
- Validated performance data acc. to ISO 12500-1 (oil aerosols), 12500-2 (oil vapours) and 12500-3 (particles)
- Reliable achievement of the compressed air quality to suit the application acc. to ISO 8573-1
- 1935/2004/EC approved for indirect food contact

Worldwide service



Total filtration service for compressed air.

Success factors of the UltraPleat™ technology



The proven UltraPleat™ technology is available for filter elements S and M.

PURIFICATION OF COMPRESSED AIR, GASES AND LIQUIDS

Tailor-made solutions for your application

Compressed air purification

Donaldson delivers a complete system of filtration and separation products for compressed air systems. Donaldson's technology in the field of compressed air, gas and liquid separation extends from the compressor room to all points of use in the factory. Components are designed and matched for optimal performance.

Donaldson's engineering service leads new products from concept to implementation. The product portfolio covers industrial filters, refrigeration and adsorption dryers as well as condensate treatment.

Process filtration

Where quality requirements are exceptionally high, Donaldson has a selection of process filters which will enable you to reach maximum purity standards. For these purposes Donaldson supplies pre- and sub-micro filters for liquids, for compressed air, gases and sterile air systems.

Filter housings



Filter housings for the aeration on storage tanks.

Adsorption dryer and system solutions

Processing concepts consisting of filtration and drying are an integral part of various compressed air applications. Donaldson designs and manufactures complete solutions that are tailor-made to individual customer requirements. This guarantees high reliability and simultaneously efficient operation.

Ultracac™ Smart



Ultracac™ Smart heatless regenerated adsorption dryer for pure air.

How can we meet your filtration needs? Please contact us on CAP-europe@donaldson.com



PRODUCT HIGHLIGHTS

Innovation in Compressed Air Purification & Liquid, Sterile Air and Steam

Ultracac™ Smart

NEW!



The very quiet adsorption dryer Ultracac™ Smart offers a stable pressure dew point at minimal regeneration air requirements and innovative UltraPleat™ filtration technology.

More information on page 18.

Quiet,
modular,
Industry 4.0
ready

Ultra-Filter DF

**PROVEN
TECHNOLOGY**



New filtration technology UltraPleat™ reduces the differential pressure and this with consistently high filtration performance.

More information on page 14.

UltraPleat™
Technology

LifeTec™

NEW!



The new liquid process filtration range: High flow rate for sterile grade-filtration and high particle retention capacities for prefiltration.

More information on page 17.

**Excellent
flow rate**

LifeTec™ (P)-SRF C/V/X

NEW!



The new sterile air filters offer a high retention rate down to 3 nm (nanometers) and are reliable even under extreme conditions.

More information on page 17.

Suited for
the use in
applications with
VPHP and ozone
sterilization

DONALDSON WORLDWIDE

Donaldson is where you are

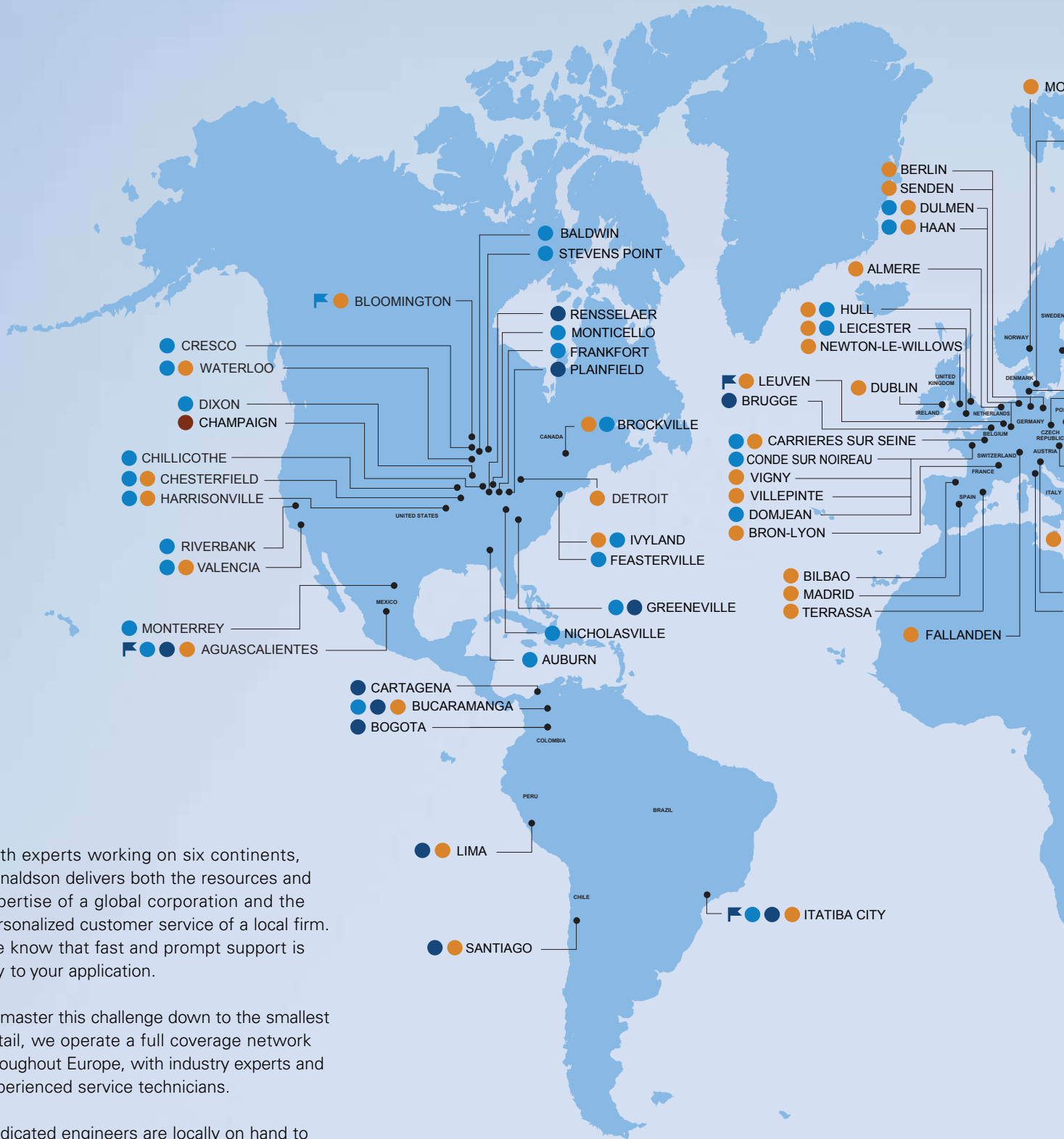

With experts working on six continents, Donaldson delivers both the resources and expertise of a global corporation and the personalized customer service of a local firm. We know that fast and prompt support is key to your application.

To master this challenge down to the smallest detail, we operate a full coverage network throughout Europe, with industry experts and experienced service technicians.

Dedicated engineers are locally on hand to assist or plan application specifications, implement system installation and look after ongoing maintenance.



Legend:

- World Headquarters
- Regional Headquarters
- Manufacturing
- Distribution Centers
- Joint Ventures
- Sales

INDUSTRIES AND APPLICATIONS

You are committed to manufacturing excellence – so are we

We offer a wide variety of tailor-made services for these applications. For example a complete filtration portfolio of innovative solutions for air & gas, steam and liquids. All products are designed to reach maximum purity standards and fulfil highest quality requirements.

Reliable product quality

All filter elements are produced, packaged and shipped under strict controls in an exact manner and meet the quality and performance data that are stored in the product specification.

Industrial machinery



Electrical machinery

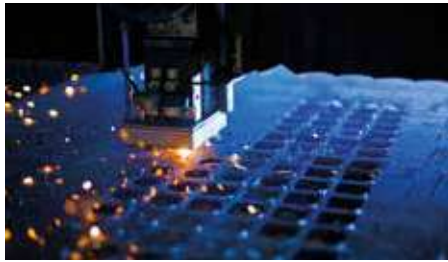

Automotive



Oil and gas



Industrial gases



Paints and coatings



Energy



Environment



Medical and hospitals



Feel free to send your request to CAP-europe@donaldson.com



Regardless of the filtration application you are responsible for: Donaldson is your partner! In decades of close cooperation with our customers, we have gathered expert knowledge in nearly all fields of industrial production.

Food processing



Food manufacturing



Dairies



Soft drinks and water



Winery



Breweries



Pharmaceutical



Chemical



Medical



Packaging and bottling



Beverages



Breathing air



COMPRESSED AIR PURIFICATION

Tailor-made solutions for compressed air purification

- 1 Compressor
- 2 **UFK-W** Aftercooler (water cooled)
- 3 **DF-C** Cyclone Separator
- 4 Air Receiver Vessel
- 5 **DF-V** Coalescence Filter (included in Buran DC)
- 6 Refrigeration Dryer (Buran DC incl. pre- and afterfilter)
- 7 **DF-M** Coalescence Filter (included in Buran DC)
- 8 **OFP 2000** Adsorption Dryer with Oil Vapour Adsorber
- 9 **DF-S** Particulate Filter
- 10 **DF-T** Three-Stage Filter (Coalescence Filter, Oil Vapour Filter, Particulate Filter)
- 11 **ALD** Adsorption Dryer (incl. pre- and afterfilter)
- 12 **AKC** Oil Vapour Adsorber
- 13 **DF-A** Oil Vapour Filter
- 14 **ALG-S** Breathing Air Unit
- 15 **UFM-D** Condensate Drain
- 16 **UFS-SP** Oil/Water Separator

Legend: — Compressed Air Condensate

Compressed air quality class	Dirt (solid particles) Maximum particle number per m ³ particle size, d in µm			Water Pressure dewpoint °C	Oil Concentration mg/m ³
	0.10 < d ≤ 0.5	0.5 < d ≤ 1.0	1.0 < d ≤ 5.0		
0	Specified acc. to application and better than Class 1				
1	20,000	400	10	≤ -70	≤ 0.01
2	400,000	6,000	100	≤ -40	≤ 0.1
3	n.s.	90,000	1,000	≤ -20	≤ 1
4	n.s.	n.s.	10,000	≤ +3	≤ 5
5	n.s.	n.s.	100,000	≤ +7	> 5

Compressed air quality acc. to ISO 8573-1

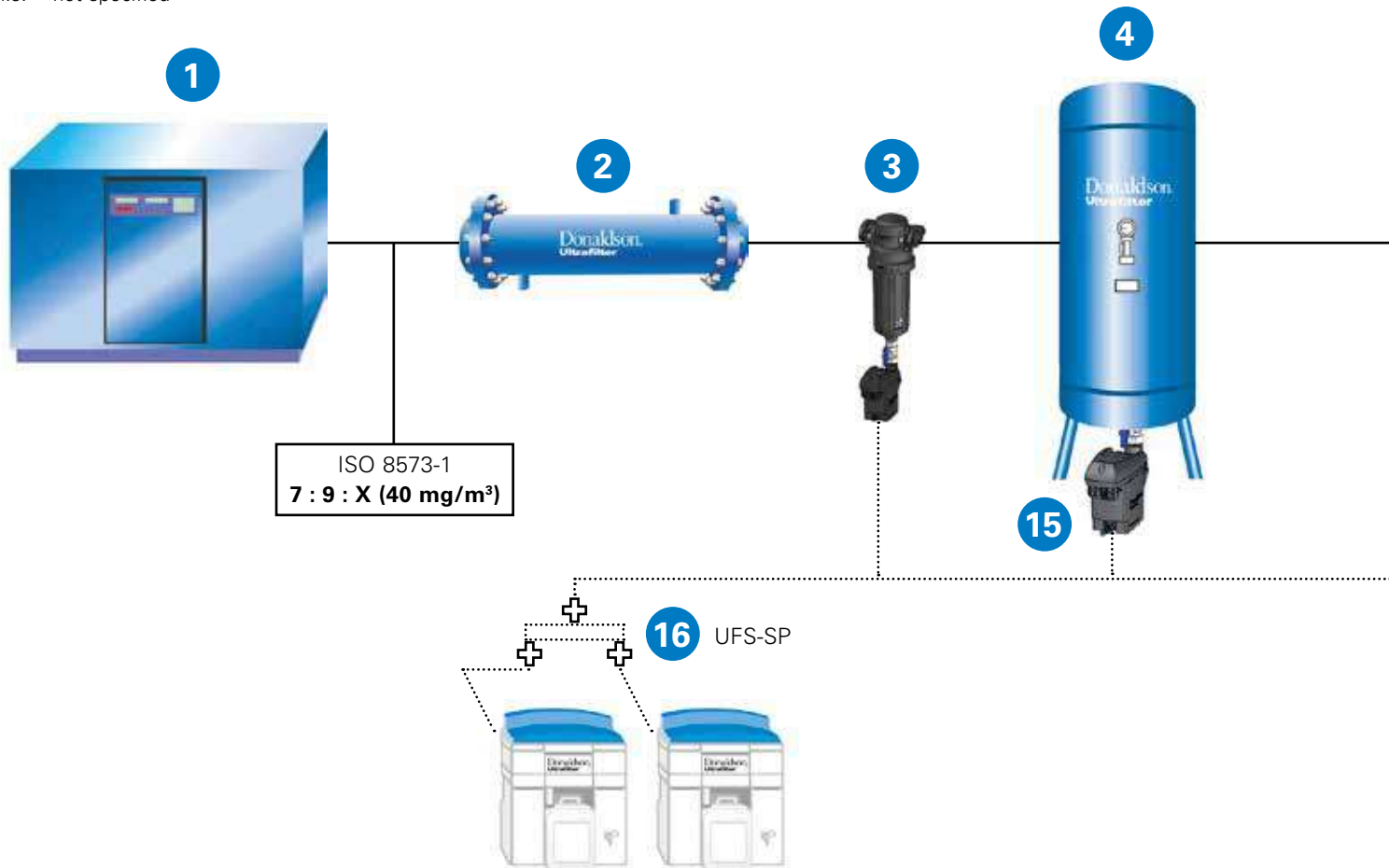

n.s. = not specified

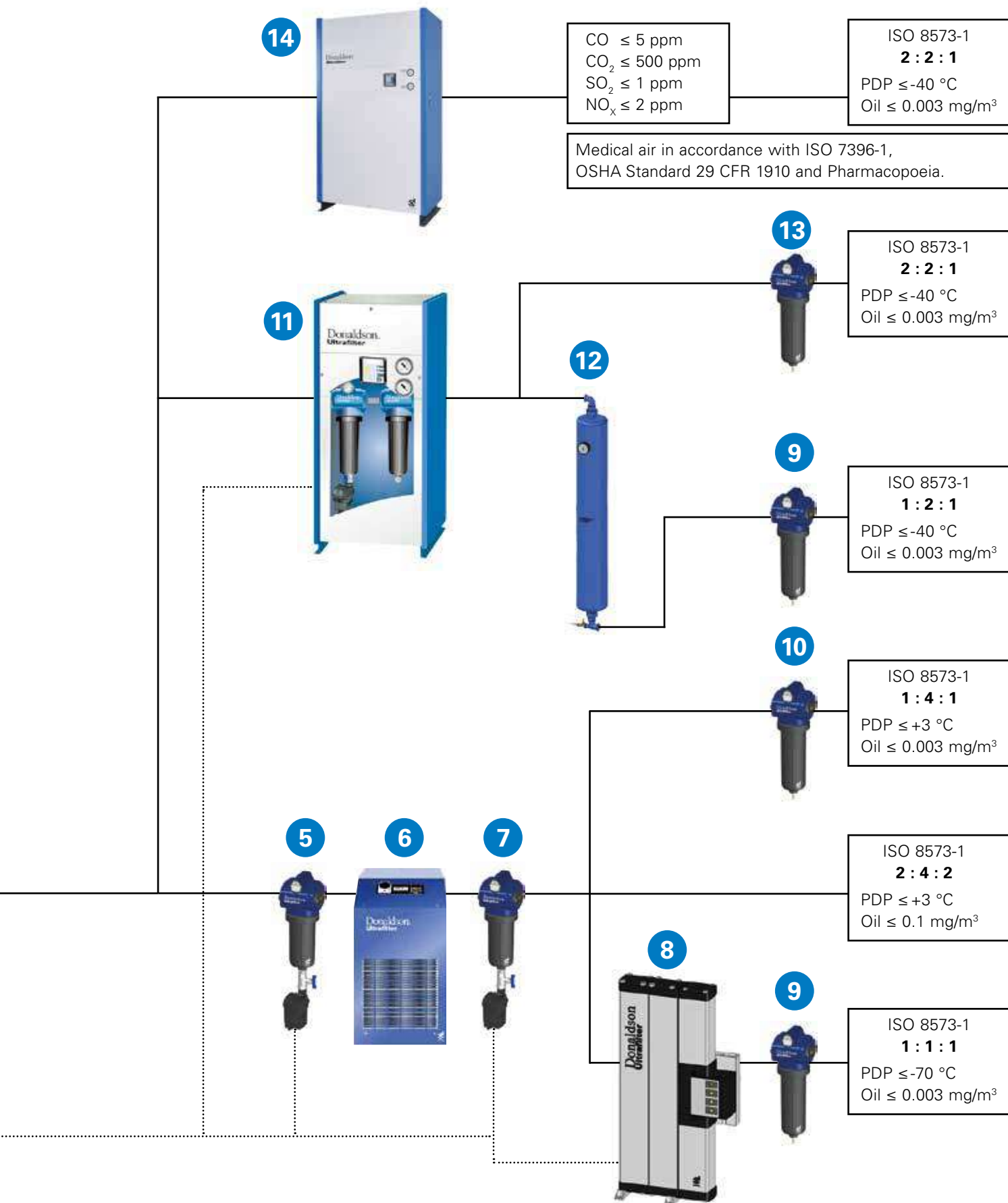









































PRODUCT FINDER

Compressed air

Water-free	Particle-free	Oil-free	Drying	Odour-free
<p>UFK-W </p> <p>UFK-L </p> <p>DF-C </p> <p>AG-Z </p> <p>SG-Z </p>	<p>DF </p> <p>SG </p> <p>DFX </p> <p>HD </p> <p>VX </p> <p>UltraPleat™ MX </p> <p>UltraPleat™ SX </p> <p>P </p> <p>B </p>	<p>DF </p> <p>SG </p> <p>DFX </p> <p>HD </p> <p>VX </p> <p>UltraPleat™ MX </p> <p>UltraPleat™ SX </p> <p>AX </p> <p>DF-T </p> <p>A </p> <p>V </p> <p>UltraPleat™ M </p> <p>UltraPleat™ S </p>	<p>Buran </p> <p>Boreas </p> <p>Brisa </p> <p>Bora </p> <p>SPN </p> <p>FRL </p> <p>Ultracac HED/ALD/MSD </p> <p>Ultracac™ Smart </p> <p>HLP </p> <p>HRE/HRS </p>	<p>ALG 20 </p> <p>ALG </p> <p>Ultracac 2000 Medipac 2000 </p> <p>Oilfreepac 2000 </p> <p>OFF </p> <p>Nitropac </p> <p>Ultracac Smart AKC </p> <p>AKC </p> <p>DFX </p> <p>AX </p> <p>DF-T </p> <p>A </p>

Process filtration

Sterile	Condensate	Steam	Gases	Liquid
<p>P-BE </p> <p>P-EG </p> <p>PG-EG </p> <p>LifeTec™ (P)-SRF C </p> <p>LifeTec™ (P)-SRF V </p> <p>P-SLF </p>	<p>UFM-D </p> <p>UFM-P </p> <p>UFS-SP N </p> <p>UFA-AC </p>	<p>P-EG </p> <p>P-EGS </p> <p>PG-EG </p> <p>(P)-GS N </p> <p>LifeTec™ (P)-GSL N </p> <p>(P)-GS VE </p>	<p>LifeTec™ (P)-SRF C </p> <p>LifeTec™ (P)-SRF V </p> <p>LifeTec™ (P)-SRF X </p> <p>LifeTec™ PT N </p> <p>P-EG </p> <p>PG-EG </p> <p>UFTD </p> <p>P-BE </p> <p>LifeTec™ (P)-GSL N </p> <p>R-EG </p>	<p>PF-EG </p> <p>P-KG </p> <p>(P)-SM N </p> <p>LifeTec™ PT N </p> <p>LifeTec™ PES WN </p> <p>LifeTec™ PP 100 N </p> <p>LifeTec™ PP 100 CN </p> <p>LifeTec™ PP N </p> <p>LifeTec™ PP-TF N </p> <p>LifeTec™ PES BN A </p> <p>PP-FC PP-FC 100 </p> <p>LifeTec™ (P)-GSL N </p>

COMPRESSED AIR FILTRATION AND PURIFICATION

Compressed air filter Ultra-Filter DF



Ultra-Filter DF

- Flow rate from 35 m³/h to 1,100 m³/h
- Flow-optimised filter housing and filter element design
- Validated performance acc. to ISO 12500-1 (oil aerosols), ISO 12500-2 (oil vapours) and ISO 12500-2 (particulates)
- Outer and inner surfaces protected against corrosion
- Compact, service-friendly design due to bayonet-fixing, low space requirement and simple handling during filter element exchange
- Economizer function with digital differential pressure gauge

High pressure filter housing HD

- Working pressure 20 bar to 400 bar
- Suitable for compressed air and technical gases

DFX filter housings

- Housings made of aluminum, designed for operating pressure up to 25 bar and operating temperatures from -20 °C up to +120 °C

Silicone free filters

- Specifically designed for use in the automotive and paint industries

Three stage filter DF-T



DF-T (three) stage filter

- This unique filter element combines three high efficiency purification stages in one single element
- Sub-micro coalescence filter
- Activated carbon adsorbent
- High efficiency particle filter
- Nominal flow rates up to 110 m³/h @ 7 bar
- Economizer offers control filter lifetime and differential pressure
- Compact space saving solution for point of use application
- Service advantages vs. multiple housing combination

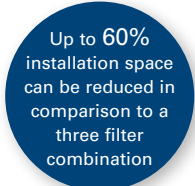

Cyclone Separator DF-C



Cyclone Separator DF-C

- Cyclone Separator will remove bulk water, oil droplets as well as solid particulates from the compressed air stream
- Innovative spin insert ensures low differential pressure and simultaneously lowered requirements of energy, the cyclone separator offers substantial cost savings
- High retention rates over large flow range
- Bayonet fixing between housing head and bowl for ease of inspection and cleaning
- DF-C Superplus including UFM-D condensate drain

MEDICAL AND BREATHING AIR SYSTEMS

Ultrapure ALG 20



Ultrapure ALG 20

- Flow rate of 60 m³/h
- Four persons can be provided with breathing air
- Portable version in stable housing with 2 or 3 filter stages, depending on the contamination of the compressed air
- Easy maintenance and filter change
- ATEX version available

Ultrapure 2000



Ultrapure 2000

- Purification package including adsorption dryer, CO, CO₂, NOX and SO₂ removal, pre-, afterfilter and automatic condensate drain
- Breathing air quality in excess of all relevant international standards
- Compact, modular and space-saving design solution
- Adsorbent in cartridges for easy and clean exchange

Ultrapure ALG



Ultrapure ALG

- Breathing air system with adsorption dryer
- CO, CO₂, SO₂, NOX precipitation to meet all relevant international breathing air specifications
- Cabinet design solution
- Pre- and afterfilters included; zero-loss condensate drain on prefilters
- Optimal adaption and generous dimensioning of all components for long lifetimes of processing stages and low differential pressure
- Controller including operating status LED, alarm and service messages

COMPRESSED AIR FILTRATION

Compressed air filter housings



AG & SG filter housings

- Flow rate from 1,440 m³/h to 2,880 m³/h (AG) and from 1,080 m³/h to 38,400 m³/h
- Low pressure drop
- Include differential pressure gauge
- SG available with ATEX specification
- Maximum working pressure 16 bar

AG-Z & SG-Z Cyclone Separators

- Flow optimised filter housing design
- Cyclone Separator will remove bulk water, oil droplets as well as solid particulates from the compressed air stream
- Retention rate > 99% for particle size of 10 µm and larger
- AG-Z Superplus including UFM-D condensate drain

Compressed air filter elements

**PROVEN
TECHNOLOGY**



Filter elements

- Available as prefilter and activated carbon filter
- UltraPleat™ filtration technology
- Low differential pressure
- High dirt holding capacity
- Longer service life
- Lowest filtration costs
- Validated performance acc. to ISO 12500-1 (oil aerosols), ISO 12500-2 (oil vapours) and ISO 12500-2 (particulates)

Replacement filter



Replacement filter elements

- Improved filtration efficiency
- Lower differential pressure
- Longer service life
- Lower filtration costs
- Higher efficiency
- Better energy savings
- Lower initial and operational costs
- Hundreds of varieties to choose from stock

FILTERS FOR LIQUIDS, STERILE AIR AND STEAM

Sterile air filter

NEW!



LifeTec™ (P)-SRF C/V/X

- High retention rate down to 3 nm (nanometers)
- High temperature and mechanical resistance
- Reliable under extreme conditions
- Last for more than 160 sterilization cycles
- Suited for the use in applications with VPHP and ozone sterilization

Suitable for temperatures up to +200 °C

Steam filter

PROVEN TECHNOLOGY



LifeTec™ (P)-GSL N

- High dirt holding capacity at a low differential pressure and a high flow rate
- Can be regenerated by back washing and ultrasonication
- Retention rate > 99.996 % at 0.01 µm
- Suitable for temperatures from -20 °C up to +200 °C
- Also available as 5 µm grade for culinary steam
- Suitable for food contact use acc. to CFR Title 21 & 1935/2004/EC

Retention rate down to 0.01 µm in saturated steam

Liquid filter

NEW!



LifeTec™

- LifeTec PES-WN sterile filters with retention rates of 0.2, 0.45 and 0.6 µm
- LifeTec PP100 N series with absolute retention rates of 0.6, 0.8, 1.0, 2.4, 5 and 10 µm
- Outstanding flow rate
- Highly resistant materials
- Extremely low adsorption of proteins
- High thermal stability, permanently hydrophilic
- Approved for food contact use acc. to CFR Title 21 & 1935/2004/EC
- A selection of stainless steel housings for your application are available

Food approved

ADSORPTION DRYERS

Heatless regenerated adsorption dryers

NEW!



Ultracompact™ Smart

- Compact design with integrated pre- and afterfilter
- Exceptionally quiet
- Modular and space-saving design
- Flow rate 5 to 100 m³/h
- Stable dew point -40 to -70 °C

Ultracompact Smart AKC

- Integrated oil indicator
- Flow rate 5 to 100 m³/h
- Residual oil vapor content ≤ 0,003 mg/m³

Heatless regenerated adsorption dryers



Ultracompact HED/ALD/MSD

- Complete and compact purification package with pre- and afterfilter
- Flow rate 5 m³/h to 1,000 m³/h
- PDP -40 °C/-70 °C

Heat regenerated adsorption dryers



HRE

- All climate zones
- Very flexible solutions
- Low investment costs
- Easy maintenance

HRS

- High energy-saving (zero purge, low desorption temperature)
- Low operating costs
- Easy maintenance

HRS-L

- Worldwide applicable
- Energy-saving (zero purge)
- Low operating costs
- Easy maintenance
- Pressure dew point up to -70 °C

Further adsorption dryers concepts ARBG Biogas are available on request.

REFRIGERATION COMPRESSED AIR AND MEMBRANE DRYERS

Refrigeration compressed air dryer



Buran

- Flow rate 20 m³/h to 1,175 m³/h
- Reliable pressure dew point +3 °C
- Corrosion resistant aluminium heat exchanger
- Plug & play solution; with integrated filters for 20 m³/h – 850 m³/h range
- Environmentally friendly refrigerant R407c/R134a with high overload capacity

Refrigeration compressed air dryer



Boreas

- Volume flow 1,260-21,000 m³/h
- Variable speed control (energy savings under partial load conditions)
- Electronic-level-controlled condensate drain on the heat exchanger

Bora

- Flow rate 25 - 6,060 m³/h
- Working pressure up to 45 bar
- Ideal for PET applications
- Hot gas bypass control

Membrane dryer



VarioDry SPN

- Very low purge air
- Lightweight design
- Nine types with 3.0 m³/h up to 63 m³/h
- Dew point reduction down to -40 °C or variable reduction
- Diagonal cross wrapped fibres
- Maintenance free and easy to install
- No electrical supply required
- Almost noiseless operation
- SPN Superplus including prefilter

OUR BROCHURE OVERVIEW

Get more information on demand

Level 1: Corporate Brochure



Level 2: Area Brochures



You are here

Level 3: Product Brochures



Level 4: Technical Data Sheets



Level 5: Manuals



More information about our products on www.donaldson.com



Compressed Air Filtration · Filters for Sterile Air, Steam and Liquids · Refrigerant Drying · Adsorption Drying · Condensate Drains · Condensate Purification Systems · Process Air and Gas Processing



Total Filtration Management
Donaldson offers a wide variety of solutions to reduce your energy costs, improve your productivity, guarantee production quality and help protect the environment.

Total Filtration Service
A comprehensive range of services keeps your production at peak performance and at the lowest total cost of ownership.

<p>Donaldson Filtration Deutschland GmbH Haan, Germany donaldson.com shop.donaldson.com</p>	<p>Australasia 61-02-4350-2066 marketing.australia@donaldson.com Brazil 55-11-4894-6035 vendas.brasil@donaldson.com China 86-400-921-7032 info.cn@donaldson.com EMEA 49-2129-569-0 cap-europe@donaldson.com</p>	<p>India 91-124-4807-400 indiaenquiries@donaldson.com Japan 81-42-540-4123 ndl-ultrafilter-web@donaldson.com Korea 82-2-517-3333 cap-kr@donaldson.com Latin America 52-449-300-2442 industrialair@donaldson.com North America 800-543-3634 processfilters@donaldson.com South Africa 27-11-997-6000 samarketing@donaldson.com Southeast Asia 65-6311-7373 sea.salesenquiry@donaldson.com</p>
---	--	--

F117085 ENG COMPRESSED AIR AND PROCESS FILTRATION
© 2017 Donaldson Co., Inc. All Rights Reserved. Donaldson and the color blue are marks of Donaldson Company, Inc. All other marks belong to their respective owners. (Contains Donaldson proprietary technology.)