

P  **R**  **D** **O** **X**[®]
S E C U R I T Y S Y S T E M S

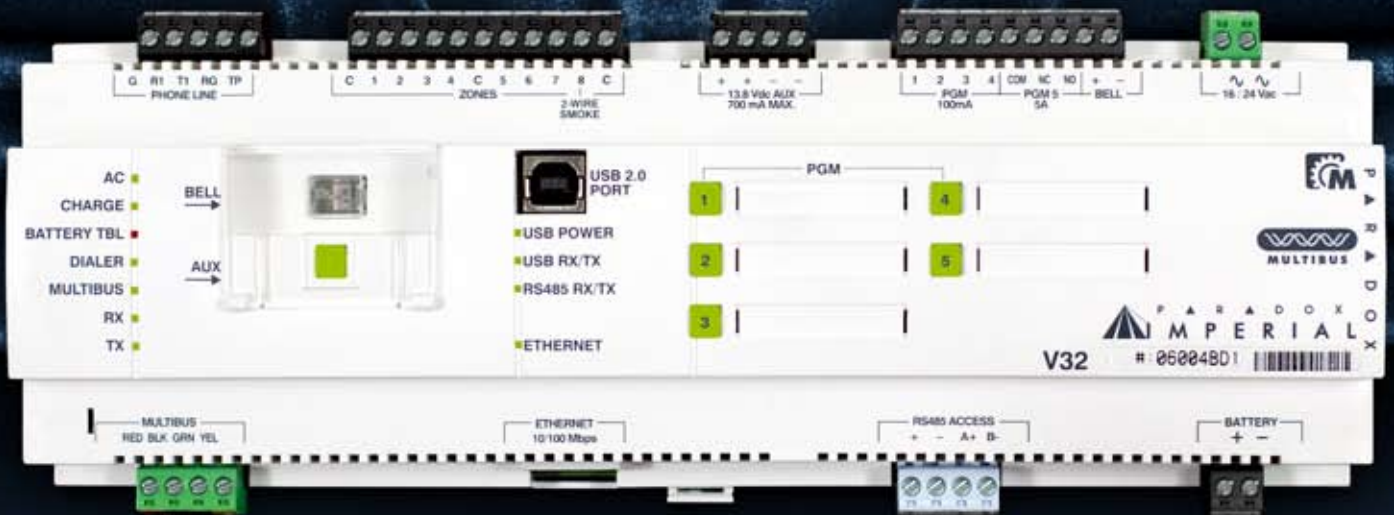

PRODUCT CATALOGUE 2009

1st edition (5th revision)



See page 3 for more information.



Home Automation



Partitions



Zones



Users and Cards



Doors



Modules



TCP/IP Built-In



GPRS & SMS

CONTROLLER



V32
Imperial Controller

BABYWARE



BabyWare
Software

HOME AUTOMATION



DIM1D (110/220Vac)
1-Channel Light Dimmer Module

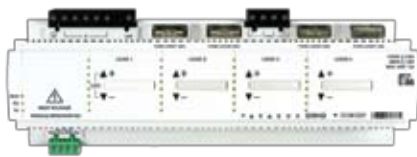

DIM4D (110/220Vac)
4-Channel Light Dimmer Module



HV8D
8 Output 110/220Vac Module



LV8D
8 Output Low-Voltage Module



USER CONTROLS

(Custom colours available, please contact us)



MSA4H / V
4 Button Wall Switch



MCB1H / V
1 Dial / 4 Button Combo Wall Switch



MSA8H / V
8 Button Wall Switch



MVCA2
2 Dial Dimmer Wall Switch

ACCESS CONTROL

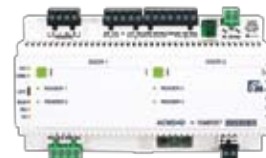

ACM24D
Stand-Alone, 2-Door 4-Reader Access Control Module

POWER SUPPLY AND HUB

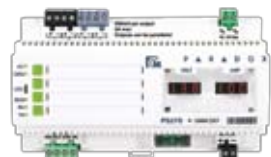

PS27D
4-Output 2.85A Power Supply Module

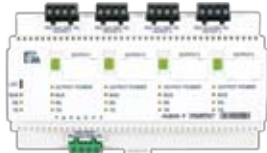

HUB4D
4 Port Hub and Bus Isolator Module



PS100D
Power Supply
(In: 110/220Vac, Out: 15Vdc/6.5A)

SYSTEM INPUTS



ZX32D
32 Zone/Input Expansion Module



ZX16D
16 Zone/Input Expansion Module



ZX8D
8 Zone/Input Expansion Module



DB608D
DIN Metal Box
With Door

KEYPADS



K656
LCD Keypad



K07C
Grafica Color LCD Keypad

2009

New Products

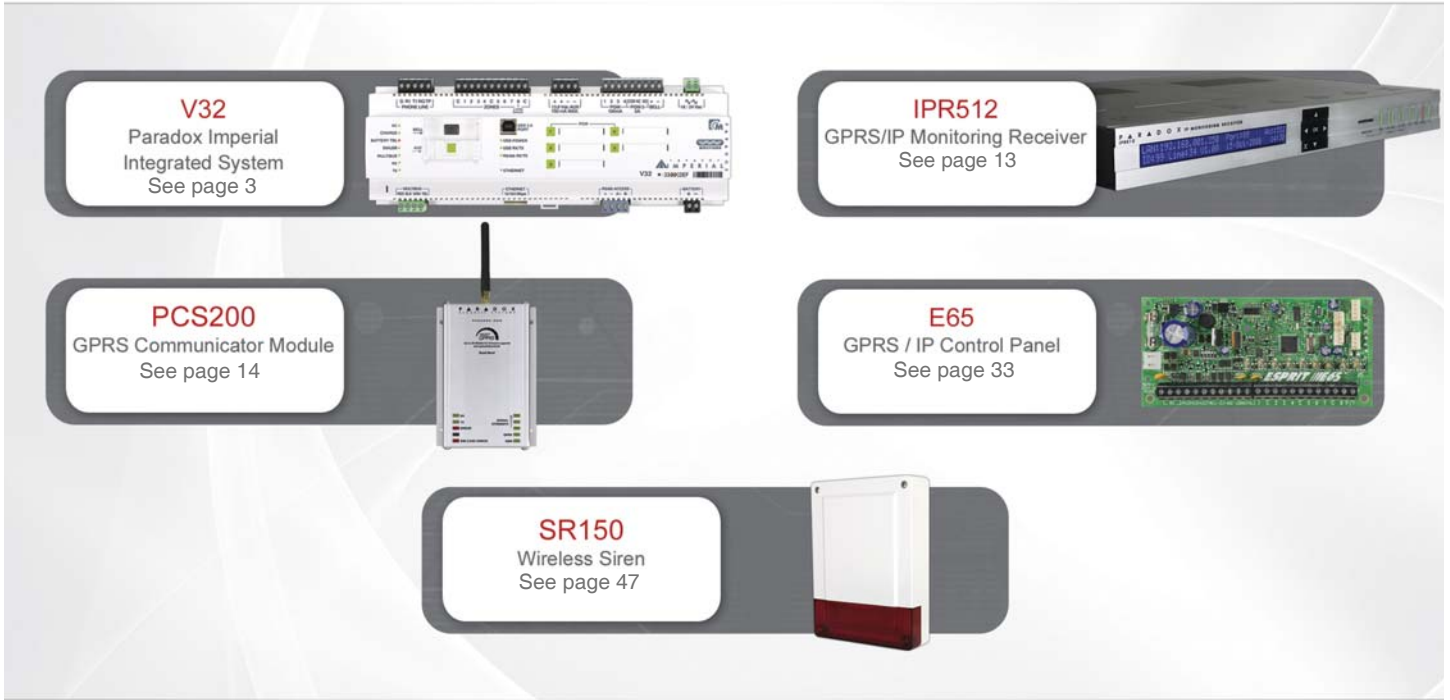

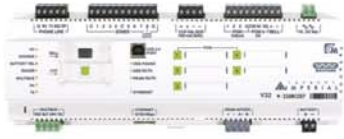

Table of Contents

	3
Communication Modules	13
Digiplex EVO High Security and Access Systems	17
Spectra SP Expandable Security Systems	28
Esprit E-Series Hardwired Security Systems	33
Magellan Wireless Transceiver Security Systems	36
Magellan All-in-One Wireless Consoles	41
Magellan Wireless Controls and Devices	44
Motion Detectors	49
Motion Detector Comparison Chart	54
Control Panel Comparison Chart	55

Controller



V32
Imperial Controller

BabyWare



BabyWare
Software

Home Automation



DIM1D (110/220Vac)
1-Channel Light Dimmer Module

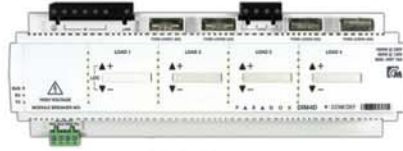

DIM4D (110/220Vac)
4-Channel Light Dimmer Module



HV8D
8 Output 110/220Vac Module



LV8D
8 Output Low-Voltage Module



Power Supply and Hub

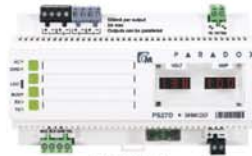

PS27D
4-Output 2.85A Power Supply Module



HUB4D
4 Port Hub and Bus Isolator Module



PS100D
(In: 110/220Vac,
Out: 15Vdc/6.5A)

System Inputs

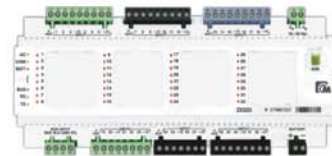

ZX32D
32 Zone/Input Expansion Module



ZX16D
16 Zone/Input Expansion Module

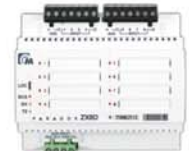

ZX8D
8 Zone/Input Expansion Module

Keypads



K656
LCD Keypad



K07C
Grafica Color LCD Keypad



DB608D
DIN Metal Box
With Door

Paradox Imperial Integrated System

The Imperial system was designed to offer true integration of home automation, access control, security, and the latest communication technology in combination with user-friendly programming, maintenance, operation, and site supervision. System architecture was designed to be simple, easy to install and troubleshoot, thus reducing labour and costs related to installation, programming, and maintenance. All system control modules are fully upgradeable through the communication bus, and are designed using a standard DIN Rail assembly, resulting in an installation that saves space, provides easy access and replacement, and offers a nice visual presentation of the system. A lot of research and development has gone into the Imperial system to provide a solution that fully adapts to any need, whether for private residential living or commercial management.

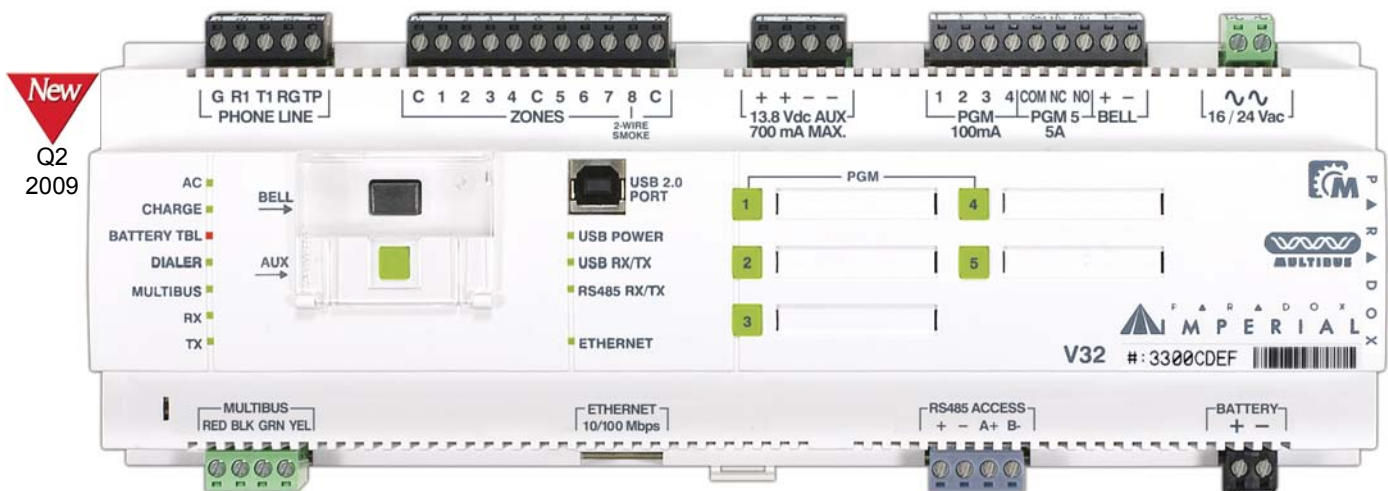
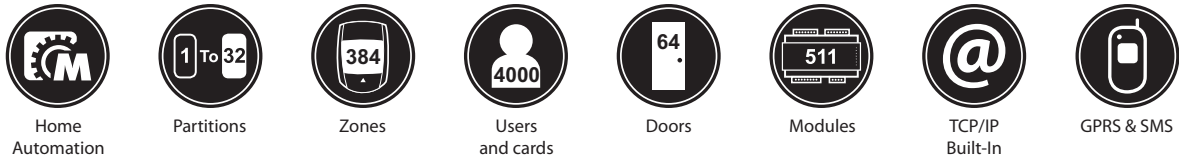

V32 | Paradox Imperial Integrated System

Multibus

- 4-wire encrypted 13.8Vdc communication bus at 500bps
- Multibus automatically switches to RS-485 at 57.6Kbps for bus module firmware upgrade
- In-field firmware upgrade for panel and multiple bus modules through the Multibus via local PC or remote GPRS/IP connection
- Support for up to 511 bus modules

Home Automation

- Imperial home automation is managed by the MAMA engine using MAMA output modules that control all high or low voltage outputs and MAMA wall switches. Together these modules offer full control of lights (toggle or dimming of incandescent and fluorescent lights), motors, shutters (multiple positions, not just fully open or fully closed), sprinklers (any number of valves activate in sequence or in parallel), air conditioning, heating, and more.
- Basic system capacity controls 8 MAMA outputs, purchase a license to increase to 32, 64, 128, 192, 256, 384, or 512 MAMA outputs.
- 16 macros per MAMA output module. Each output in the system can be controlled by a macro, which can be a system event, timing, sunset/sunrise, sensor input, or energy management feature.
- 10,000 home automation events buffered

Access Control

- Stand-alone operation with independent RS-485 output port
- 64 doors (basic system capacity supports 4 doors, purchase a license to increase to 16, 32, 48 or 64 doors)
- 3,744 access cards
- Ultra-fast response time
- 256 access levels
- 256 schedules
- 32,000 access control events buffered
- Simple 4-wire connections between module, controller and readers
- Anti-passback
- Door trap (man trap) applications

Security

- 32 partitions
- 384 zones (8 on-board zones inputs)
- 256 user codes
- 2,000 security events buffered
- Land line dialer output

Communication

- Built-in TCP/IP communication port (10/100Mbps) for upload/download via IP, event reporting to a Paradox IP Monitoring Receiver (IPR512), or firmware upgrades
- Supports PCS Series - GPRS/GSM Communicator Modules (see Communication Modules on page 13). Can be used in conjunction with VDMP3 Voice Module (see Communication Modules page 13)
- Patented 2 optocoupler dialer circuit - the most reliable dialer in the industry (US Patents 5751803, RE39406)
- 32 simultaneous local/remote BabyWare PC connections

Hardware

- DIN rail enclosure with removable terminals for fast, secure, orderly and cost-efficient installations
- 1.7A built-in switching power supply
- Transformer sharing enables modules to share central AC supply (16 to 24Vac) or DC supply (18 to 30Vdc) throughout the system
- 1 supervised auxiliary output with local control
- 4 on-board solid-state 100mA PGM outputs (+/- triggering) and 1 NC/NO 5A relay with local control
- 1 supervised bell/siren output
- 66MHz, 32-bit processor and 66MHz SDRAM clock
- 32MB memory on board for ultra fast communication with Imperial PC software, web page and event storage
- Super Capacitor (no battery) for real-time clock backup for up to 10 days (IP auto-clock adjust when available)
- Replace a V32 and download a backup from BabyWare in approximately 15 minutes

Features Common to all Imperial DIN Modules

- Connects to Multibus: 4-wire encrypted 13.8Vdc communication bus at 500 bps (except ACM24D when connected to RS-485 bus)
- Firmware upgradeable via Multibus using RS-485 at 57.6Kbps
- All programming is done using BabyWare PC Software
- DIN rail enclosure with removable terminals for fast, secure, orderly, and economic installations
- Supports 35mm DIN rail mounting
- Includes labels to identify each zone, door, or output

Software

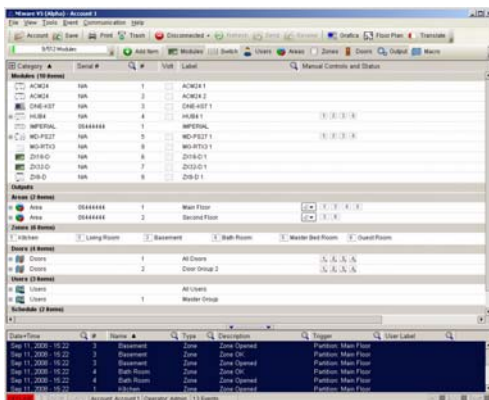

BabyWare

- Upload/download via GPRS (38K/bps), IP (128K/bps), or USB 2.0 (up to 12M/bps)
- Connect up to 32 PC users
- Same software for users and installers (user rights)
- Multi-account and multi-user capacity
- Controls firmware upgrade of control panel and system modules
- User friendly layout and operation
- Easy monitoring and site management tools
- Powerful and fast sort, search and print capability
- Auto backup for data and powerful undo and recycle bin features
- Locate module (selected module's LED will flash or will be highlighted in the software)
- Completely replace BabyWare with a full system backup in approximately 15 minutes

Home Automation Modules



DIM1D | 1-Channel Light Dimmer Module

- See features common to all Imperial DIN modules on page 4
- One high-voltage channel for:
 - Phase control dimming
 - Mark X fluorescent dimming
 - 0 to 10V fluorescent dimming
- Output rating: 1000W@230V / 500W@120V
- Maximum load: 4.4A
- On-board buttons to manually control dim level
- Dim intensity LED display
- 3-LED module status display

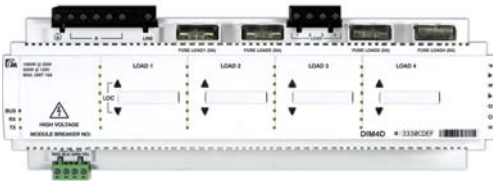

DIM4D | 4-Channel Light Dimmer Module

- See features common to all Imperial DIN modules on page 4
- Four high-voltage channels for phase control dimming
- Output rating: 1000W@230V / 500W@120V
- Maximum load: 4.4A per channel (15 total)
- On-board buttons to manually control dim level (per channel)
- Dim intensity LED display (per channel)
- 3-LED module status display

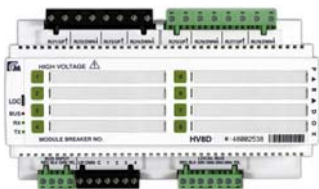

HV8D | 8 Output High-Voltage Relay Module

- See features common to all Imperial DIN modules on page 4
- 8 high-voltage relay outputs (110/240V, 10A resistive load)
- Motors up to 1/2hp (max 8A)
- 2 operating modes: relay mode and shutter mode
- Relay Mode:
 - 8 high-voltage devices
- Shutter Mode:
 - Outputs paired for up/down control of 4 shutters
 - Built-in calibration mode for open/close timing
 - Emergency stop
 - Global up/down for all connected shutters
- 8 on-board buttons to manually control each output (illuminates to show status)
- 3-LED module status display



LV8D | 8 Output Low-Voltage Relay Module

- 8 solid-state relay outputs (0-24V AC/DC, 400mA each)
- Connects to Multibus: 4-wire encrypted 13.8Vdc communication bus at 500bps
- Firmware upgradeable via Multibus using RS-485 at 57.6Kbps
- All programming is done using BabyWare PC Software
- DIN rail enclosure with removable terminals for fast, secure, orderly and economic installations
- Supports 35mm DIN Rail mounting.
- 8 on-board buttons to manually control each output (illuminates to show status)
- 3-LED module status display
- Includes labels to identify outputs

Access Control Modules



ACM24D | 2-Door 4-Reader Access Control Module

- See features common to all Imperial DIN modules on page 4
- Compatible with Imperial only
- Stand-alone operation via V32's independent 4-wire RS485 Access port (1000m/3000ft); all data is transferred to the ACM24D to ensure it continues to operate normally even if communication with the control panel is lost
- Module processes data locally, which provides ultra fast response time
- Connections for 2 doors (2 or 4 card readers, 2 REX devices, 2 door contacts and 2 lock outputs)
- Supports anti-passback and door trap (man trap) applications
- Reader port supports up to four R910/R915 4-wire card readers (up to 500mA)
- 4 inputs for 2 REX devices and 2 door contacts
- 2 lock outputs (6-12Vdc at 1A each)
- Lock output power jumper (select internal or external power supply)
- 2 external negative triggers: connect a PGM or push-button to unlock the door
- 2.85A switching power supply
- Transformer sharing: modules can share a central AC supply (16 to 24Vac) throughout the system
- Requires an AC or DC input voltage (16Vac to 24Vac or 16Vdc to 36Vdc)
- Simple 4-wire connections between readers, module and panel
- 2 on-board buttons to manually lock or unlock the doors (button illuminates to indicate status)
- 5-LED module status display and 4-LED reader status display
- Fully supervised (AC, battery, low battery and overload)
- Selectable battery charge current (300mA/500mA)
- Replace an ACM24D and upload a backup of all its cards and events in under 20 minutes



R910 | 4 Wire Epoxy-Sealed Indoor/Outdoor Proximity Reader

- Only 4 wires instead of 7 to connect with 4-wire access control modules
- In-field firmware upgradeable via CV4USB and WinLoad
- Adjustable red/green LED intensity and buzzer frequency
- Extreme weather-resistant design (epoxy-sealed)
- Tricolor LED display



R915 | 4 Wire Sealed Indoor/Outdoor Proximity Reader and Keypad

- Only 4 wires instead of 7 to connect with 4 wire access control modules
- In-field firmware upgradeable via CV4USB and WinLoad
- Adjustable red/green LED intensity and buzzer frequency
- Extreme weather-resistant design (injected rubber gasket and PCB cover)
- Tricolor LED display
- Available in 3 colors (white, silver and black)
- Also available: 915WB gang plate cover



C702

C706



C704/S



RAC1



RAC2

Proximity Cards

- **C702:** Clam Shell Card
- **C706:** 2 Sided High-Gloss ISO Card
- **C704/S:** Blue Proximity Key Tag
- **RAC1:** Magellan Remote Control with Integrated Access Card
- **RAC2:** Magellan Two-Way Remote Control with Integrated Access Card

Power and Hub Modules



PS27D | 4-Output 2.85A Power Supply Module

- See features common to all Imperial DIN modules on page 4
- Compatible with Imperial and Digiplex EVO
- 2.85A switching power supply
- Transformer sharing: modules can share a central AC supply (16 to 24Vac) throughout the system
- Requires an AC or DC input voltage (16Vac to 24Vac or 16Vdc to 36Vdc)
- 4 auxiliary outputs providing up to 500mA each
- Auxiliary outputs can be used in parallel to increase output current
- 7 segment display to display 3-digit voltage and 3-digit amperage of each output, sum of paralleled outputs or sum of all outputs
- Auxiliary outputs can be used as PGMs
- 4 on-board buttons to manually activate or deactivate each auxiliary output (button illuminates to indicate status)
- 5-LED module status display
- Fully supervised (AC, battery, low battery and auxiliary limit)
- Selectable battery charge current (350mA/850mA)



PS100D | AC/DC Switching Power Supply

- Supplies 100W at 16V (6.25A) to drive Imperial modules
- Universal AC input / full range (88-264Vac)
- Protections: Short circuit / Overload / Over voltage / Over temperature
- Cooling by free air convection
- LED indicator for power On
- No load power consumption < 1W
- Supports 35mm DIN Rail mounting

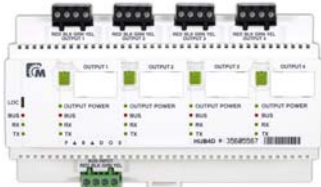

HUB4D | Hub and Bus Isolator Module

- See features common to all Imperial DIN modules on page 4
- Compatible with Imperial and Digiplex EVO
- One input port, 4 completely isolated output ports
- Each output port provides communications up to 900m (3000ft)
- Opto-isolated ports provide protection from high-voltage spikes (ideal for exterior lines)
- On-board buttons to manually activate or deactivate each hub output
- 4-LED status display per hub output
- 3-LED module status display
- Backup mode keeps module functioning if input signal is lost

Zone / Input and Wireless Expansion Modules



ZX32D | 32 Zone/Input Expansion Module

- See features common to all Imperial DIN modules on page 4
- Compatible with Imperial and Digiplex EVO
- 32 addressable zones
- LED zone status display
- Built-in 1.85A switching power supply
- Transformer sharing: modules can share a central AC supply (16 to 24Vac) throughout the system
- Requires an AC or DC input voltage (16Vac to 24Vac or 16Vdc to 36Vdc)
- Auxiliary outputs providing up to 1A
- On-board button to manually activate or deactivate each auxiliary output (button illuminates to indicate status)
- 6-LED module status display
- Fully supervised (AC, battery, low battery and auxiliary limit)
- Selectable battery charge current (350mA/850mA)
- Set a different input speed for each zone (up to 255 minutes), which is ideal for temperature monitoring applications
- Test mode tests each input



ZX16D | 16 Zone/Input Expansion Module

- See features common to all Imperial DIN modules on page 4
- Compatible with Imperial and Digiplex EVO
- 16 addressable zones
- LED zone status display
- Set a different input speed for each zone (up to 255 minutes), which is ideal for temperature monitoring applications
- Test mode tests each input



ZX8D | 8 Zone/Input Expansion Module

- See features common to all Imperial DIN modules on page 4
- Compatible with both Imperial and Digiplex EVO
- 8 addressable zones
- LED zone status display
- Set a different input speed for each zone (up to 255 minutes), which is ideal for temperature monitoring applications
- Test mode tests each input



RTX3 | Wireless Expansion Module

- Compatible with Spectra SP Series, Digiplex, Digiplex EVO, **and Imperial (Q2)**
- 32 wireless zones
- Maximum number of remote controls: 8 w/Esprit, 32 w/SP, 999 w/EVO and Imperial
- Remote control compatibility
 - Imperial/EVO/SP: REM1, REM2, REM3
 - E-Series/Stand-Alone: REM1
- Wireless PGMs (8 w/EVO and Imperial, 16 w/SP)
- **Supports SR150 Wireless Siren (Spectra SP only) see page 47**
- Functions with all MAGELLAN transmitters including 2WPGM
- Supports two RPT1 and eight K32LRF / K37 (Spectra SP only)
- In-field firmware upgradeable via CV4USB, 307USB, and Winload
- **In-field firmware upgradeable via multibus (Imperial only)**
- RF jamming supervision
- Low battery, tamper and check-in supervision
- Transmitter signal strength display
- 3 PGM outputs and 1 optional output
- Noise level test and indicator

User Controls



MSA4H/V | 4 Button Wall Switch

- 4 buttons to control any output (lights, sprinklers, etc.) or macros (group of outputs)
- Set in Toggle mode (1 button on/off) or Switch Mode (1 button on / 1 button off)
- Activation status LED per button
- Single gang box installation
- Backlit button identification
- Connects to Multibus: 4-wire encrypted 13.8Vdc communication bus at 500bps
- Firmware upgradeable via Multibus using RS-485 at 57.6Kbps
- All programming is done using BabyWare PC Software
- 3-LED module status display
- Includes labels to identify each button
- For customized colors, please contact us



MSA8H/V | 8 Button Wall Switch

- 8 buttons to control any output (lights, sprinklers, etc.) or macros (group of outputs)
- Set in Toggle mode (1 button on/off) or Switch Mode (1 button on / 1 button off)
- Activation status LED per button
- Single gang box installation
- Backlit button identification
- Connects to Multibus: 4-wire encrypted 13.8Vdc communication bus at 500bps
- Firmware upgradeable via Multibus using RS-485 at 57.6Kbps
- All programming is done using BabyWare PC Software
- 3-LED module status display
- Includes labels to identify each button
- For customized colors, please contact us



MVCA2 | 2 Dial Dimmer Wall Switch

- 2 rotary dials with push on/off action to dim outputs, such as lights or shutters or macros (group of outputs)
- 8 LEDs per dial to display light intensity or shutter position
- Global button per dial to control an alternate device or macro
- Backlight button to adjust LED light intensity
- Single gang box installation
- Connects to Multibus: 4-wire encrypted 13.8Vdc communication bus at 500bps
- Firmware upgradeable via Multibus using RS-485 at 57.6Kbps
- All programming is done using BabyWare PC Software
- 3-LED module status display
- For customized colors, please contact us



MCB1H/V | 1 Dial / 4 Button Combo Wall Switch

- Combines 4 buttons and 1 rotary dial to control/dim any output (lights, sprinklers, etc.) or macro (group of outputs)
- Set in Toggle Mode (1 button on/off) or Switch Mode (1 button on / 1 button off)
- Rotary dial features push button on/off control
- Activation status LED per button with backlit button identification
- 8-LED display for dial's light intensity or shutter position
- Global button to control an alternate device or macro with rotary dial
- Backlight button to adjust LED light intensity
- Single gang box installation
- Connects to Multibus: 4-wire encrypted 13.8Vdc communication bus at 500bps
- Firmware upgradeable via Multibus using RS-485 at 57.6Kbps
- All programming is done using BabyWare PC Software
- 3-LED module status display
- Includes labels to identify each button
- For customized colors, please contact us



WM100 | Surface Mount Switch Plate

- Alternative to gang box installation
- Fits all wall switches
- Convenient cable routing channel for clean installation
- For customized colors, please contact us

Keypads



K656 | Touch Sense LCD Keypad

- Compatible with Imperial
- Touch sense keypad interface
- Connects to Multibus: 4-wire encrypted 13.8Vdc communication bus at 500bps
- Firmware upgradeable via Multibus using RS-485 at 57.6Kbps
- All programming is done using BabyWare PC Software
- Display the status of up to 4 partitions and 384 zones
- Zone alarm display: the zones in alarm are shown until the system is disarmed
- 1 addressable zone
- Independently set chime zones
- 14 one-touch action buttons
- 3 keypad-activated panic alarms
- Adjustable backlight, contrast, and scroll speed





Q2 2009



K07C | 32-Partition Grafica Color LCD Keypad

- Upload photos or images using the SD slot
- Supports any two colors (16-bit) for background and text
- Supports full colour for screensaver display via integrated SD memory card
- Compatible with Imperial (Q2) and Digiplex EVO
- Firmware upgradeable via Multibus using RS-485 at 57.6Kbps
- Display the status of 32 partitions and 384 zones
- Zone alarm display: the zones in alarm are shown until the system is disarmed
- 1 built-in indoor temperature sensor
- 1 zone/temperature input. Connect a detection device or TEMP07
- Simple text-driven menus with step-by-step guidance
- Alarm clock and special reminders
- Up to 15 tunes for use with door chiming, entry delay, exit delay and more
- Independently set chime zones
- 3 keypad-activated panic alarms
- Supports up to 8 built-in user-selectable languages in three language sets
- Adjustable backlight, contrast and volume
- Available in two designer colors (silver or champagne)
- Dimensions (with door closed): 11.5cm x 17cm x 3cm (4.5in x 6.8in x 1.3in)
- 6.5cm x 6.5cm (2.6in x 2.6in) graphic LCD with a resolution of 128 x 128 pixels



K651 | 32-Character Blue LCD Keypad

- Compatible with Imperial and Digiplex EVO
- Connects to Multibus: 4-wire encrypted 13.8Vdc communication bus at 500bps
- Firmware upgradeable via Multibus using RS-485 at 57.6Kbps
- All programming is done using BabyWare PC Software
- Display the status of up to 4 partitions and 384 zones
- Zone alarm display: the zones in alarm are shown until the system is disarmed
- 32-character blue LCD with programmable labels
- 1 addressable zone
- Independently set chime zones
- 14 one-touch action buttons
- 3 keypad-activated panic alarms
- Adjustable backlight, contrast and scroll speed



TEMP07 | Temperature Sensor

- Connects to the Grafica's zone/temperature input to measure the external temperature
- Maximum distance from the Grafica: 30.5m (100ft)

Bus Motion Detectors



DMI50 | Dual Element Motion Detector Bus Module

- Compatible with Imperial and Digiplex EVO
- Connects to Multibus: 4-wire encrypted 13.8Vdc communication bus at 500bps
- All programming is done using BabyWare PC Software
- Patented Digital Motion Detection (no analog circuitry)
- Patented Auto Pulse Signal Processing
- Digital Shield algorithm software
- Automatic temperature compensation
- Single or dual edge processing
- Metal shield maximizes protection from EMI and RFI signals
- 12m x 12m (40ft x 40ft) range with 110° viewing angle



DMI60 | Quad Element Motion Detector Bus Module

- Compatible with Imperial and Digiplex EVO
- Connects to Multibus: 4-wire encrypted 13.8Vdc communication bus at 500bps
- All programming is done using BabyWare PC Software
- Patented Digital Motion Detection (no analog circuitry)
- Patented Auto Pulse Signal Processing
- Digital Dual Opposed Detection
- Interlock Sensor Geometry (ISG)
- Digital Shield algorithm software
- Automatic temperature compensation
- Single or dual edge processing
- Metal shield maximizes protection from EMI and RFI signals
- 12m x 12m (40ft x 40ft) range with 110° viewing angle



DMI70 | Digital Dual-Optic PIR Bus Module (40kg/90lb Pet Immunity)

- Compatible with Imperial and Digiplex EVO
- Connects to Multibus: 4-wire encrypted 13.8Vdc communication bus at 500bps
- All programming is done using BabyWare PC Software
- Dual optics (2 dual opposed element sensors)
- Provides superior pet immunity 40kg (90lb) using a patented combination of advanced optics and digital processing technologies
- Patented Digital Motion Detection (no analog circuitry)
- Patented Auto Pulse Signal Processing
- Digital Shield algorithm software
- Automatic temperature compensation
- Single or dual edge processing
- Metal shield maximizes protection from EMI and RFI signals
- 11m x 11m (35ft x 35ft) range with 90° viewing angle



DGI85 | Outdoor Digital Dual-Optic PIR Bus Module (40kg/90lb Pet Immunity)

- Compatible with Imperial and Digiplex EVO
- Connects to Multibus: 4-wire encrypted 13.8Vdc communication bus at 500bps
- All programming is done using BabyWare PC Software
- Impact and temperature resistant casing
- Operates at -35°C to +50°C (-31°F to +122°F)
- Casing lined with an injected rubber gasket
- UV protected lens
- Dual Optical Filtering System
- Multi-level sensitivity adjustment
- Dual optics (2 dual opposed element sensors)
- Provides superior pet immunity 40kg (90lb) using a patented combination of advanced optics and digital processing technologies
- Patented Digital Motion Detection (no analog circuitry)
- Patented Auto Pulse Signal Processing
- Digital Shield algorithm software
- Automatic temperature compensation
- Single or dual edge processing
- Metal shield maximizes protection from EMI and RFI signals
- 11m x 11m (35ft x 35ft) range with 90° viewing angle
- Two operational modes (bus mode for Imperial/EVO or conventional relay operation)
- Can be used with the Heavy Duty Outdoor Swivel Bracket (SB85)

System Accessories



JCB8 | Junction Box

- Easy connection for up to 8 parallel output connections
- Can be connected in daisy chain configuration
- Easy debugging of each bus tree
- Supports 35mm DIN Rail mounting
- LED confirms bus power (9V or more)



DB608D | DIN Metal Box with Plexiglass Door

- Specially designed to hold DIN modules
- Multiple modules can be set up on each row
- Bottom row used for easy access to batteries
- Plexiglass door with reversible hinges and locking mechanism
- 60cm x 76cm x 20cm (24in x 30.4in x 8in)



DIN Rails

- 15mm top-hat rail
- 1m (3'3") lengths
- Zinc electroplated with yellow chromate passivation
- Approximate Ampacity: 65A



DIN Rail Cutter

- Cuts TS35, TS35C/R, TS32, and TS15 DIN rails as well as 6 mm (1/4") steel rods
- Punches 8.8 mm x 5 mm (0.35" x 0.2") oblong holes in either direction on the axis of the rail
- Includes 1m ruler, end stop, and 73 cm (28") high leverage handle

Communication Modules

All Paradox control panels have been specifically built from the ground up to support the latest in communication technology, including GPRS, GSM, voice, and IP. Whether it be uploading/downloading via GPRS, monitoring and controlling your system remotely through a PC, receiving system status and events by voice or text message, or reporting to the monitoring station via GPRS or IP, all Paradox panels support various communication applications that heighten an installation's security.

IP Monitoring Receiver



IPR512 | GPRS / IP Monitoring Receiver

- For compatibility see www.paradox.com
- High-speed supervision for up to 512 Paradox control panels using IP or GPRS communication. Every communication module can report each partition with a unique account number.
- End-to-End Supervision: the entire communication line (control panel, receiver, and automation software) is fully supervised and can be reported due to Paradox's proprietary encrypted communication.
- Up to 32 security profiles can be created per receiver with a programmable Module Polling Time and Receiver Supervision Time (seconds, minutes, or hours).
- All reports are transmitted directly to the receiver from the IP or GPRS modules without having to use intermediary servers or network operation centers.
- Redundant Internet Service Provider (ISP): 2 Ethernet ports (WAN1 and WAN2) to receive events through two different ISPs.
- 2 Serial Ports: COM1 connects to Automation Software (used by monitoring station). COM2 connects to a serial printer or a PC with an RS232 serial communication software view/print events in plain text format.
- Integrated Account Management Web Page: access web page via LAN port to view, edit, and delete GPRS/IP modules, edit security profiles, configure receiver, view receiver troubles, and program special event report codes.
- Data backup on external memory card allows fast and easy substitution of receiver units in crash recovery situations. Uses external SD, SD/HC, or MMC memory cards.
- Firmware upgradeable in less than 90 seconds.
- Supports CID and SIA reporting format
- 128-bit (MD5 and RC4) or 256-bit AES data encryption
- Supports 19" rack mounting (1U) or desktop installation
- Automatic date and time synchronization via Network Time Protocol (NTP)
- Standard 110/220Vac power supply
- Extremely low noise and low power consumption (less than 10W)
- Secure private operating system
- Supported communication protocols for event reporting to the monitoring station's automation software include ADEMCO 685*, SURGARD MLR2-DG*, and RADIONICS 6500*

*ADEMCO 685, SURGARD MLR2-DG, and RADIONICS 6500 are trademarks of their respective companies.



PCS200



PCS200 | GPRS / GSM Communicator Module

- For compatibility see www.paradox.com
- Report events to the IPR512 GPRS/IP Monitoring Receiver via GPRS
- Fast Upload/download with WinLoad or NEware via a GPRS connection at data rates of up to 38.8 Kbit/s
- Firmware upgrade via GPRS or directly on-site
- Report via text message. Select which event groups will send SMS messages to up to 16 cell phones. Each text message contains event description, site name, date, time, and any associated labels, such as area, zone and serial number. Event descriptions are pre-defined in the PCS200 module and are available in multiple languages (installer selectable).
- Control panel communication supervision. When detected, the control panel will generate a trouble as well as report it to the monitoring station through a land line.
- Simple installation with a 4-wire serial connection
- Module antenna can be installed up to 18m (60ft) from the module using optional antenna cable extensions depending on the local signal strength
- 128-bit (MD5) and 256-bit (AES) encryption
- Available Q2 - Report events to the IPR512 GPRS/IP Monitoring Receiver via GSM
- Available Q2 - End users can arm or disarm the system by sending a text message (SMS) to the PCS200
- Available Q2 - Voice reporting. Use of the Paradox Plug-In Voice Module (VDMP3) to send pre-recorded voice messages to up to 8 phone numbers to report alarms. For more information on the VDMP3 see page 15.



EXT | Antenna Extensions

- Improve reception by relocating the antenna
- Includes wall mounting bracket
- Cables are available in 6ft, 12ft, 24ft, 48ft, and 60ft lengths



IP100 | Internet Module

- For compatibility see www.paradox.com
- Report events to the Paradox IPR512 GPRS/IP Monitoring Receiver via IP
- Control and monitor a control panel through an IP network (LAN/WAN/Internet)
- Use NEware or WinLoad to access your system through the Internet
- Receive notification of system alarms via email
- Arm/disarm individual partitions via web browser
- View live status of all zones and partitions (i.e. open/close, arm/disarm, troubles and alarms) via web browser
- Upgrade the firmware of the IP100 using the IP Exploring Tools through the Internet
- DNS service available for dynamic IP address
- Supports SMTP and ESMTP e-mail services (TLS/SSL not supported)
- Very low bandwidth consumption
- Data sent and received using 128-bit (MD5 and RC4) and 256-bit (AES) data encryption
- Two-way dynamic authentication
- Available in multiple languages



VDMP3 | Plug-In Voice Module

- For compatibility see www.paradox.com
- **Record a 15 second Site ID to identify the installation site**
- Dial up to 8 telephone numbers to report a burglar, panic or fire alarm using pre-recorded voice messages
- Arm/disarm the system and receive status reports remotely via telephone
- Control PGMs and toggle utility keys remotely via telephone
- Voice-guided menu
- Connects directly onto the control panel or PCS module (see page 14)
- Available in multiple languages



VD710 | ParaVox Voice Dialer

- For compatibility see www.paradox.com
- Local and remote telephone programming
- Provides any control panel with remote voice and pager messaging
- 4 zone inputs and 2 PGM outputs
- 4 telephone and 4 pager numbers
- 1 installer and 4 user PINs
- Voice message length: 4 x 15 seconds or 2 x 30 seconds
- In-field firmware upgradeable via 307USB and WinLoad
- Available in multiple languages



EVO192: 8 to 192 Zone Control Panel
EVO48: 8 to 48 Zone Control Panel

MULTIBUS
4-Wire
MULTIBUS



K07C

Keypads

- K07C: Grafica Color LCD Keypad
- K641: 32 Character Blue LCD Keypad
- K641R: 32 Character Blue LCD Keypad with Integrated Card Reader
- K648: 48 Zone LED Keypad
- ANC1: Annunciator Module



DG85

Motion Detectors

- DM50: Dual Element Motion Detector
- DM60: Quad Element Motion Detector
- DM70: Digital Dual-Optic High-Performance PIR
- DG85: Outdoor Digital Dual-Optic High-Performance PIR
- DG467: 360° Digital Ceiling Mounted PIR
- DG457: Digital GlassBreak Detector



PCS Series GPRS / GSM Communicator Modules

- Report via GPRS with Paradox IP Monitoring Receiver (IPR512)
- Upload/download with WinLoad via GPRS
- Report via GSM
- Send and receive SMS messages
- Connect directly to panel via 4-pin port



IP100 Internet Module

- Report via IP with Paradox IP Monitoring Receiver (IPR512)
- Send e-mails
- Control and monitor via web browser
- Connect directly to panel via 4-pin port



VDMP3 Plug-In Voice Module

- Send voice messages (8 phone numbers)
- Control and monitor via phone
- Mount on control panel or PCS module

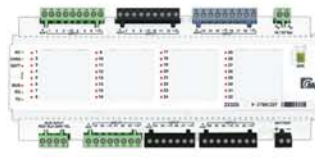

ZX32D

Zone Expansion

- ZC1: Door Contact Module
- ZX1: 1 Zone Expansion Module
- ZX4: 4 Zone Expansion Module
- ZX8D: 8 Zone Expansion Module
- ZX16D: 16 Zone Expansion Module
- ZX32D: 32 Zone Expansion Module
- RTX3: Wireless Expansion Module

Access Control



ACM12



R915

4-Wire Readers*

- ACM12: 4-Wire Access Control Module
- R910: 4 Wire Epoxy-Sealed Reader
- R915: 4 Wire Sealed Reader & Keypad

Other Wiegand Readers + Cards Available

Accessories



HUB4D: 4 Port Hub and Bus Isolator module

- PMC5: Memory Key
- 307USB: Direct Connect Interface
- CV4USB: RS-485/RS-232 Converter
- HUB2: 2 Port Hub
- NEware: End-User Software
- WinLoad: Installer Software



SUB1

Special Accessories

- LSN4: Listen-In Module
- SUB1: Listen-In Substation
- PGM4: 4-PGM Expansion Module
- PRT3: Integration Module
- PS17: 1.7A Power Supply Module
- PS27D: 2.85A Power Supply Module
- PS100D: Switching Power Supply

Digiplex EVO High Security and Access Systems

Digiplex EVO systems provide the highest level of protection for banks, high-security military and government sites, luxurious residential homes and any place where maximum security is essential. These systems are designed to be easy to use and the modular concept of these systems provides installers with labour-saving features that make expanding, installing and servicing these systems quick and convenient.

Expand your system by adding plug-and-play expansion modules anywhere and in any combination on the 4 wire combus. Modules are connected to the combus at the most convenient location and then their zone inputs are assigned to the desired zone and partition. Also, only a module's used inputs are assigned to zones in the system. Keyswitches, remote controls and unused module inputs do not use up zones. Once installed, all combus modules, including motion detectors, can be programmed remotely via a keypad or the WinLoad Installer Upload/Download software.

Digiplex EVO integrate access control solutions. Your alarm system user database can be used to manage the access to up to 32 doors, and the monitoring of these doors can be included in any partitions. You can also use Winload and NEware to manage users and access permissions. By merging security and access control, the Digiplex EVO increases the level of protection offered by security systems to a new level.

Feature	EVO48	EVO192
Maximum Zones*	48	192
On-Board Zones	8 (16 with ATZ)	8 (16 with ATZ)
Partitions	4	8
User Codes	96	999
Multibus	-	✓
Panel In-Field Firmware Upgradeable	✓	✓
Access Control (doors)	32 3	2
Access Levels / Schedules	16 / 32	16 / 32
Events Buffered	1024	2048
PGMs	250 (2 on board)	250 (5 on board)
PGM +/- trigger	✓	✓
Virtual Zones †	32	32
Expansion Modules*	127	254
GPRS/GSM Communication (PCS Series) See page 14	✓	✓
Supports VDMP3 (Plug-in Voice Module) See page 15	✓	✓
Supports IP100 (Internet Module) See page 14	✓	✓
Software	WinLoad / NEware	WinLoad / NEware
Listen-In Capabilities	✓	✓

* Can be any combination of hardwire, wireless or addressable zones or modules

† Automate PGM activations without occupying security zones

Control Panels



EVO48 | Digiplex EVO 48 Zone Control Panel

- 8 on-board zones (16 w/ zone doubling) expandable to 48 zones via 4 wire combus
- Built-in access control features
- Supports GPRS and GSM Module (PCS Series), IP Module (IP100) and Voice Module (VDMP3). See "Communication Modules" on page 13.
- In-field firmware upgradeable via 307USB and WinLoad
- Compatible with NEware V4.0 or higher
- V2.10 supports REM3
- Automatic Daylight Savings Time feature
- 2 on-board solid-state PGM outputs (+ 3 optional), negative or positive triggering
- PGM1 can be used as a 2 wire smoke input
- Supports up to 127 expansion bus modules
- 96 user codes
- 4 partitions
- 1024 events buffered
- Program remote controls using the master or installer codes
- Up to 96 remote controls with one RTX3
- Built-in real-time clock backup battery
- 1.7A switching power supply
- 1 supervised bell output, auxiliary output and telephone line
- Patented 2 opto coupler dialer circuit - the most reliable dialer in the industry (US Patents 5751803, RE39406)
- Push button software reset (reset to default values and restart)
- Push button to activate or deactivate the Auxiliary output
- Fits in a 28cm x 28cm x 7.6cm (11in x 11in x 3in) metal box
- The EVO series share the same programming for easy panel substitution



EVO192 | Digiplex EVO 192 Zone Control Panel

Same features as the EVO48 plus:

- Expandable to 192 zones
- 5 on-board solid-state PGM outputs, negative or positive triggering
- Supports up to 254 expansion bus modules
- 999 user codes
- 8 partitions
- 2048 events buffered
- Up to 999 remote controls with one RTX3

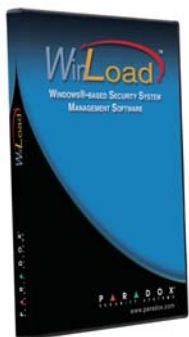

UDS | WinLoad Installer Upload/Download Software

- Connect to WinLoad via a GPRS connection at data rates of up to 48Kbit/s with a PCS module
- Supports TCP/IP connections through the IP100
- User-friendly programming and monitoring of the Digiplex EVO, Magellan, Spectra SP Series and E55/65 control panels and modules
- Remote uploading and downloading using most standard modems at 300 baud
- On-site (local) uploading and downloading at 57.6k baud (Magellan console), 38.4k baud (EVO) or 9.6k baud (E55/65, MG5000, MG5050 and Spectra SP) using a 307USB Direct Connect Interface (60m/200ft) or a CV4USB Converter (300m/1000ft)
- In-field upgrading feature that allows WinLoad to upgrade the firmware of certain control panels/modules via a 307USB interface or a CV4USB converter
- Multiple users, groups, and databases
- Network-compatible database
- Advanced printing of reports and zone/user programming
- Supports several languages simultaneously (available in English, Spanish, Chinese, Czech, French, Hebrew, Hungarian, Italian, Polish, Portuguese, Russian, Serbo-Croatian, Slovak, Swedish and Turkish)



NEWare End-User Management Software

NEWDEM (Demo Edition)

NEWSEC (Security Edition)

NEWACC (Security and Access Control Edition)

- Now supports TCP/IP connections through the IP100
- Program access codes and settings of all users in a EVO48 or EVO192 system
- Live system monitoring (view system and zone status and troubles) without interrupting central station communication or system operation
- Draw and download/upload up to 32 floor plans for Grafica (see page 19)
- Download images and tunes into Grafica (see page 19) for special events
- Arm/disarm, bypass zones, and control PGMs
- Search, sort and filter saved system events
- Generate and print customized reports
- Download floor plans, tunes, graphics, and screen savers into Grafica
- On-site (local) uploading and downloading at 38.4k baud (EVO) using a 307USB Direct Connect Interface (60m/200ft) or a CV4USB Converter (300m/1000ft)
- Supports several languages simultaneously

Keypad and Display Modules

Features Common to All Digiplex Keypads

- Zone alarm display: the zones in alarm are shown until the system is disarmed
- Connects to 4-wire combus
- Assign to one or more partitions
- 1 addressable zone
- 1 PGM output*
- Independently set chime zones
- 14 one-touch action buttons*
- 3 keypad-activated panic alarms

*Except K07C



K07C | 32-Partition Grafica Color LCD Keypad

- See full description on page 10



K641 | 32 Character Blue LCD Keypad

- Compatible with Digiplex EVO
- In-field firmware upgradeable via a CV4USB and WinLoad
- Simplified end-user remote control programming
- 32-character blue LCD with programmable labels (via Memory Key, Winload, NEWare or Module Broadcast feature)
- Available in Croatian, Czech, English, French, German, Greek, Hebrew, Hungarian, Italian, Polish, Portuguese, Russian, Spanish, Swedish, and Turkish
- Adjustable backlight, contrast, and scroll speed
- Display time using the 12Hr or 24Hr format
- See Features Common to All Digiplex Keypads on page 19



K641R | 32 Character Blue LCD Keypad with Integrated Card Reader

Same features as the K641 plus:

- Built-in card reader. Just present access cards directly to the keypad
- Grant access via card and/or access code
- Arm and disarm with a card
- Door contact and request for exit inputs
- Door lock output
- Programmable automatic unlocking schedule
- Door Left Open and Door Forced Open alarms



K648 | 48 Zone LED Keypad

- 48-zone LED display (each LED can be set to display any zone number from 1 to 96)
- 4-partition LED display (each LED can be set to display any partition from 1 to 8)
- See Features Common to All Digiplex Keypads on page 19



ANC1 | Annunciator Module

- Zone alarm display: the zones in alarm will flash until they are disarmed
- LED display shows the status of either partitions 1-8, zones 1-48, or zones 49-96
- 3-in-1 product (comes with three different display labels)
- Mount as a stand-alone unit or over any LCD or LED keypad
- Stack up to three annunciators
- Assign to one or more partitions

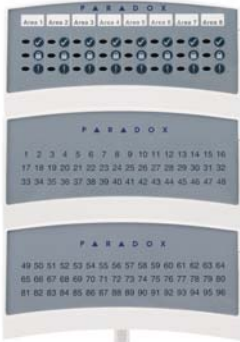

Motion Detector Modules



Features Common to All Digiplex Motion Detector Modules

- Patented Digital Motion Detection (no analog circuitry)*
- Patented Auto Pulse Signal Processing
- Digital Shield algorithm software
- Automatic temperature compensation
- Single or dual edge processing
- Connect to the Digiplex EVO 4 wire bus directly
- Metal shield maximizes protection from EMI and RFI signals*
*except DG467

DM50 | Dual Element Motion Detector Module DM60 | Quad Element Motion Detector Module

- 12m x 12m (40ft x 40ft) range with 110° viewing angle
- Digital Dual Opposed Detection (DM60 only)
- Interlock Sensor Geometry (ISG) (DM60 only)
- See Features Common to All Digiplex Motion Detector Modules on page 20

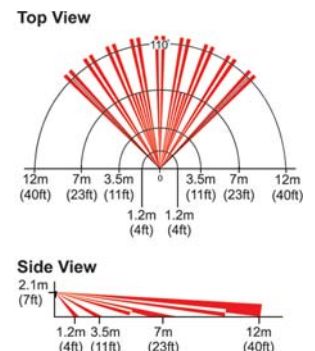

DIGI PLEX EVO



DM70 | Digital Dual-Optic High-Performance PIR Module (40kg/90lb Pet Immunity)

Same features as the DM50, plus:

- Dual optics (2 dual opposed element sensors)
- Provides superior pet immunity using a patented combination of advanced optics and digital processing technologies
- Immune to pets weighing up to 40kg (90lb)
- Extremely reliable and false-alarm free
- 11m x 11m (35ft x 35ft) range with 90° viewing angle
- See Features Common to All Digiplex Motion Detector Modules on page 20

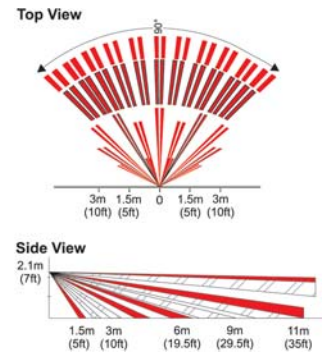

DG85 | Outdoor Digital Dual-Optic High-Performance PIR Module

Same features as the DG75 (page 50) plus a special weatherproof design:

- The DG85 series is available with one of three lenses (see page 53 for more details): Pet Array, Horizontal Curtain Beam or Vertical Curtain Beam.
- Impact and temperature resistant casing
- Operates at -35°C to +50°C (-31°F to +122°F)
- Casing lined with an injected rubber gasket
- UV protected lens
- Dual Optical Filtering System
- Multi-level sensitivity adjustment
- Two operational modes (addressable for EVO or conventional relay operation)
- Can be used with the Heavy Duty Outdoor Swivel Bracket (SB85).
- See Features Common to All Digiplex Motion Detector Modules on page 20



DG467 | 360° Digital Ceiling Mounted Motion Detector Module

- Digital Motion Detection
- Dual element sensor
- 7m x 6m (24ft x 20ft) at 2.4m (8ft)
- 11m x 6m (35ft x 20ft) at 3.7m (12ft)
- 360° viewing angle
- Solid-state relay
- Anti-tamper switch
- Two operational modes (addressable for the EVO series or conventional relay operation)
- See Features Common to All Digiplex Motion Detector Modules on page 20

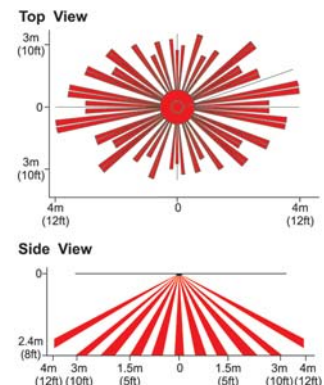

DG457 | Digital Glassbreak Bus Detector

- Two operational modes (addressable for the EVO series or conventional relay operation)
- Remote test mode when used with TestTrek V2
- Full audio and infrasonic spectrum analysis
- 7 frequency digital filters, digital amplifier gain and frequency fluctuation assessment
- Impact and shock wave analysis
- High-immunity to RFI and EMI signals
- Adjustable sensitivity: covers up to 9m (30ft) when set to high and up to 4.5m (15ft) when set to low
- TestTrek (459 V2.0) used for testing available separately (see page 52)
- Anti-tamper switch

Signal Envelope Analysis

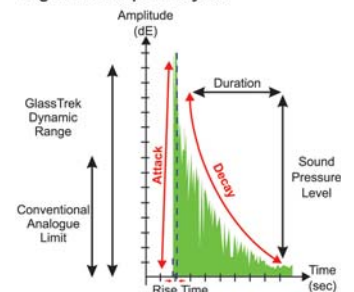

Hardwired Zone Expansion Modules

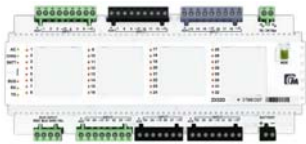

- ZX32D | 32 Zone Expansion Module with 2.85A Power Supply**
- See full description on page 7



- ZX16D | 16 Zone Expansion Module**
- See full description on page 8

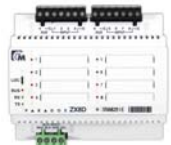

- ZX8D | 8 Zone Expansion Module**
- See full description on page 8



- ZC1 | Door Contact Module**
- 1 addressable zone
 - Small size: 7.4cm x 2.0cm x 3.5cm (2.9in x 0.8in x 1.2in)



- ZX1 | 1 Zone Expansion Module**
- 1 addressable zone (2 with ATZ zone doubling feature)
 - Set a different input speed for each zone (up to 255 minutes), which is ideal for temperature monitoring applications



- ZX4 | 4 Zone Expansion Module**
- 4 addressable zones (8 with ATZ zone doubling feature)
 - Set a different input speed for each zone (up to 255 minutes); ideal for temperature monitoring applications
 - Use zone input as an anti-tamper switch input



- ZX8 | 8 Zone Expansion Module**
- Compatible with Spectra SP series, E55/65, MG5000, MG5050 and Digiplex/EVO
 - 8 addressable zones (16 with ATZ zone doubling feature)
 - Set a different input speed for each zone (up to 255 minutes), which is ideal for temperature monitoring applications
 - 1 PGM output
 - Use zone input as an anti-tamper switch input

Wireless Expansion Module



- RTX3 | Wireless Expansion Module**
- See full description on page 8

Listen-In Modules



LSN4 | Listen-In Module

- Audio alarm verification (listen-in or two-way communication)
- “Before and after” alarm audio recording and playback
- Message broadcasting (play system status messages through substations)
- Customize or record broadcasted messages
- Remote telephone access (listen-in/two-way, arm/disarm and system status)
- Communicate or listen to a specific substation
- Toggle between high and low gain on speakers and microphones
- Remotely activate or deactivate the siren
- In-field firmware upgradeable via 307USB and WinLoad
- Connect to a music source to play background music through substations
- Supports 4 primary SUB1 substations (fully functional)
- Supports 8 secondary SUB1 substations (used as additional speakers)



SUB1 | Listen-In Substation

- Unique substation design
- 16 bit sound quality (built-in 7.6cm (3.0in), 3W 8Ω speaker)
- Built-in high-sensitivity microphone
- Page button (communicate with monitoring station and/or other substations)
- Panic button (send panic signal to monitoring station)
- Mute button (mute broadcasted messages and background music)
- Volume control knob
- Simple CAT-5 cable connection to a LSN4 Listen-In Module

Access Control Modules



ACM12 | 4 Wire Access Control Module

- Grant access via card and/or panel access code with the R915
- Arm with card and pin with the R915
- Connections for 1 door (card reader, REX, door contact and lock output)
- Connect only 4 wires between the reader and ACM12 module when using a R910 or a R915 reader
- In-field firmware upgradeable via CV4USB and WinLoad
- Automatic unlocking schedule
- Door Left Open and Door Forced Open options
- Door unlock and extended delay timers
- Unlock door manually with button or PGM event
- Unlock Door On Fire Alarm option
- Safe Mode option (during a communication loss, the access control door connected to the module can grant access to up to 4 specified cards or any valid cards)
- Built-in supervised 1.5A switching power supply
- Push button to activate or deactivate the Auxiliary output
- Supports 4 wire and 26 bit Wiegand card readers
- Fits in a 20cm x 25.5cm x 7.6cm (8in x 10in x 3in) metal box



R910 | 4 Wire Epoxy-Sealed Indoor/Outdoor Proximity Reader

- See full description on page 6



R915 | 4 Wire Sealed Indoor/Outdoor Proximity Reader and Keypad

- See full description on page 6



R870-A | Indoor Proximity Reader

- Indoor installation only
- Covers single gang box
- Screw terminals
- Two status LEDs (red and green) and beeper
- Supports the 26 bit Wiegand output format



R890-BL | Indoor/Outdoor Extended Range Proximity Reader

- Extreme weather-resistant design (epoxy sealed)
- Up to 61cm (24in) read range with C702 access card
- Automatic read-range calibration
- Supports the 26 bit Wiegand output format
- Tricolor LED display
- Elegant face light



Proximity Cards

- **C702:** Clam Shell Card
- **C706:** 2 Sided High-Gloss ISO Card
- **C704/S:** Blue Proximity Key Tag
- **RAC1:** Magellan Remote Control with Integrated Access Card
- **RAC2:** Magellan Two-Way Remote Control with Integrated Access Card

Power and Hub Modules



PS27D | 4-Output 2.85A Power Supply Module

- See full description on page 7



PS100D

- See full description on page 7



PS17 | Power Supply Module

- 1.7A switching power supply
- Fully supervised (AC, battery, low battery and auxiliary limit)
- Selectable battery charge current (350mA/850mA)
- 1 PGM output
- Includes 20cm x 25.5cm x 7.6cm (8in x 10in x 3in) metal box

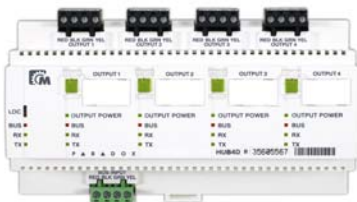

HUB4D | 4 Port Hub and Bus Isolator Module

- Divides the bus into four completely isolated outputs (if one output fails, the others will continue to function)
- One input port, 4 completely isolated output ports
- Each output port provides communications up to 900m (3000ft)
- Opto-isolated ports provide protection from high-voltage spikes (ideal for exterior lines)
- In-field firmware upgradeable
- DIN rail enclosure with removable terminals
- Supports 35mm DIN Rail mounting or wall mounting with retractable mounting clips
- On-board buttons to manually activate or deactivate each hub output
- 4 LED status display per hub output
- 3 LED module status display
- Includes labels to identify each output



HUB2 | 2 Port Hub and Bus Isolator

- Divide the communication bus into multiple completely isolated outputs (if one output fails, the others will continue to function)
- One input port, 2 completely isolated output ports
- Each output port provides communications up to 900m (3000ft)
- Compatible with E55/65, MG5000, MG5050, Spectra SP Series and Digiplex EVO

Special Modules



PGM4 | 4 PGM Expansion Module

- Current version is compatible with E55/E65 (V2.00), Digiplex EVO, V3.0 will also be compatible with MG5000, MG5050 and Spectra SP
- In-field firmware upgradeable via a CV4USB or 307USB and WinLoad (PGM4 V3.0)
- 4 programmable 5A relay outputs
- Deactivate PGM after event or timer
- Pulse PGM output for fire alarms
- Will replace currently available PGM4



PRT3 | Integration Module

- In-field firmware upgradeable via CV4USB and WinLoad
- Supports ASCII / C-BUS protocols
- 16 virtual inputs to trigger an action in the EVO control panel based on an event received from the peripheral system using ASCII or C-BUS protocol
- 30 virtual PGMs to trigger an action in the peripheral system using ASCII or C-BUS protocol based on an event received from the EVO control panel
- USB port for PC connections
- Provides an interface between an EVO control panel and a third party peripheral system
- Automatically/manually print reports of zones/systems event via printer and/or PC
- Parallel and serial port for printer connections
- Assign to one or more partitions
- 2048 event buffer
- Available in multiple languages

System Accessories



Q1 2009

DB608D | DIN Metal Box with Plexiglass Door

- See full description on page 12



PMC5 | Hand-Held Plug-in USB Memory Key

- Includes USB connector to download or upload system programming to or from a PC with WinLoad
- Lock switch to prevent accidental loss of data
- LED status indication
- Download or upload control panel/console programming within seconds
- Connect directly to memory connector on the control panel/console
- No need for a telephone line, PC or any other peripheral device



307USB | Direct Connect Interface

- Includes 3 LED status indicators (PC, Panel and RX/TX)
- Incorporates a USB port and a serial port (DB-9)
- Enables control panel to communicate with a PC at 60m (200ft)
- Connect between panel's serial port connector to a PC's serial (DB-9) or USB port
- 57.6k baud communication (Magellan console), 38.4k baud communication (EVO) or 9.6k baud communication (E55/65, MG5000, MG5050 and Spectra SP)



CV4USB | RS-485/RS-232 Converter Kit

- Incorporates a USB port and a serial port (DB-9)
- Enables control panel to communicate with a PC at 300m (1000ft)
- Connect from the control panel's serial port connector to PC's serial port (DB-9) or USB port
- 38.4k or 57.6k baud communication (EVO)



UIP256 | Universal In-Field Programmer

- Upgrade Magellan console and Grafica (V1.21 to 1.4) firmware locally in the field
- Includes proprietary PC software, cables to interconnect a Magellan console or a Grafica keypad and a PC, and two 9V batteries
- The supplied PC software retrieves the latest Magellan or Grafica update file (firmware) from our website and then updates the Magellan console or the Grafica keypad



TEMP07 | Temperature Sensor

- Connects to the Grafica's zone/temperature input to measure the external temperature
- Maximum distance from the Grafica: 30.5m (100ft)

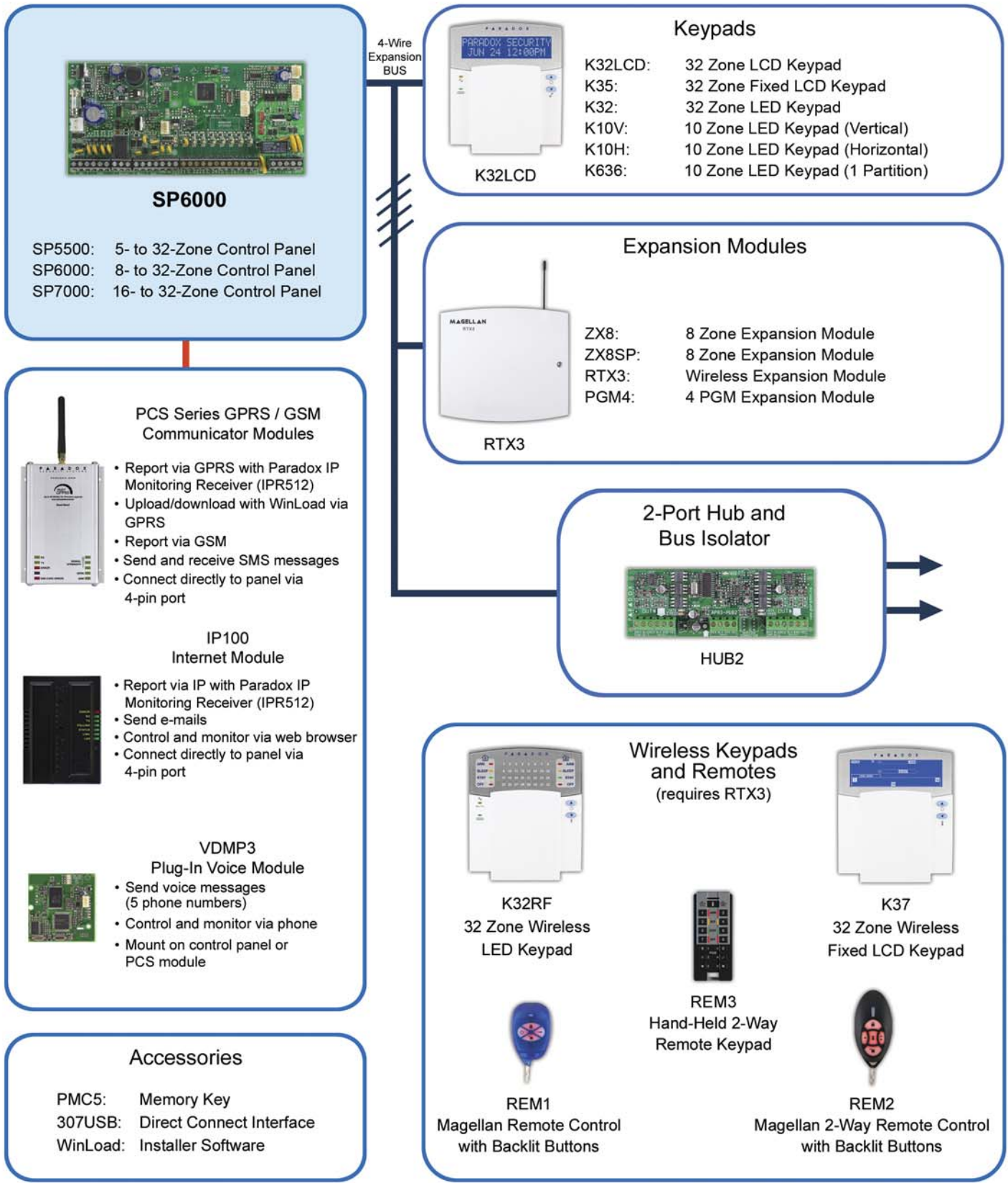



Spectra SP Expandable Security Systems

Spectra SP offers a combination of innovative features and an advanced communication bus for a unique expandable security system. Through its communication bus, Spectra SP can be expanded via wireless and hardwired expansion modules and a variety of accessory modules. With its reliable communication technology, flexible expansion and great-looking keypads, Spectra SP is an ideal security system for any residential or commercial installations that require up to 32 zones of protection.

Spectra SP is StayD-enabled, which provides a heightened level of security that ensures that the system is always armed, never disarmed. The panels also offer more on-board zones (expandable to 32), more on-board PGMs (expandable to 16), and support for the new Plug-In Voice Module (VDMP3) and Internet Module (IP100).

With their in-field firmware upgrade capability, the Spectra SP series allows installers to upgrade their system without hassle - quickly, easily and on site. And to further facilitate installation, every Spectra SP series panel can be configured using easy-to-follow menu-driven programming.

Feature	SP5500	SP6000	SP7000
StayD	✓	✓	✓
Maximum Zones	32*	32*	32*
On-board Zones	5 (10 with ATZ)	8 (16 with ATZ)	16 (32 with ATZ)
Expansion Zones	24	24	16
Keypad Zones	15	15	15
Partitions	2	2	2
User Codes	32	32	32
PGMs	16* (2 on-board)	16* (2+2† on-board)	16* (4 on-board)
PGM +/- Trigger	-	✓	✓
Alarm Relay	-	1†	1
Event Buffer	256	256	256
Remote Control	32	32	32
Wireless Keypads (K32RF and K37)	8	8	8
Wireless Repeater (RPT1)	2	2	2
Wireless Siren (SR150) See page 47	4	4	4
Wireless Expansion (RTX3)	✓	✓	✓
2 Wire Smoke Detector Input	-	✓	✓
GPRS/GSM Communication (PCS Series) See page 14	✓	✓	✓
Internet TCP/IP Communication (IP100) See page 15	✓	✓	✓
Plug-In Voice Module (VDMP3) See page 14	✓	✓	✓
In-field Firmware Upgradeable	✓	✓	✓

* = Any of which can be wireless

† = Optional

Control Panels



STAY D

SP5500 | 5 to 32 Zone Control Panel

- StayD mode: see inside cover for details
- 4 wire expansion bus (connect up to 15 keypads and up to three ZX8/ZX8SP modules to a maximum total of 15 modules)
- 5 zone inputs or 10 with zone doubling, expandable to 32 zones
- 2 on-board PGMs
- Supports up to 16 PGMs
- 2 partitions
- 32 User Codes
- Supports GPRS and GSM Module (PCS Series), IP Module (IP100) and Voice Module (VDMP3). See "Communication Modules" on page 13.
- Supports REM3 hand-held remote keypad (require RTX3 V1.31 or higher)
- 1.1A switching power supply
- In-field firmware upgradeable via a 307USB and WinLoad
- Menu-driven programming for the Installer, Master and Maintenance codes
- Phone #: 3 for monitoring station, 5 for personal dialing and 1 for pager reporting
- Patented 2 opto coupler dialer circuit - the most reliable dialer in the industry (US Patents 5751803, RE39406)
- Automatic Daylight Savings Time feature
- Push button software reset (reset to default values and restart)
- Direct connect at 9.6k baud with WinLoad
- 256 events buffered
- Fits in 20cm x 25.5cm x 7.6cm (8in x 10in x 3in) and 28cm x 28cm x 7.6cm (11in x 11in x 3in) metal boxes



STAY D

SP6000 | 8 to 32 Zone Control Panel

Same features as the SP5500 plus:

- 8 zone inputs or 16 with zone doubling, expandable to 32 zones
- 2 (+2 optional) on-board PGM outputs, positive or negative triggering
- 1 alarm relay (optional)
- 1.5A switching power supply



STAY D

SP7000 | 16 to 32 Zone Control Panel

Same features as the SP6000 plus:

- 16 zone inputs or 32 with zone doubling, expandable to 32 zones
- 4 on-board PGM outputs, positive or negative triggering
- 1 alarm relay



UDS | WinLoad Installer Upload/Download Software

- See full description on page 18

Hardwired Keypads

Features Common to All Hardwired Keypads

- Supports StayD
 - 1 keypad zone input
 - 8 one-touch action buttons
 - Independently set chime zones
 - 3 keypad-activated panic alarms
 - Connects to 4 wire expansion bus
 - Compatible with E55/65*, MG5000, MG5050 and Spectra SP Series
- *Except K32LCD



STAY D

K32LCD | 32 Character Hardwired LCD Keypad

- 32 character blue LCD with programmable labels
- Real-time zone alarm display (until disarmed)
- Menu-driven programming for easy system setup (installer and end user)
- StayD status LED
- In-field firmware upgradeable via a 307USB and WinLoad
- Adjustable backlight, contrast and scroll speed
- 2 partition keypad
- See Features Common to All Hardwired Keypads on page 29



STAY D

K35 | 32 Zone Hardwired Fixed LCD Keypad

- Fixed message display that guides you in the operation of the system
- Displays the status of 32 zones in 2 partitions
- StayD status icon
- In-field firmware upgradeable via a 307USB and WinLoad
- Displays Arm, Sleep, Stay and Disarmed status for each partition
- Displays troubles, bypassed zones and alarm memory
- Adjustable backlight
- 2 partition keypad
- See Features Common to All Hardwired Keypads on page 29



STAY D

K32 | 32 Zone Hardwired LED Keypad

- 32 zone LED display
- StayD status icon
- In-field firmware upgradeable via a 307USB and WinLoad
- Separate Arm, Sleep, Stay and Off LEDs per partition
- Adjustable backlight
- 2 partition keypad
- See Features Common to All Hardwired Keypads on page 29



K10V

STAY D

K10V | 10 Zone Hardwired LED Keypad (Vertical)

K10H | 10 Zone Hardwired LED Keypad (Horizontal)

- 10 zone LED display
- StayD status LED
- Separate Arm, Sleep, Stay and Off LEDs per partition
- Patented Key Light display (button lights up to indicate an open zone)
- Adjustable backlight
- 2 partition keypad
- See Features Common to All Hardwired Keypads on page 29



K10H



K636 | 10 Zone Hardwired LED Keypad

- Single partition keypad
- 10 zone LED display
- StayD status LED
- Patented Key Light display (button lights up to indicate an open zone)
- Arm, Sleep, Stay and Off keys illuminate to indicate partition status
- Adjustable backlight
- See Features Common to All Hardwired Keypads on page 29

Hardwired and Wireless Expansion Modules



ZX8SP | 8 Zone Expansion Module

- ZX8SP is compatible with the Spectra SP series, E55/65, MG5000 and MG5050
- Add 8 zones
- 1 PGM output
- Use zone input as an anti-tamper switch input



ZX8 | 8 Zone Expansion Module

- See full description on page 22



RTX3 | Wireless Expansion Module

- See full description on page 8
- Supports SR150 Wireless Siren (see page 47)

System Accessories



PGM4 | 4 PGM Expansion Module

- See full description on page 25



HUB2 | 2 Port Hub and Bus Isolator

- See full description on page 25



PMC5 | Hand-Held Plug-in USB Memory Key

- See full description on page 26



307USB | Direct Connect Interface

- See full description on page 26

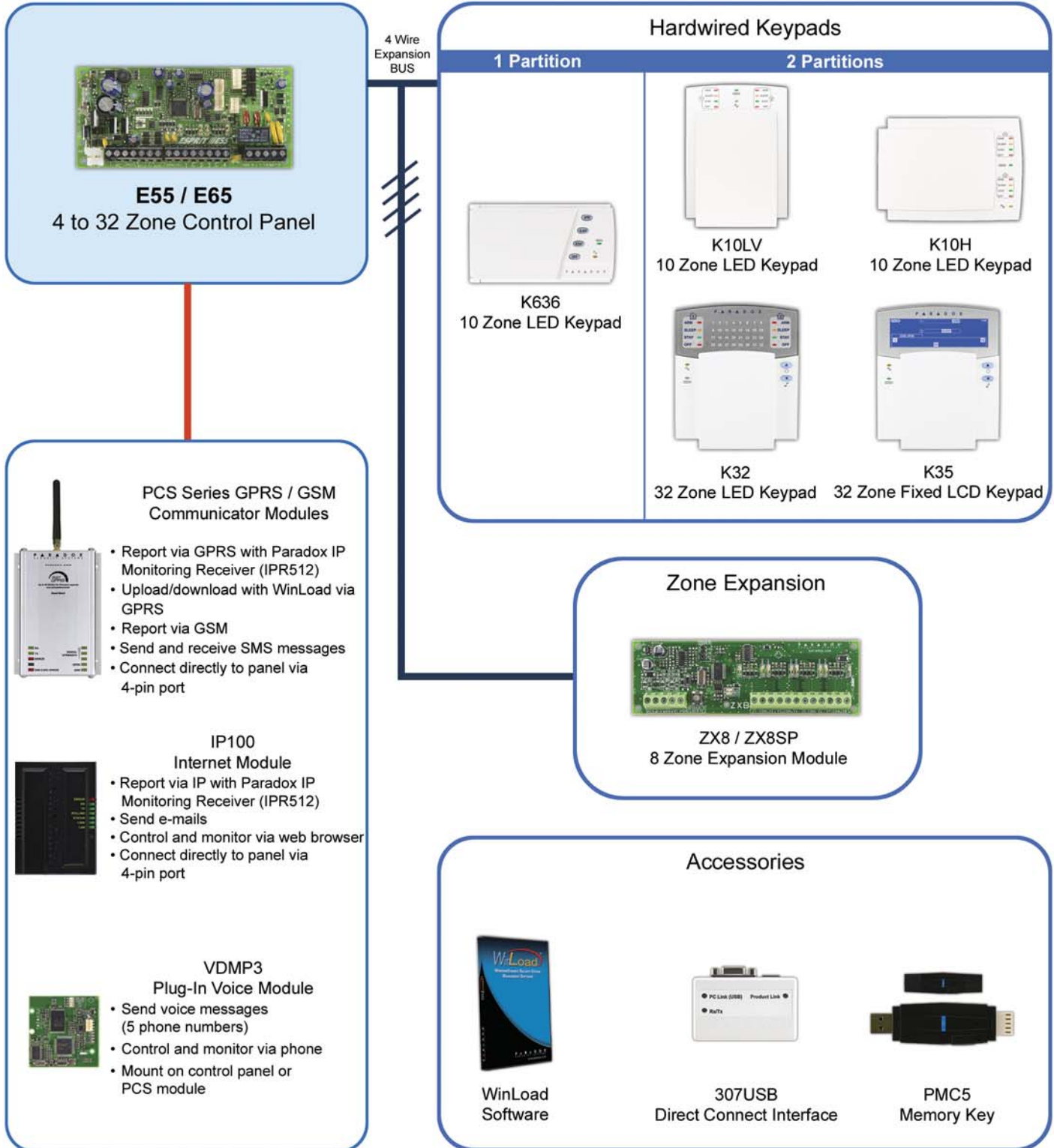

E55 / E65
4 to 32 Zone Control Panel



4 Wire Expansion BUS

Hardwired Keypads

1 Partition

2 Partitions



K636
10 Zone LED Keypad



K10LV
10 Zone LED Keypad



K10H
10 Zone LED Keypad



K32
32 Zone LED Keypad



K35
32 Zone Fixed LCD Keypad

PCS Series GPRS / GSM Communicator Modules



- Report via GPRS with Paradox IP Monitoring Receiver (IPR512)
- Upload/download with WinLoad via GPRS
- Report via GSM
- Send and receive SMS messages
- Connect directly to panel via 4-pin port

IP100 Internet Module



- Report via IP with Paradox IP Monitoring Receiver (IPR512)
- Send e-mails
- Control and monitor via web browser
- Connect directly to panel via 4-pin port

VDMP3 Plug-In Voice Module



- Send voice messages (5 phone numbers)
- Control and monitor via phone
- Mount on control panel or PCS module

Zone Expansion



ZX8 / ZX8SP
8 Zone Expansion Module

Accessories



WinLoad Software



307USB Direct Connect Interface



PMC5 Memory Key

Esprit E-Series Hardwired Security Systems

The new Esprit E55 and E65 control panels offer reliable, entry-level security that includes more features, such as StayD, support for GPRS, GSM, IP and voice, enhanced expansion (up to 32 zones), and in-field firmware upgradeability.

The Esprit E-Series is StayD-enabled, which provides a heightened level of security that ensures that the system is always armed, never disarmed. With the support of the PCS Series Communicator Modules, the new Esprit E-Series panels can report via GPRS, GSM, connect to WinLoad via GPRS, and notify you of system events by sending a text message. Furthermore, report via IP, receive system event notification through email with the IP100 Internet Module, and through voice messages with the VDMP3 Voice Module. Based on the Magellan and Spectra SP Series platform, the Esprit E-Series uses the same programming method for users and installers.

The Esprit E-Series provides the latest in security technology and a great value that is ideal for any residential or small business installation.

Security Features	E55 GPRS	E55 GSM	E65
• StayD	✓	✓	✓
• Maximum Zones	32	32	32
• On-Board Zones	4 (8 with ATZ)	4 (8 with ATZ)	9 (18 with ATZ)
• Keypad Zones	15	15	15
• Partitions (*1 partition with K636 keypad)	2*	2*	2*
• Users	32	32	32
• PGMs	1	1	3
• Events Buffered	256	256	256
• Pager Reporting	✓	✓	-
• GPRS/GSM Communication (PCS Series) See page 14	✓	-	✓
• IP Reporting (IP100) See page 15	✓	-	✓
• Email/Monitoring (IP100)	✓	✓	✓
• Voice and Utility Reporting (VDMP3) See page 14	✓	✓	Via GSM (PCS Series)
• In-field Firmware Upgrade	✓	✓	✓
• Upload / Download Software	WinLoad	WinLoad	WinLoad
• Patented 2 opto coupler dialer circuit (US Patents 5751803, RE39406)	✓	✓	-

Control Panels



E55 | 4- to 32-Zone Control Panel

- Supports StayD mode
- 4-wire expansion bus
- 4 on-board zones (8 with ATZ)
- Expandable to 32 zones
- 2 partitions (1 partition when used with K636 keypad)
- 32 user codes
- Supports GPRS and GSM Modules (PCS Series), IP Module (IP100) and Voice Module (VDMP3). See "Communication Modules" on page 13.
- 1 PGM output
- 1.1A switching power supply
- In-field firmware upgradeable via a 307USB and WinLoad
- Menu-driven programming for the Installer, Master and Maintenance codes
- Phone #s: 3 for monitoring station, 5 for personal dialing and 1 for pager reporting
- Direct connect at 9.6k baud with WinLoad
- 256 events buffered
- Fits in 20cm x 25.5cm x 7.6cm (8in x 10in x 3in) and 28cm x 28cm x 7.6cm (11in x 11in x 3in) metal boxes



E65 | 9- to 32-Zone Control Panel

Same features as the E55 plus:

- 9 on-board zones (18 with ATZ)
- 3 PGM outputs
- No landline dialer



UDS | WinLoad Installer Upload/Download Software

- See full description on page 18

Keypads



K636 | 10-Zone Hardwired LED Keypad

- See full description on page 30



K10V

K10H

K10V | 10-Zone Hardwired LED Keypad (Vertical)

K10H | 10-Zone Hardwired LED Keypad (Horizontal)

- See full description on page 30



K32 | 32-Zone Hardwired LED Keypad

- See full description on page 30



K35 | 32-Zone Hardwired Fixed LCD Keypad

- See full description on page 30

Zone Expansion Module



ZX8SP | 8-Zone Expansion Module

- See full description on page 31



ZX8 | 8-Zone Expansion Module

- See full description on page 22

System Accessories



PGM4 | 4 PGM Expansion Module

- See full description on page 25



PMC5 | Hand-Held Plug-in USB Memory Key

- See full description on page 26



307USB | Direct Connect Interface

- See full description on page 26



MG5000: 2 to 32 Zone Wireless Transceiver Control Panel

MG5050: 5 to 32 Zone Wireless Transceiver Control Panel

Wireless Keypads and Remotes



K37 K32RF REM3 REM2 REM1

Hardwired Keypads



K32LCD

- K32LCD: 32 Zone LCD Keypad
- K35: 32 Zone Fixed LCD Keypad
- K32: 32 Zone LED Keypad
- K10V: 10 Zone LED Keypad (Vertical)
- K10H: 10 Zone LED Keypad (Horizontal)
- K636: 10 Zone LED Keypad (1 Partition)

Expansion Modules



ZX8

- ZX8SP: 8 Zone Expansion Module
- ZX8: 8 Zone Expansion Module
- PGM4: 4 PGM Expansion Module

PCS Series GPRS / GSM Communicator Modules



- Report via GPRS with Paradox IP Monitoring Receiver (IPR512)
- Upload/download with WinLoad via GPRS
- Report via GSM
- Send and receive SMS messages
- Connect directly to panel via 4-pin port

IP100 Internet Module

- Report via IP with Paradox IP Monitoring Receiver (IPR512)
- Send e-mails
- Control and monitor via web browser
- Connect directly to panel via 4-pin port

VDMP3 Plug-In Voice Module

- Send voice messages (5 phone numbers)
- Control and monitor via phone
- Mount on control panel or PCS module

Wireless Devices



RPT1 2WPGM SD738

DCT10 DCTXP2 DCT2 SR150

PMD85 PMD75 PMD1P

Accessories

- PMC5: Memory Key
- 307USB: Direct Connect Interface
- WinLoad: Installer Software
- APR3-HUB2: 2 Port HUB

Magellan Wireless Transceiver Security Systems

The Magellan line of two-way wireless security systems provides you a combination of security, wireless convenience, easy installation and attractive customer features. Magellan is StayD-enabled, which provides a heightened level of security that ensures that the system is always armed, never disarmed. Also, the Magellan control panels can be expanded to provide you with more features, such as the new Plug-In Voice Module (VDMP3) and the TCP/IP Internet Module (IP100).

With their in-field firmware upgrade capability, Magellan control panels allow you to upgrade your system without hassle - quickly, easily and on site. And to further facilitate installation, every Magellan control panel can be configured using easy-to-follow menu-driven programming.

The features and benefits of the MG5000 and MG5050 make the Magellan line of wireless control panels ideal for any residential or small commercial installation requiring up to 32 zones of protection.

Security Features	MG5000	MG5050
• StayD	✓	✓
• Built-in Transceiver	✓	✓
• Maximum Zones*	32	32
• On-Board Hardwired Zones	2 (4 with ATZ)	5 (10 with ATZ)
• Expansion Zones (ZX8)	24	24
• Keypad Zones	15	15
• Partitions	2	2
• Users	32	32
• Remote Controls	32	32
• PGMs	16* (2 on-board)	16* (4 on-board)
• Events Buffered	256	256
• Wireless Keypads (K32RF and K37)	8	8
• Wireless Repeaters	2	2
• Expansion Bus	✓	✓
• GPRS/GSM Communication (PCS Series) See page 14	✓	✓
• Internet TCP/IP Communication (IP100) See page 14	✓	✓
• Voice and Utility Reporting (VDMP3) See page 15	✓	✓
• Wireless Siren (SR150) See page 47	✓	✓
• Personal Dialing	✓	✓
• Pager Reporting	✓	✓
• In-field Firmware Upgrade	✓	✓

* = Any of which can be wireless

Control Panels



MG5000 | Magellan 32-Zone Wireless Transceiver Control Panel

- StayD Mode
- Built-in transceiver (433MHz or 868MHz)
- 32 zones (any of which can be wireless)
- 32 users and 32 remote controls (one per user)
- 2 partitions
- 4-wire communication bus (connect up to 15 keypads)
- 2 on-board hardwired zone inputs (4 with ATZ)
- Supports REM3, eight K32RF / K37 wireless keypads, four SR150 wireless sirens (see page 47), and two RPT1 wireless repeaters
- Supports GPRS and GSM Module (PCS Series), IP Module (IP100) and Voice Module (VDMP3). See “Communication Modules” on page 13.
- Supports 16 PGMs (any of which can be wireless)
- 2 on-board PGM outputs
- In-field firmware upgrade via 307USB and WinLoad
- Menu-driven programming for the Installer, Master and Maintenance codes
- Phone #s: 3 monitoring, 5 for Personal Dialing and 1 for pager
- Patented 2 opto coupler dialer circuit - the most reliable dialer in the industry (US Patents 5751803, RE39406)
- Calendar with Daylight savings Time
- New Sleep arming method
- Push button power reset
- RF Jamming Supervision
- 9.6k baud communication with WinLoad
- 256 events buffered
- Fits in a 20cm x 25.5cm x 7.6cm (8in x 10in x 3in) metal box



MG5050 | Magellan 32-Zone Wireless Transceiver Control Panel

Same features as the MG 5000 plus:

- 5 on-board hardwired zone inputs (10 with ATZ)
- 4 on-board PGM outputs, positive or negative triggering (PGM4 only)
- Fits in a 8cm x 28cm x 7.6cm (11in x 11in x 3in) metal box



UDS | WinLoad Installer Upload/Download Software

- See full description on page 18

Wireless Keypads

Features Common to All Magellan Wireless Keypads

- Supports StayD
- View zone and system status live in real time
- Built-in transceiver (433MHz or 868MHz)
- In-field firmware upgradeable via a 307USB and WinLoad
- Fully functional: can be used to program the control panel
- 8 one-touch action buttons
- 3 keypad-activated panic alarms
- 2-partition keypads
- Compatible with MG5000, MG5050 and Spectra SP when using an RTX3



K32RF | 32-Zone Wireless LED Keypad

- 32-zone LED display
- StayD status LED
- Separate Arm, Sleep, Stay and Off LEDs per partition
- Adjustable backlight
- Includes 3.7Vdc Li-Ion rechargeable battery
- Requires 6Vdc power adaptor (PA6 not included)
- Wireless range in a typical residential environment: 40m (130ft)
- See Features Common to All Magellan Wireless Keypads on page 37



K37 | 32-Zone Wireless Fixed LCD Keypad

- View zone and system status live in real time
- Fixed message display that guides you in the operation of the system
- Goes into sleep mode after 20 seconds to save battery life, but remains synchronized with the panel in order to automatically wake up upon an entry delay or an alarm to provide full functionality (system status, zone display and buzzer)
- Displays the status of 32 zones in 2 partitions
- Displays StayD status
- Displays Arm, Sleep, Stay and Disarmed status for each partition
- Displays troubles, bypassed zones and alarm memory
- Adjustable backlight
- Fully powered by 2 AA alkaline batteries
- The 6Vdc power adaptor is not required but can be used as an alternative power source (PA6 not included)
- Wireless range in a typical residential environment: 40m (130ft)
- See Features Common to All Magellan Wireless Keypads on page 37



PA6 | 6Vdc Power Adapter Plug

- For the K32RF and K32W
- Provides 6Vdc at 350mA max
- Includes one of 5 different power outlets: ACPEU (Europe), ACPAUS (Australia), ACPCH (China), ACPUK (United-Kingdom) and ACPUL (North America)
- 6-foot wire

Hardwired Keypads



K32LCD | 32-Character Hardwired LCD Keypad

- See full description on page 30



K35 | 32-Zone Hardwired Fixed LCD Keypad

- See full description on page 30



- STAY D** **K636 | 10-Zone Hardwired LED Keypad**
- See full description on page 30



- STAY D** **K32 | 32-Zone Hardwired LED Keypad**
- See full description on page 30



K10V

K10H

- STAY D** **K10V | 10-Zone Hardwired LED Keypad (Vertical)**
K10H | 10-Zone Hardwired LED Keypad (Horizontal)
- See full description on page 30

Hardwired Zone Expansion Modules



- ZX8SP | 8-Zone Expansion Module**
- See full description page 31



- ZX8 | 8-Zone Expansion Module**
- See full description on page 22

System Accessories



- PGM4 | 4-PGM Expansion Module**
- See full description on page 25



- 307USB | Direct Connect Interface**
- See full description on page 26



- PMC5 | Hand-Held Plug-in USB Memory Key**
- See full description on page 26

Wireless Keypad



K32WK

**Industry-First
Real-Time
Wireless
Keypad**

Remote Controls



REM2



REM1

Wireless Accessories



RPT1



2WPGM



SD738
*Manufactured
by EVERday

All-In-One Wireless Consoles



MG6130



MG6160

Wireless Motion Detectors



PMD85



PMD75



PMD1P

Wireless Door Contacts



DCT2



DCTXP2



DCT10

Magellan All-in-One Wireless Consoles

Magellan is the first security system to combine security with popular consumer features and a stylish design. The Magellan line of all-in-one security systems and transmitters provide completely wireless security for any residential or small commercial installation. Magellan also features support for two-way wireless transmitters that allow users, for instance, to confirm the status of their systems through a remote control.

Magellan's 32-zone systems are quick and convenient to install and with their friendly menu-driven programming require practically no training whatsoever. And with their in-field firmware upgrade capability, you can conveniently update an installed system, on-site, within minutes.

The Magellan all-in-one security systems combine security with unique consumer features, such as high quality sound, a family message center, a hands-free speakerphone, an alarm and a designer look you may never have associated with security. With Magellan, you have security and so much more.

Security Features	MG6130	MG6160
• Built-in Transceiver	✓	✓
• Maximum Zones	32	32
• On-Board Hardwired Zones	2	2
• Users	16	16
• Remote Controls	16	16
• PGMs	4 (2 on-board)	4 (2 on-board)
• Events Buffered	256	256
• Wireless Keypads (K32WK)	4	4
• Wireless Repeaters	2	2
• Voice and Utility Reporting	✓	✓
• Pager Reporting	✓	✓
• Two-way Voice Communication	-	✓
• In-field Firmware Upgrade	✓	✓
• Auxiliary Output	✓	✓
Consumer Features		
• Hands-free Speakerphone	-	✓
• High-quality Voice and Sound	✓	✓
• Family Message Center	✓	✓
• Alarm Clock	✓	✓
• Access System Menus by Telephone	✓	✓
• Home Automation (X10)	-	✓

All-In-One Wireless Consoles



MG6130 | Magellan 32-Zone All-In-One Wireless Console

- Built-in transceiver (433MHz or 868MHz)
- 32 wireless zones
- Built-in 16-character LCD keypad with voice prompt
- High-quality voice and sound
- Family message center
- Alarm clock
- Voice, Utility and Pager reporting
- Patented 2 opto coupler dialer circuit - the most reliable dialer in the industry (US Patents 5751803, RE39406)
- Access system menus remotely by telephone
- Receive system status 3 ways (LEDs, LCD and voice)
- 57.6k baud communication with WinLoad
- 13.8Vdc, 200mA auxiliary output
- Wall or desktop mounting
- Chime zones
- 16 users and 16 remote controls
- 256 events buffered
- 2 on-board PGM outputs
- Built-in 90dB siren
- Includes 7.2V NiMH rechargeable battery pack (Paradox # 0780100172)
- Size: 21.8cm x 14.7cm x 3.6cm (8.6in x 5.8in x 1.4in)



MG6160 | Magellan 32-Zone All-In-One Wireless Console

- Same features as the MG6130 plus:
- Hands-free speakerphone
- Two-way voice communication with monitoring station
- Home automation (X10)
- Two-tone metallic silver and blue plastic enclosure



PA12 | 13.8Vdc Power Adapter Plug

- For the MG6130, MG6160 and 2WPGM
- Provides 13.8Vdc at 1A max
- Includes one of 5 different power outlets: ACPEU (Europe), ACPAUS (Australia), ACPCH (China), ACPUK (United Kingdom) and ACPUL (North America)
- 6-foot wire
- See wireless controls and devices on page 41



UDS | WinLoad Installer Upload/Download Software

- See full description page 18

Wireless Keypad



K32WK | 32-Zone Wireless LED Keypad

- Built-in transceiver (433MHz or 868MHz)
- 32-zone LED display
- Arm, Stay and Ready status LEDs
- Low Battery, Message and status LEDs
- Live Mode: View zone and system status live as they occur
- In-field firmware upgradeable via a 307USB and WinLoad
- Wireless range in a typical residential environment: 40m (130ft)
- 8 one-touch action buttons
- 3 keypad-activated panic alarms
- Adjustable backlight
- Includes 3.7Vdc Li-Ion rechargeable battery
- Requires 6Vdc power adaptor
- Compatible with MG6160 and MG6130



PA6 | 6Vdc Power Adapter Plug

- For the K32RF, K32WK and K37
- Provides 6Vdc at 350mA max
- Includes one of 5 different power outlets: ACPEU (Europe), ACPAUS (Australia), ACPCH (China), ACPUK (United Kingdom) and ACPUL (North America)
- 6-foot wire

Magellan Accessories



307USB | Direct Connect Interface

- See full description page 26



UIP256 | Universal In-Field Programmer

- Upgrade Magellan console and Grafica (V1.21 to 1.4) firmware locally in the field
- Includes proprietary PC software, cables to interconnect a Magellan console or a Grafica keypad and a PC, and two 9V batteries
- The supplied PC software retrieves the latest Magellan or Grafica update file (firmware) from our website and then updates the Magellan console or the Grafica keypad



PMC5 | Hand-Held Plug-in USB Memory Key

- See full description page 26

Magellan Wireless Controls and Devices

Magellan offers a complete line of wireless security devices, including keypads, motion detectors, door contacts, sirens, and remote controls. While wireless systems offer the same features and stylish design as traditional systems, installing a wireless Magellan system offers definite advantages to both the installer and user.

Installation time for a wireless system is a fraction of what is necessary for a traditional hardwired system. In addition, installing a wireless system requires little or no passing of wires through the installation site. With a wireless system, installers can also accurately estimate installation times, knowing that they will not be faced with any unexpected installation problems.

With their unmatched design, expandability, and ease of installation, Magellan wireless devices are an excellent choice.

Magellan Wireless Keypads



K32RF | 32-Zone Wireless LED Keypad

- See full description on page 38



K37 | 32-Zone Wireless Fixed LCD Keypad

- See full description on page 38



K32WK | 32-Zone Wireless LED Keypad

- See full description on page 43



PA6 | 6Vdc Power Adapter Plug

- See full description on page 38

Magellan Remote Controls

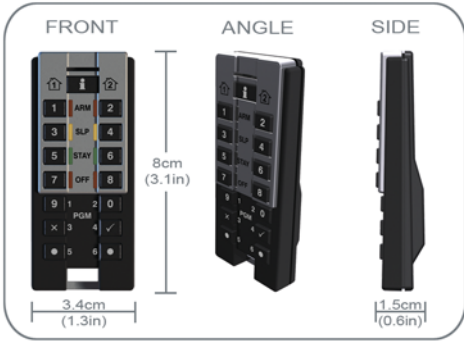

REM3 | Hand-Held 2-Way Remote Keypad

- Two User Modes
Keypad Mode: Requires code entry
Remote Mode: One-touch arm and disarm
- Supports StayD
- Built-in transceiver (433MHz or 868MHz)
- Provides visual and auditory feedback of actions performed
- Press the Status button at any time to receive the system status
- Displays Arm, Sleep, Stay, or Off status of partition 1 and 2
- *Diagnostic Display:* Place REM3 at location of desired transmitter:
 Partition 1 LEDs display signal strength
 Partition 2 LEDs display noise floor level
- Use keys to toggle up to 6 PGMs or generate a panic
- Includes key holder
- Label to identify remote control owner
- Compact, water-resistant design
- 8cm x 3.4cm x 1.5cm (3.1in x 1.3in x 0.6in)
- Compatible with MG5000, MG5050, EVO, and Spectra SP when using an RTX3



REM2 | Magellan 2-Way Remote Control with Backlit Buttons

- Supports StayD (Version 2.0 or higher)
- Built-in transceiver (433MHz or 868MHz)
- Displays system status using visual (LED) and auditory feedback
- Press the Status button at any time to receive the system status
- Perform up to 6 different actions per remote control
- Compact, water-resistant design with backlight for buttons
- Label to identify remote control owner
- Wireless range in a typical residential environment:
 30m (100ft) with MG6130 / MG6160
 45m (150ft) with MG5000 / MG5050 / RTX3



RAC2 | Magellan 2-Way Remote Control with Integrated Access Card

Same features as the REM2 plus:

- Built-in access card. Present remote control to a reader like an access card
- See supported readers on page 24

REM1 | Magellan Remote Control with Backlit Buttons

- Water resistant, stylish clear blue plastic with backlight for buttons
- Perform up to 5 different actions
- Label to identify remote control owner
- Wireless range in a typical residential environment:
 30m (100ft) with MG6130 / MG6160
 45m (150ft) with MG5000 / MG5050
 60m (200ft) with RTX3
- Available in 433MHz or 868MHz

RAC1 | Magellan Remote Control with Integrated Access Card

Same features as the REM1 plus:

- Built-in access card. Present remote control to a reader like an access card
- See supported readers on page 24

Magellan Wireless Motion Detectors

Features Common to All Magellan Wireless Motion Detectors

- Patented Auto Pulse Signal Processing
- Automatic Temperature Compensation
- Alive software (alarm LED continues to display when PIR is in energy save mode without compromising battery life)
- 3-minute energy save mode after two detections within a five-minute period
- Available in 433MHz or 868MHz
- Low battery and detect LED
- Anti-tamper switch



PMD1P | Analog Single-Optic PIR (18kg/40lb Pet Immunity)

- Dual element sensor
- Immune to animals weighing up to 18kg (40lb)
- 11m x 11m (35ft x 35ft) and up to 15m (50ft) for center beams with 88.5° viewing angle
- Wireless range in a typical residential environment:
35m (115ft) with MG6130 / MG6160
70m (230ft) with MG5000 / MG5050 / RTX3
- When a higher level of immunity is required, such as when animals are constantly in the detection area, consider using PMD75
- See Features Common to All Magellan Wireless Motion Detectors on page 46

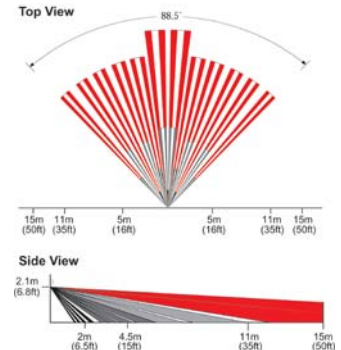

PMD75 | Digital Dual-Optic High-Performance PIR (40kg/90lb True Pet Immunity)

- Digital Motion Detection
- Dual optics (2 dual opposed element sensors)
- Immune to animals weighing up to 40kg (90lb)
- Digital Dual Opposed Detection
- Digital Shield algorithm with adjustable sensitivity
- Single or Dual Edge Processing
- 11m x 11m (35ft x 35ft) with 90° viewing angle
- Wireless range in a typical residential environment:
35m (115ft) with MG6130 / MG6160
70m (230ft) with MG5000 / MG5050 / RTX3
- See Features Common to All Magellan Wireless Motion Detectors on page 46

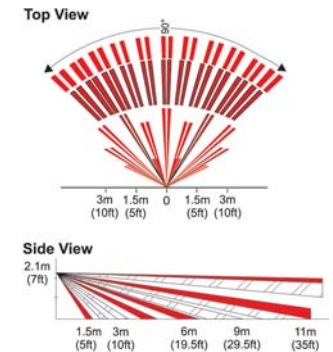

PMD85 | Outdoor Digital Dual-Optic High-Performance PIR

Same features as PMD75 plus a special weatherproof design:

- The PMD85 series is available with one of three lenses: Pet Array, Horizontal Curtain Beam or Vertical Curtain Beam. See PMD85 / DG85 Lenses on page 53 for more details
- Impact and temperature resistant casing
- Operates at -35°C to +50°C (-31°F to +122°F)
- Casing lined with an injected rubber gasket
- UV protected lens
- Dual Optical Filtering System
- Metal shield maximizes protection from EMI and RFI signals
- Multi-level sensitivity adjustment



Magellan Wireless Door Contacts



DCT10 | 2-Zone Long-Range Door Contact

- 2-zone capabilities where each zone is independent and has its own serial number
- Zone 1 - One of two high-sensitivity reed switches (magnet included) (N.O./N.C.)
- Zone 2 - Universal transmitter input (N.O./N.C.)
- Wireless range in a typical residential environment:
 - 35m (115ft) with MG6130 / MG6160
 - 70m (230ft) with MG5000 / MG5050 / RTX3
- Low battery and signal transmission LED
- Available in 433MHz or 868MHz
- Anti-tamper switch
- Dimensions: 12.4cm x 4.5cm x 3.3cm (4.9in x 1.8in x 1.3in)



DCTXP2 | 2-Zone Wireless Door Contact

- 2-zone capabilities where each zone is independent and has its own serial number
- Zone 1 - One high-sensitivity reed switch (magnet included)
- Zone 2 - Universal transmitter input (N.O./N.C.)
- Wireless range in a typical residential environment:
 - 30m (100ft) with MG6130 / MG6160
 - 60m (200ft) with MG5000 / MG5050 / RTX3
- Low battery and signal transmission LED
- Available in 433MHz or 868MHz
- Anti-tamper switch
- Dimensions: 11.2cm x 3.2cm x 2.5cm (4.4in x 1.3in x 1in)
- Available in white and brown



DCT2 | Ultra-Small Door Contact

- One high-sensitivity reed switch (magnet included)
- Wireless range in a typical residential environment:
 - 20m (65ft) with MG6130 / MG6160
 - 40m (130ft) with MG5000 / MG5050 / RTX3
- Available in 433MHz or 868MHz
- Anti-tamper switch
- Dimensions: 4.4cm x 3.0cm x 1.9cm (1.7in x 1.2in x 0.75in)

Magellan Wireless Siren



SR150 | Wireless Siren with Built-in Strobe

- Built-in transceiver (433MHz or 868MHz)
- 100db wireless siren with integrated strobe light
- Weather-resistant design using a PC/ABS enclosure with UV protection and a silicone coated PCB (-20°C to 50°C / -4°F to 122°F)
- Battery powered only, no need for AC power
- Fast alarm response time (4 seconds)
- 8-hour alarm display (strobe flashes every 4 seconds after bell cut-off)
- Siren presence supervised by control panel
- Panel presence supervised by siren (activates siren and strobe for 5 minutes if communication is lost)
- Triple tamper protection (screw removal, cover removal, and removal from wall)
- Assign up to 4 sirens per control panel
- In-field firmware upgradeable via 307USB
- Siren test mode
- 4-LED signal strength and status display
- Strobe lens available in 4 colours (red, blue, amber, and clear)
- Fully powered using three 1.5Vdc type "D" alkaline batteries (included). Not required, but can also be powered using 8-16Vac / 9-20Vdc power supply.
- Dimensions: 24cm x 6cm x 18cm (9.5in x 2.3in x 7 in)
- Compatible with MG5000, MG5050 and SP series when using an RTX3

Magellan Wireless Accessories



2WPGM | Magellan 2-Way Wireless PGM

- Built-in transceiver (433MHz or 868MHz)
- Backup Alarm Reporting option (activates PGM output if communication between the Magellan console and the 2WPGM is lost)
- 1 programmable 5A relay output
- Deactivate PGM after event or timer
- Requires an AC or DC input voltage (6Vac to 16.5Vac or 5Vdc to 30Vdc)
- Can be powered by the PA12 (see page 42)
- Universal transmitter input (N.O./N.C.)
- Wireless range in a typical residential environment:
35m (115ft) with MG6130 / MG6160, or 70m (230ft) with MG series / RTX3
- Anti-tamper switch
- Dimensions: 12.4cm x 4.5cm x 3.3cm (4.9in x 1.8in x 1.3in)

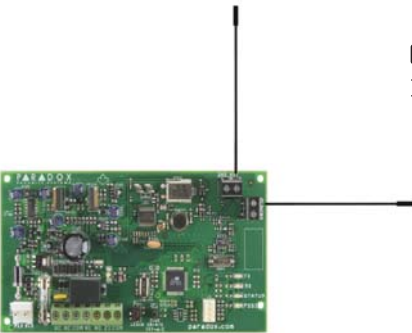

RPT1 | Magellan Wireless Repeater Module

- Built-in transceiver (433MHz or 868MHz)
- Extends the range of wireless communications
- Supports all Magellan transmitters (including 2-way transmitters)
- In-field firmware upgradeable via a 307USB and WinLoad
- Select which zone, PGM and/or keypad signals are repeated
- Signal strength display
- RF jamming supervision
- Fully supervised by panel or console
- 1 programmable 5A relay output
- Universal transmitter input (N.O./N.C.)
- Wireless range in a typical residential environment:
75m (240ft) with 433MHz, or 50m (160ft) with 868MHz
- Compatible with MG series, SP series with RTX3, Magellan Consoles
- AC input (16Vac, 20VA)
- Fits in 20cm x 25.5cm x 7.6cm (8in x 10in x 3in) and 28cm x 28cm x 7.6cm (11in x 11in x 3in) metal boxes



SD738 | EVERday Smoke Detector

- One high-sensitivity photoelectric smoke sensor
- Built-in siren
- Wireless range in a typical residential environment:
30m (100ft) with MG6130 / MG6160, or 60m (200ft) with MG series / RTX3
- Available in 433MHz or 868MHz
- Manufactured and available exclusively through **EVERday** Technology Co. Ltd. (Taiwan)

Stand-Alone Magellan Accessories



RTX3 | Wireless Expansion Module (Stand-Alone)

- See full description on page 8



PX8 | Output Module for Magellan Transceiver

- Connected to the RTX3 in stand-alone mode, the PX8 communicates the status of up to 8 wireless events, such as zone open/close, through its 8 hardwired outputs
- Set an output to signal a zone tamper, supervision loss or low battery
- Activate an output using specific buttons on an REM1 or RAC1 remote control
- Connect up to four PX8 on a single RTX3
- Outputs can follow events or have a delay of 1 to 999 seconds or minutes
- Use an RTX3 on-board PGM to supervise the PX8
- In-field firmware upgradeable via a 307USB and WinLoad

Motion Detectors

From outdoor and pet-friendly digital motion detectors to analog motion detectors, the Paradox series of motion detectors combine advanced features and patented technologies to provide a high level of detection and false alarm prevention.

The Digigard (DG55, DG65, DG75 and DG85 series), Elegance (DG483), Digital Vision (525D) and Paradome DG466 line of motion detectors offer patented digital motion detection. Developed for high-security applications, this advanced circuit design performs direct analog to digital conversion of the PIR sensor's signal using a powerful, high-speed microprocessor-based digital IC. Completely software-driven, true digital motion detection converts, amplifies and processes the sensor's low-level signal in the digital domain without any analog circuitry (no saturation, no loss of data and no noise). This unique technology provides increased accuracy, reliability and superior false alarm immunity.

The Digigard series includes the DG85 series Outdoor Digital Dual-Optic High-Performance PIR that combines a special weatherproof design and the proven technology of our DG75 Digital Dual-Optic High-Performance PIR (40kg/90lb True Pet Immunity) to provide the same reliable protection—outdoors. With its patented optics and digital processing technologies, the world-renown Digigard DG75 is a reliable false-alarm free motion detector with unmatched pet immunity.

Our patented Auto Pulse Signal Processing transforms the signal energy to a pulse output to determine if the progression of the detected occurrence corresponds to an alarm condition. Energy from the signals are measured and stored in memory until a minimum level is reached. The processor then rejects signals that do not meet its required specifications for generating an alarm.

Whatever the application, there's a Paradox motion detector that will suit your needs and surpass your expectations.

Digital Motion Detectors



Features Common to All Digital Motion Detectors

- Patented* Digital Motion Detection (see above)
- Patented Auto Pulse Signal Processing
- Digital Shield algorithm software with adjustable sensitivity
- Single or Dual Edge Processing†
- Automatic Temperature Compensation
- Metal shield maximizes protection from EMI and RFI signals†‡
- Solid-state relay
- Anti-tamper switch

* The patent does not apply to the DG467 (see page 51)

† Except DG466 (see page 51)

‡ Except DG483 (see page 49) and DG467 (see page 51)

DG483 | Elegance Digital Motion Detector

- Dual element sensor
- 10m x 10m (32ft x 32ft); 85° viewing angle
- Unique simple design
- Small size 8.5cm x 5.2cm x 3.5cm (3.3in x 2in x 1.4in)
- Includes corner bracket
- Fresnel FLAT Lodif segment lens array: 11m X 11m (35ft X 35ft); 85°
- See Features Common to All Digital Motion Detectors above

Elegance

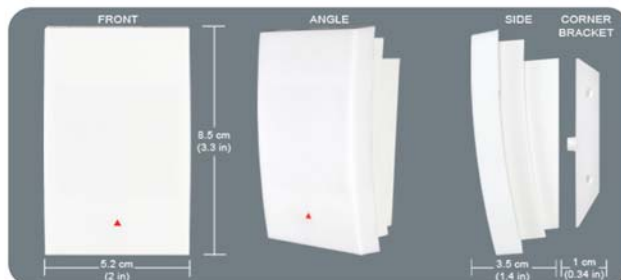
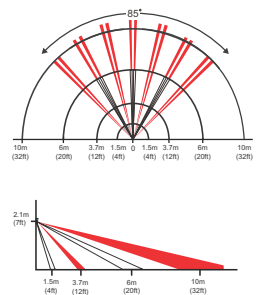



DG55 | Dual Element Digital Motion Detector

- Dual element sensor
- 12m x 12m (40ft x 40ft); 110° viewing angle
- See Features Common to All Digital Motion Detectors on page 49

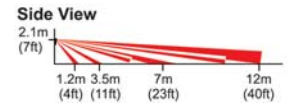
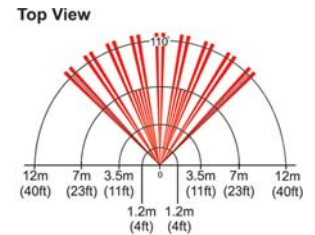

DG65 | Quad Element Digital Motion Detector

- Digital Dual Opposed Detection
- Interlock Sensor Geometry
- Quad element sensor
- 12m x 12m (40ft x 40ft); 110° viewing angle
- See Features Common to All Digital Motion Detectors on page 49



DG75 | Digital Dual-Optic High-Performance PIR (40kg/90lb True Pet Immunity)

- Extremely reliable and false-alarm free
- Dual optics (2 dual opposed element sensors)
- Provides superior pet immunity using a patented combination of advanced optics and digital processing technologies
- Immune to pets weighing up to 40kg (90lb)
- Digital Dual Opposed Detection
- 11m x 11m (35ft x 35ft); 90° viewing angle
- See Features Common to All Digital Motion Detectors on page 49

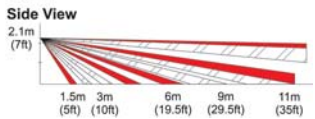
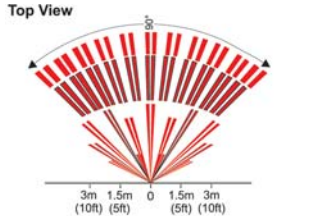

DG85 | Outdoor Digital Dual-Optic High-Performance PIR

Same features as the DG75 (see above) plus a special weatherproof design:

- The DG85 series is available with one of three lenses: Pet Array, Horizontal Curtain Beam or Vertical Curtain Beam. See PMD85 / DG85 Lenses on page 53 for more details
- Impact and temperature resistant casing
- Operates at -35°C to +50°C (-31°F to +122°F)
- Casing lined with an injected rubber gasket
- UV protected lens
- Digital Dual Opposed Detection
- Dual Optical Filtering System
- Multi-level sensitivity adjustment
- Two operational modes (addressable for the EVO series or conventional relay operation)
- Can be used with the Heavy Duty Outdoor Swivel Bracket (SB85)



525D | Microwave and Infrared Digital Motion Detector

- Digital microwave detection
- 3 LED indicators display type of movement
- Once the PIR validates that a signal meets alarm conditions, Digital Vision uses microwave signals to confirm the results before generating an alarm
- Adjustable microwave range
- 14m x 14m (45ft x 45ft); 90° viewing angle
- See Features Common to All Digital Motion Detectors on page 49

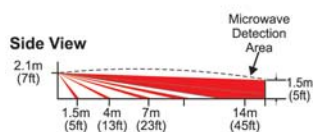
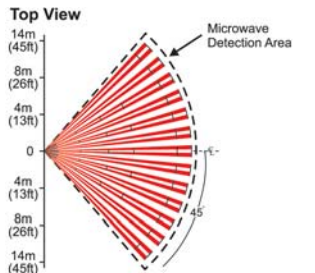



DG466 | Directional Ceiling-Mounted Digital Motion Detector

- Two dual element sensors (determine if movement is incoming or outgoing)
- One incoming detection relay output
- One outgoing detection relay output
- Adjustable return delay timer (exit and reenter without causing an alarm)
- 67cm x 4.8m (2.2ft x 16ft) and 60cm x 4.8m (2ft x 16ft)
- See Features Common to All Digital Motion Detectors on page 49

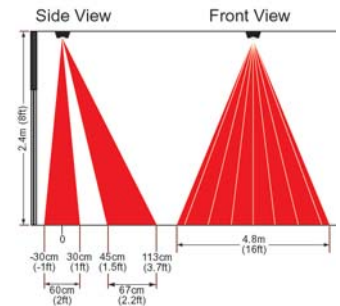

DG467 | 360° Ceiling Mounted Motion Detector

- See full description on page 21

Analog Motion Detectors

Features Common to All Analog Motion Detectors

- Patented Auto Pulse Signal Processing
- Automatic Temperature Compensation
- Metal shield maximizes protection from EMI and RFI signals
- Dual element sensor
- Anti-tamper switch



476+ | PIR with High EMI and RFI Rejection

- Extremely high EMI and RFI rejection
- PCB uses only surface mount components
- Solid-state relay
- 11m x 11m (35ft x 35ft); 110° viewing angle
- See Features Common to All Analog Motion Detectors on page 51

Top View

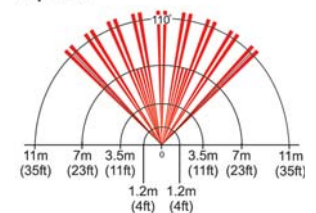

Side View

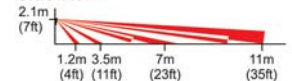

476PET | Analog Single-Optic PIR (18kg/40lb Pet Immunity)

- Immune to animals weighing up to 18kg (40lb)
- When a higher level of immunity is required, such as when animals are constantly in the detection area, consider using DG75
- 11m x 11m (35ft x 35ft) and up to 15m (50ft) for center beams with 88.5° viewing angle
- Extremely high EMI and RFI rejection
- PCB uses only surface mount components
- Solid-state relay
- See Features Common to All Analog Motion Detectors on page 51

Top View

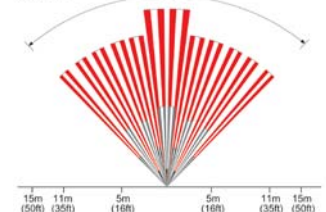

Side View





460 | Vertical View Motion Detector

- Adjustable lens position (0° or 10°)
- Selectable operational voltage (12Vdc or 24Vdc)
- Adjustable alarm signal duration
- Detects hand-sized objects for card access applications: 2.1m x 1.5m (7ft x 5ft)
- Detects body-sized objects for security applications: 6m x 4.5m (20ft x 15ft)
- See Features Common to All Analog Motion Detectors on page 51

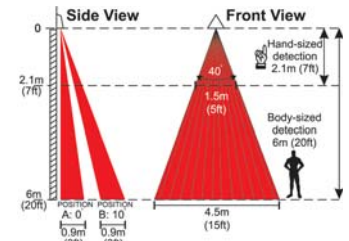

Specialized Detectors and Accessories



DG457 | Digital Glassbreak Bus Detector

- See full description on page 21

457 | Digital Glassbreak Detector

- Same features as the DG457 (see above) except:
- Conventional relay operation only



459 | Test Trek

- Toggle test mode remotely
- Use with DG457 and 457 to test the modules



950 | Safe Protector

- High-sensitivity piezoelectric element
- Five sensitivity settings
- 2.5m (8ft) protection range
- Anti-tamper switch



SB469 | Swivel Mount Bracket

- 3 in 1: ceiling, wall or corner mount bracket
- Ensures optimal coverage



SB85 | Heavy Duty Outdoor Swivel Bracket

- For use with the PMD85 (page 46) and DG85 series (page 50) outdoor digital PIRs
- Innovative T-joint allows for movement along two axes for better maneuverability and better detector positioning
- 3 in 1: ceiling, wall or corner mount bracket
- Cap lock prevents unauthorized repositioning of outdoor detector



Lenses

The following beam patterns represent the optional lenses that are available for the Pro+ (476+), Digigard 55 (DG55), Digigard 65 (DG65), Digiplex Motion Detector Modules (DM50 and DM60), Digital Vision (525D) and Magellan (PMD1P) motion detectors. Distances shown may vary according to the selected motion detector; please verify the motion detector's specifications.

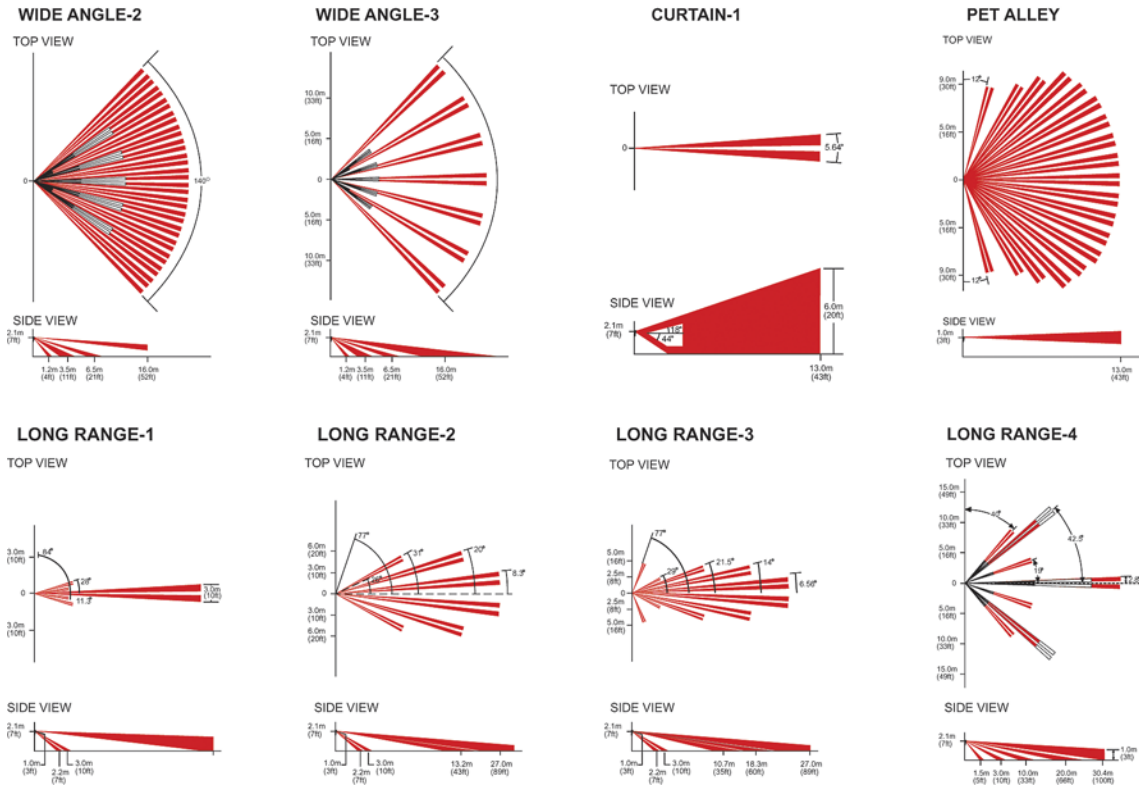

PMD85 / DG85 Lenses

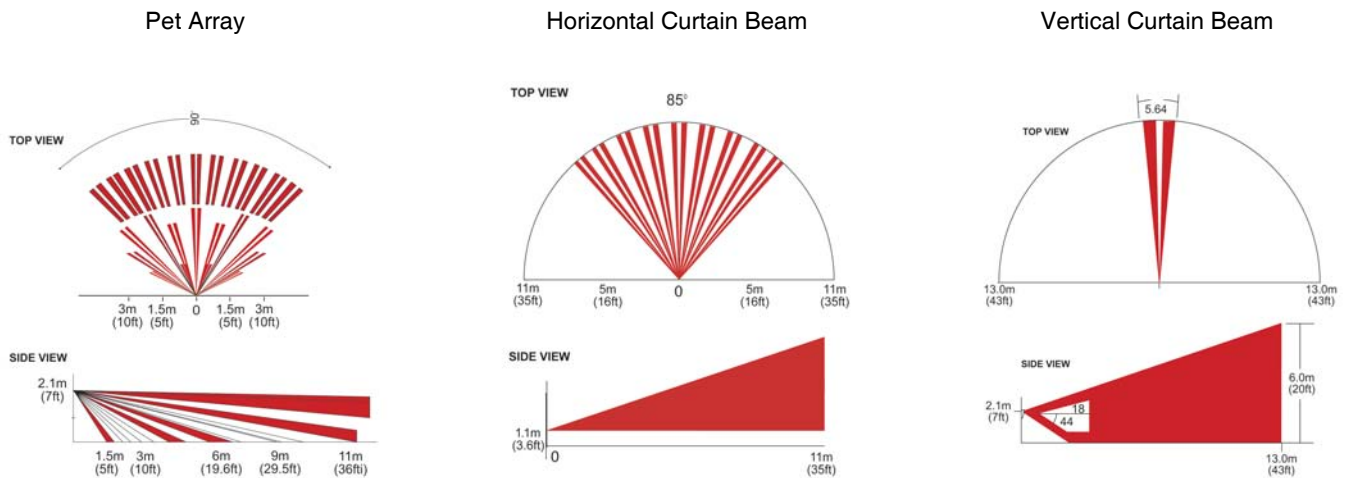

- Patented Animal Immunity (up to 40kg/ 90lbs)
- 11m x 11m (35ft x 35ft) with 90° viewing angle

- Allows large-breed dogs and multiple pets to roam free below the 1.1m (3.6ft) detection level
- 11m x 11m (35ft x 35ft) with 90° viewing angle

- Protect corridors or vertical surfaces such as walls or balcony doors
- 13m (43ft) x 2 beams; 5.64° viewing angle

Motion Detector Comparison Chart

Features	Products														
	DG483	DG55	DG65	DG75	DG85	525D	DG466	DG467	476+	476PET	460	PMD1P	PMD75	PMD85	
Digital Detection	✓	✓	✓	✓	✓	✓	✓	-	-	-	-	-	✓	✓	
Auto Pulse Signal Processing	✓	✓	✓	✓	✓	✓	✓	✓	✓	✓	✓	✓	✓	✓	
Auto Temp. Compensation	✓	✓	✓	✓	✓	✓	✓	✓	✓	✓	✓	✓	✓	✓	
Shield Algorithm	✓	✓	✓	✓	✓	✓	✓	✓	-	-	-	-	✓	✓	
Dual Edge Proc.	✓	✓	✓	✓	✓	✓	-	✓	-	-	-	-	✓	✓	
Dual Opposed	-	-	✓	✓	✓	-	-	-	-	-	-	-	✓	✓	
Interlock Sensor Geometry	-	-	✓	-	-	-	-	-	-	-	-	-	-	-	
Special	-	-	-	-	Outdoor	Micro-wave	Directional	-	-	-	Vertical view	Wireless	Wireless	Wireless Outdoor	
Animal Immunity	-	-	-	40kg/90lb	40kg/90lb	-	-	-	-	18kg/40lb	-	18kg/40lb	40kg/90lb	40kg/90lb	
Metal Shield	-	✓	✓	✓	✓	-	-	-	✓	✓	✓	-	-	✓	
Sensor	Dual element	Dual element	Quad element	2 Dual elements	2 Dual elements	Dual element	2 Dual elements	Dual element	Dual element	Dual element	Dual element	Dual element	2 Dual elements	2 Dual elements	
Coverage (Viewing Angle)	m:10 x 10 ft: 33 x 33 85°	m:12 x 12 ft: 40 x 40 110°	m:12 x 12 ft: 40 x 40 110°	m:11 x 11 ft: 35 x 35 90°	See page 53	m:11 x 11 ft: 35 x 35 90°	see page 51	see page 51	m:11 x 11 ft: 35 x 35 110°	see page 51	see page 52	see page 46	m:11 x 11 ft: 35 x 35 90°	See page 53	
Optional Lenses	-	✓	✓	-	✓	✓	-	-	✓	-	-	✓	-	✓	

Control Panel Comparison Chart

Features	Products										
	Imperial V32	EVO48	EVO192	SP5500	SP6000	SP7000	E55	E65	MG6130 MG6160	MG5000	MG5050
Zones On-board/ max	8 / 384	8 / 48 + 8 virtual	8 / 192 + 8 virtual	5 / 32	8 / 32	16 / 32	4 / 32	9 / 32	2 / 32	2 / 32	5 / 32
Partitions (areas)	32	4	8	2	2	2	2	2	-	2	2
Users	256 (+ 3744 cards)	96	999	32	32	32	32	32	16	32	32
PGMs On-board / max	5 / 350	2 / 250	5 / 250	2 / 16	2+2 / 16	4 / 16	1	3	2	2 / 16	4 / 16
Expansion Modules	511	127	254	15	15	15	15	15	-	15	15
Wireless Expansion	-	✓	✓	✓	✓	✓	-	-	✓	✓	✓
In-Field Upgradeable	✓	✓ †	✓ ‡	✓**	✓**	✓**	✓	✓*	✓**	✓**	✓**
Built-in Access Control	64 Doors	32 Doors	32 Doors	-	-	-	-	-	-	-	-
Buffered events	32000 Access 2000 Security 10000 Mama	1024	2048	256	256	256	256	256	256	256	256
Software	BabyWare	NEware WinLoad	NEware WinLoad	WinLoad	WinLoad	WinLoad	WinLoad	WinLoad	WinLoad	WinLoad	WinLoad

* 16 PGMs, 4 keypads, 2 repeaters

** 32 zones, 32 remotes, 4 sirens, 16 PGMs, 8 keypads, 2 repeaters

† 48 zones, 96 remotes, 8 PGMs per RTX3

‡ 192 zones, 999 remotes, 8 PGMs per RTX3

Patents

One or more of the following US patents may apply: 7046142, 6215399, 6111256, 6104319, 5920259, 5886632, 5721542, 5287111, 5119069, 5077549 and RE39406 and other pending patents may apply. Canadian and international patents may also apply.

Trademarks

Imperial, BabyWare, Esprit E55, Esprit, 728 Ultra, 738 Ultra, Espload, Spectra, Spectra SP, WinLoad, Digiplex, Digiplex EVO, NEware, Grafica, Elegance, Digigard, Digital Vision, ProPlus, ProPET, Parador, Paradome, GlassTrek and Magellan are trademarks or registered trademarks of Paradox Security Systems Ltd. or its affiliates in Canada, the United States and/or other countries. All rights reserved. LODIFF® is a registered trademark of Fresnel Technologies Inc. Windows® is a registered trademark of Microsoft Corporation.

Approvals

For the latest information on product approvals, such as UL and CE, please visit our website at paradox.com.

Specifications

Specifications may change without prior notice. Printed in Canada - 07/2009; CATA09-G2K (rev05)
© 2002-2009 Paradox Security Systems Ltd.



The Paradox Company: History and Goals

Personalized Service, Innovative Technology Since 1989

With the introduction of the Imperial system in this Product Catalogue, I am proud to present the Paradox history and philosophy that brought us here.

At Paradox Security Systems, our mission is to provide our customers with personalized service, to manufacture innovative and quality products, and to continually build a strong team consisting of our customers, employees, and suppliers. We see this team as one team committed to move forward together, with one unique and common goal.

As a private company, we are not driven by short-term profit or concerned with stock pricing. We are proud to operate in a more traditional manner; our fuel is our passion towards developing innovative products, all the while fulfilling our customer's wishes and listening to their feedback.

Our products are sold only to and through our loyal distributors in over 100 countries, most of them exclusive Paradox distributors. This approach ensures that they receive our undivided attention.

We are not driven by sales, but by supporting our distributors and dealers with the best service and products. We are proud to be able to say that 90% of distributors and most of our suppliers that started with us in the 1980's are still our loyal customers today.

Every year, we invest heavily into our research and development department. We are always focused on the future. Our goal is to constantly refine our products and adapt to changing technologies and new standards of living. The steadily growing R&D team at Paradox Innovation is continually challenged to create products that are innovative, easy to use, and stand out - both technologically and aesthetically.

Since 1989, these goals have driven the development of revolutionary products. We started with an impressive line of motion detectors whose patents are still used in our products today. In 1999, we introduced the Digiplex series of security systems, featuring our encrypted expandable bus system. In 2004, we introduced an extensive range of wireless systems, including the award-winning Magellan all-in-one console. Over the last few years, our focus has shifted progressively towards software development. In 2007, we revamped and shifted many products to new platforms, including the MG, SP, and EVO series. We also introduced advanced communication modules using GPRS, GSM, and IP, and in-field firmware upgradeable hardware. We are also proud of our history, and showed it by re-introducing the Elegance a beautifully styled motion detector that we first produced 20 years ago.

With personalized service and innovative technology since 1989, the Paradox team works together with our customers and suppliers to reach our goals!

Shmuel HersHKovitz
Founder and owner
Shmuelh@paradox.com

WORLDWIDE OFFICES



Montreal
Manufacturing Center & Paradox Innovation (R&D)



Miami
Distribution Center



Bahamas
International Sales Office



GPRS / IP Monitoring Receiver IPR512



Up to 512 supervised Paradox control panels can report system events to the IPR512 receiver over an IP network via a Paradox GPRS/IP reporting module (PCS Series / IP100). All this is achieved through proprietary encrypted communication between the control panel, the Paradox reporting module, and the IPR512 receiver. The IPR512 receiver also supervises the automation software and all 512 connections (control panel presence and IP communication) at a configurable rate.

- 512 Supervised Paradox IP reporting modules
- Redundant Internet Service Provider (WAN1/WAN2)
- 2 serial ports (COM1/COM2)
- Integrated account management web page (LAN)
- Data backup on external memory card
- End-to-end supervision
- Firmware upgradeable
- 256-bit AES data encryption
- Supports 19" rack mounting (1U) or desktop installation
- Automatic date and time synchronization via Network Time Protocol (NTP)

