

THERMAL CONDUCTIVITY INSTRUMENTS

New Castle, DE USA

Lindon, UT USA

Saugus, MA USA

Hüllhorst, Germany

Shanghai, China

Beijing, China

Tokyo, Japan

Seoul, South Korea

Taipei, Taiwan

Bangalore, India

Sydney, Australia

Guangzhou, China

Eschborn, Germany

Wetzlar, Germany

Brussels, Belgium

Etten-Leur, Netherlands

Paris, France

Elstree, United Kingdom

Barcelona, Spain

Milano, Italy

Warsaw, Poland

Prague, Czech Republic

Sollentuna, Sweden

Copenhagen, Denmark

Chicago, IL USA

São Paulo, Brazil

Mexico City, Mexico

Montreal, Canada





LaserComp Thermal Conductivity

Thermal conductivity measures the ability of a material to transfer heat. Exact measurements of this material property are essential for understanding and optimizing energy efficiency and predicting thermal performance of materials in a wide range of industries including construction, electronics, aerospace, automotive, and many more.

TA Instruments proudly presents a line of cutting-edge instruments for the direct measurement of heat flow of low to medium conductivity materials: the LaserComp FOX series of heat flow meters and guarded hot plate. The FOX Series provides end-users with unique features and the widest range of possible configurations to meet every measurement need.

Let us show you why, for over 50 years, scientists and engineers have relied upon TA Instruments systems for the most advanced, reliable, and sensitive instruments for thermal property measurement.

Heat flow meter

LASERCOMP HEAT FLOW METERS

FOX instruments utilize a steady state technique for the determination of thermal conductivity. The Heat Flow Meter Method, designed specifically for insulating materials, is defined by international standards ASTM C518, ISO 8301, and DIN EN 12667. This cost-effective and practical method is widely recognized and preferred by industry professionals throughout the world for its speed, simplicity, and accuracy.

In a heat flow meter, a specimen is positioned between two temperature-controlled plates. These plates establish a user-defined temperature difference (ΔT) across the sample. The sample thickness (L) is set to match the target thickness of compressible samples, or the actual sample dimension. Accurate sample thickness is critical. Only the FOX Series incorporates four optical encoders, one at each corner, to ensure the utmost accuracy. The resulting heat flux (Q/A) from steady-state heat transfer through the specimen is measured by two proprietary thin film heat flux transducers covering a large area of upper and lower sample surfaces. This unique technology, unlike competitive designs, insures the most sensitive and exact measurement of heat flow.

The average heat flux is used to calculate the thermal conductivity (λ) and thermal resistance (R), according to Fourier's Law.

$$\lambda = \frac{Q}{A} \frac{L}{\Delta T}$$

UNITS	(W/mK) (Btu in/h ft ² F)
-------	--

$$R = \frac{1}{\lambda} L$$

UNITS	m ² K/W (h-ft ² -F/Btu)
-------	--

Features

- Solid state heating/cooling for precise temperature control
- Optical encoders for the most accurate digital measurement of sample thickness
- Proprietary thin film heat flux transducers for the most representative sample heat flow measurement
- Powerful WinTherm software for enhanced testing functionality
- Automatic sample feeder for high-throughput analyses
- Stand-alone or PC-based operation
- Conforms to standard test methods:

Thermal Conductivity

ASTM C518 ISO 8301 DIN EN 12667

Specific Heat

ASTM C1784

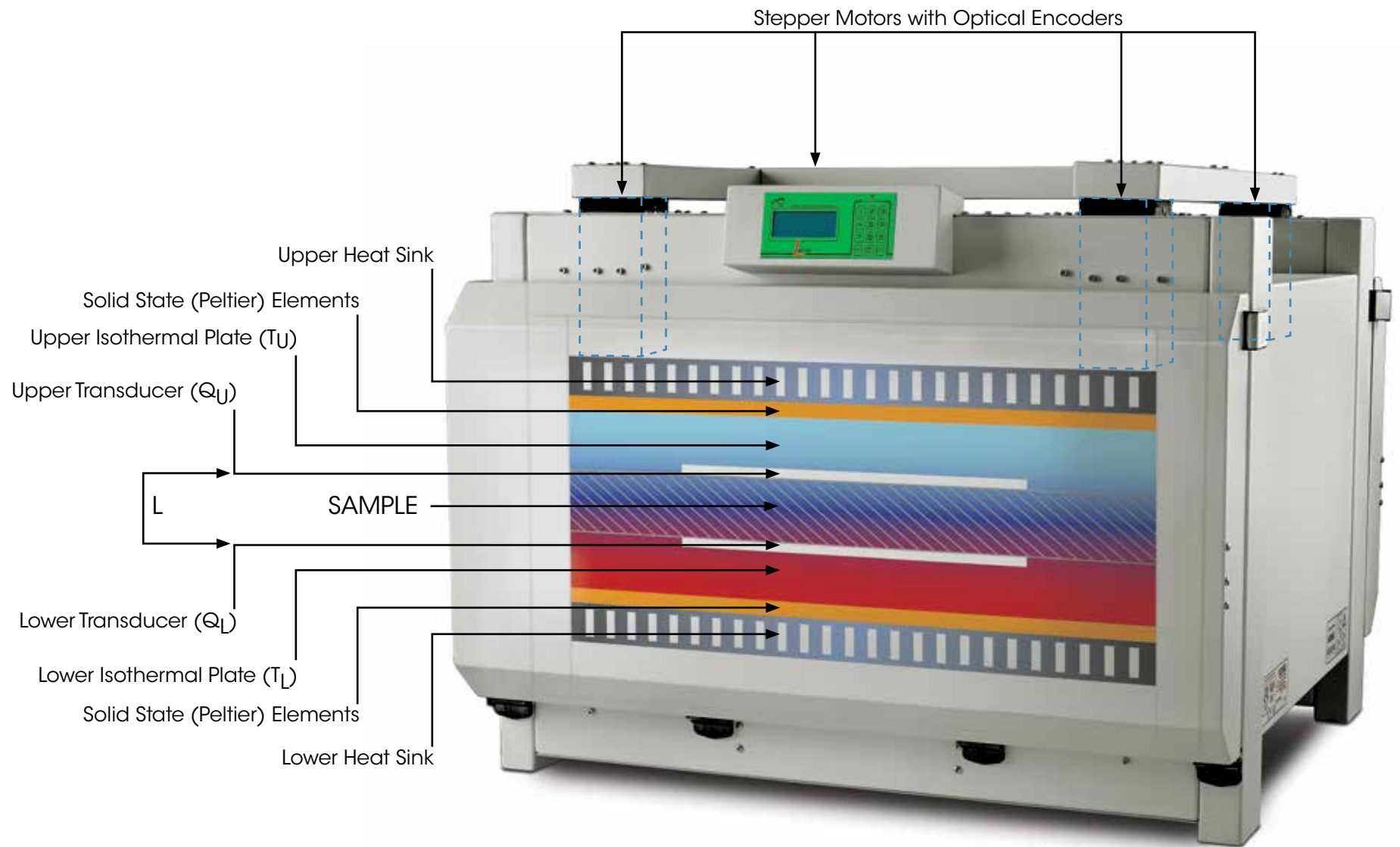

An Instrument for Every Application

The most meaningful thermal conductivity measurements are performed on samples with dimensions representative of real world conditions. These dimensions, such as sample thickness to width ratio, are requirements often outlined by international standards. Four models of the FOX Series Heat Flow Meters accommodate the widest range of sample dimensions. Each instrument has the flexibility to test samples with smaller dimensions and oversized samples can be tested in the open-door configuration without sacrificing measurement precision and accuracy.



	FOX 200	FOX 314
Maximum Sample Thickness	51 mm (2 inch)	100 mm (4 inch)
Square Sample Width ^[1]	200 mm (8 inch)	300 mm (12 inch)
Temperature Range	-20 °C to 75 °C	-20 °C to 75 °C
Temperature Resolution	±0.01 °C	±0.01 °C
Accuracy	±1%	±1%
Reproducibility	±0.5%	±0.5%
Thermal Conductivity Range ^[2]	0.005 to 0.35 W/m•K (0.035 to 2.4 BTU in/hr ft ² °F)	0.005 to 0.35 W/m•K (0.035 to 2.4 BTU in/hr ft ² °F)
Available Configurations	Automatic Sample Feeder External Thermocouple Kit Vacuum	Automatic Sample Feeder External Thermocouple Kit Linear Gradient Guard
Proprietary Thin Film Heat Flux Transducer	75 mm × 75 mm (3 in) Top and bottom	100 mm × 100 mm (4 in) Top and bottom



	FOX 600	FOX 801
Maximum Sample Thickness	200 mm (8 inch)	300 mm (12 inch)
Square Sample Width ^[1]	610 mm (24 inch)	762 mm (30 inch)
Temperature Range	-15 °C to 65 °C	-10 °C to 65 °C
Temperature Resolution	±0.01 °C	±0.01 °C
Accuracy	±1%	±1%
Reproducibility	±0.5%	±0.5%
Thermal Conductivity Range ^[2]	0.001 to 0.35 W/m·K (0.007 to 2.4 BTU in/hr ft ² °F)	0.001 to 0.35 W/m·K (0.007 to 2.4 BTU in/hr ft ² °F)
Available Configurations	Automatic Sample Feeder External Thermocouple Kit Rotational System	Automatic Sample Feeder External Thermocouple Kit Rotational System
Proprietary Thin Film Heat Flux Transducer	254 mm × 254 mm (10 in) (ASTM) 300 mm × 300 mm (12 in) (ISO) Top and bottom	254 mm × 254 mm (10 in) (ASTM) 300 mm × 300 mm (12 in) (ISO) Top and bottom

^[1] Guard materials may be used to test specimens that are less than the nominal width

^[2] External Thermocouple Kit extends conductivity range to 2.5 W/m·K

Linear Optical Encoders improve accuracy

The accuracy of a thermal conductivity measurement is directly affected by the precision of the measurement of sample thickness. Unlike competitive units that rely on a single analog measurement of thickness, with limited accuracy, the FOX Heat Flow Meters feature optical encoders and stepper motors for **independent position control and measurement at all four plate corners**. This gives the system the ability to level the plates to conform to samples with non-parallel surfaces, improving thermal contact and providing a truly representative measurement of sample thickness to within 25 μm . The plates may be positioned either to a user-defined thickness for soft compressible samples, or using Auto-Thickness function for rigid samples, in which the plate automatically moves to establish full contact with the sample.



Stepper Motor with
Optical Encoder

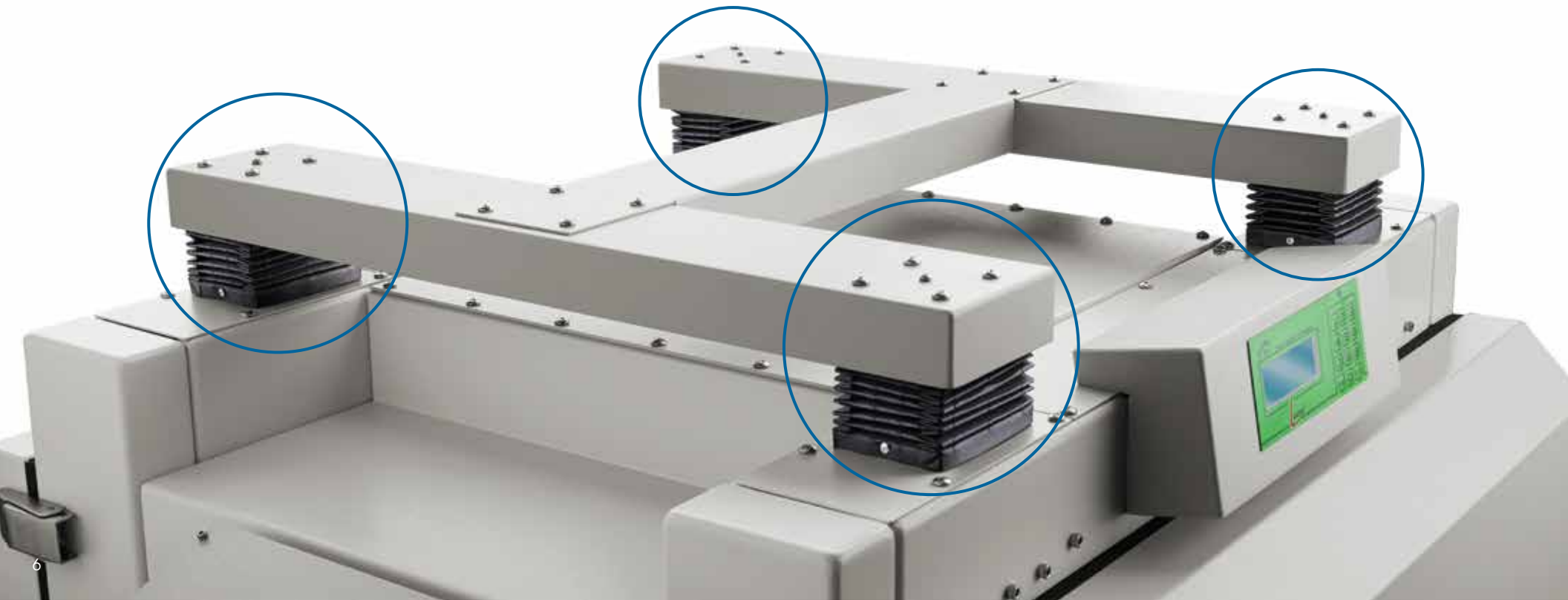

Advanced Heat Flux Measurement

The Fox heat flux transducer delivers a **true**, undistorted measurement of the total heat flux, with durability over a long operating lifetime. The proprietary thin film design of the transducer (< 1 mm thick) is made from a continuous surface of sensing junctions that integrate evenly over the entire sensor area. A type-E thermocouple is bonded in the center of each transducer within 0.1 mm of the samples surface and sealed against moisture. The design provides for the most representative sample temperature and heat flow measurements, simple and robust calibrations, no susceptibility to edge losses or gains, and better testing of heterogeneous materials.



Precision Temperature Control

Two arrays of solid-state Peltier elements provide responsive heating and cooling to each of the plates. The low-mass, high-output Peltier elements enable fast attainment of set-points, improving productivity. Plate temperature control is driven by responsive thermocouples in close contact with the sample. An advanced temperature control algorithm continuously maintains the plate temperatures and rapidly brings the system to full thermal equilibrium.

A unique feature of the Fox systems is the ability to heat or cool the top and bottom plates, allowing for testing with heat flow either up or down.

FOX Heat Flow Meters utilize a recirculating chiller system as a heat exchanger, allowing the Peltier elements to operate at the necessary power output.



System configurations

FOX HEAT FLOW METER

FOX 304 with Linear Gradient Guard

The FOX 304 is a specialized configuration of the FOX 314 that includes a Linear Gradient Guard. This provides an active thermal guarding system on all four sides of the plates, precluding distortions in results due to edge heat loss or gain when testing thick samples. This minimizes dependence of calibration factor on thickness, decreases the time to thermal equilibrium, and **improves accuracy of tests for very thick samples.**

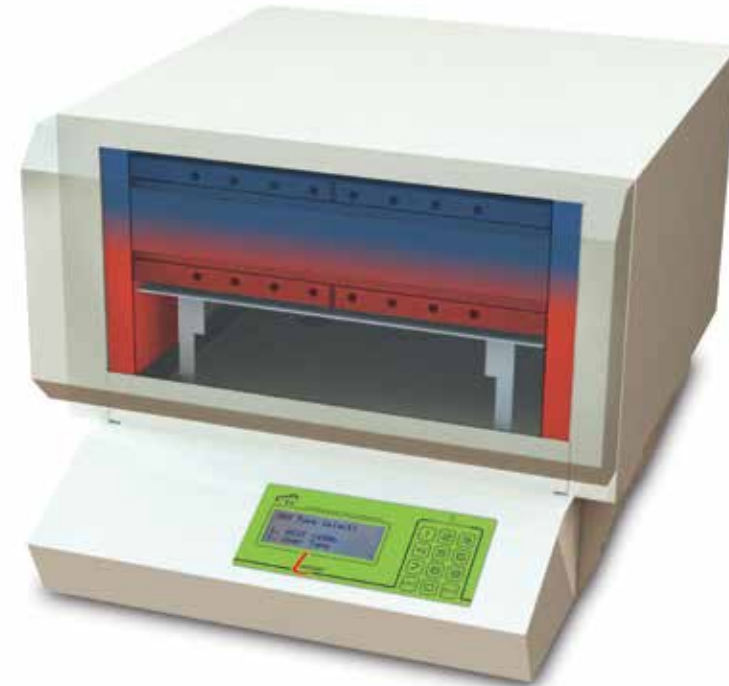

External Thermocouple Option

Thermocouples are attached directly to the sample surfaces, eliminating the impact of interface resistance, and improving the measurement accuracy for higher thermal conductivity samples (up to $2.5 \text{ W/m}\cdot\text{K}$). External thermocouples are placed in contact with the sample or placed in grooves machined in rigid specimens. Instruments configured for this option feature auxiliary outlets for the external thermocouples.

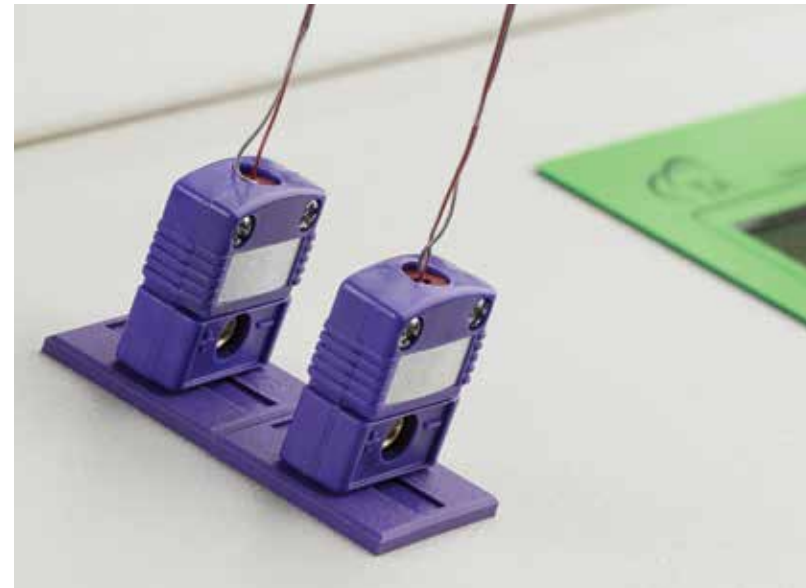
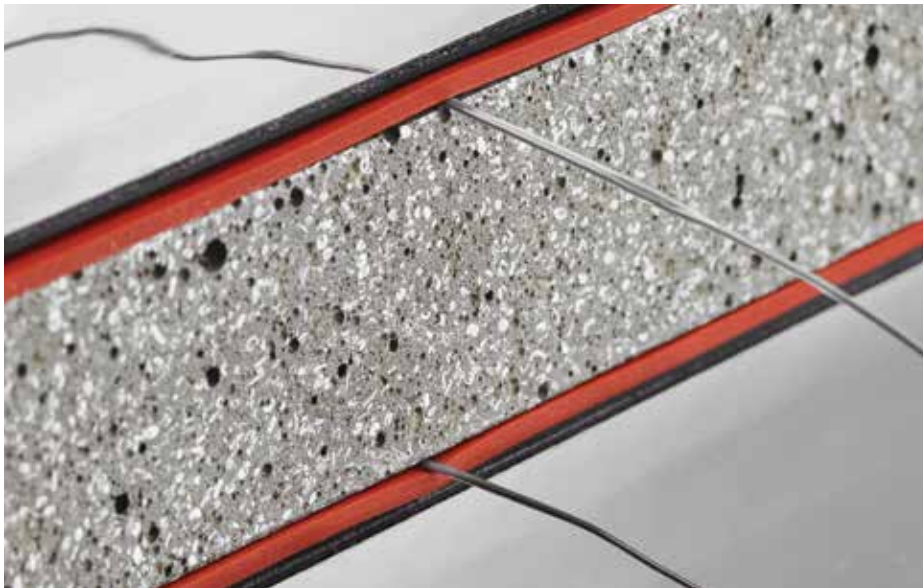

Measurement Under Vacuum

Certain applications such as the design of vacuum insulation panels and the evaluation of blowing agents require operation under vacuum or controlled atmosphere. The FOX 200 Vacuum features sealed electronics, water lines, and motor shafts for operation within an evacuated chamber. The test chamber can also be back-filled with purge gas. The FOX 200 Vacuum allows the test environment to be evacuated while the plates remain open. The plates can then be closed according to a user-defined gap or Auto-Thickness protocol. When paired with a turbomolecular pump, vacuum as high as 10^{-10} atm is possible.



Rotational System Option

The FOX 600 and FOX 801 Heat Flow Meters can be configured with the innovative Rotational System. This unique accessory allows thermal conductivity to be measured under conditions which match the installation orientation. The rugged system motor can be rotated to angles between 0° and 90° .

Cryogenic Measurements - FOX 200LT

The FOX 200LT incorporates liquid nitrogen cooling for sub-ambient testing. Gaseous nitrogen circulates through the plates to provide accurate temperature control from -175°C to 50°C . Plate positioning control ensures that plates remain in contact with the sample, to account for changes due to thermal expansion or contraction.

System configurations

FOX HEAT FLOW METER

Automation

Improve productivity with the Automatic Sample Feeder (ASF) available for all models. The ASF is mounted to the back of the instrument and is controlled directly by the WinTherm Instrument Control Software. The ASF automatically loads and unloads up to 20 standard size samples (stack height 500 mm). Additional samples can be added while a test is in progress.

Calibration Materials

Standard materials may be purchased for verification test and re-calibration of all FOX Series Heat Flow Meters. Expanded Polystyrene specimens tested and verified by the LaserComp Laboratory are available for routine verification tests. Fiberglass reference materials certified by the National Institute of Standards and Technology (NIST) or the Institute for Reference Materials and Measurements (IRMM) are also available.

The long-term stability of FOX systems means that calibrations and corrections are often not required for several years.





Oversized Samples

The FOX 600, FOX 800, and FOX 1000 include test-chamber doors at both the front and back of the instrument. Long samples such as window assemblies or vacuum insulation panels can be tested with the excess extending out the front and back of the instrument, allowing specimens to be tested exactly as manufactured. The FOX 1000 is for extremely large samples, especially large format vacuum insulation panels. The plate size is 1041 mm x 762 mm (41" x 30"). The test chamber allows specimens that are up to 1050 mm wide and of unlimited length. The thickness of the sample can be from 0 to 100 mm (0 to 4" thick). Both instrument plates can operate between 0 °C and 45 °C with heat flow in either direction.



- Testing Zone
- Controlled Edge

Dual Zone Temperature Control

Very large specimens with significant edge surface area are more prone to errors associated with lateral temperature gradients and heat losses. The FOX 600, FOX 801, and FOX 1000 feature an innovative dual-zone plate design that separately controls temperature at the interior and periphery of the plate surface. This ensures temperature uniformity across the sample width at both plate surfaces and purely linear heat flow, resulting in the most accurate thermal conductivity measurement regardless of specimen thickness or ambient temperature.

FOX 50

FOX HEAT FLOW METER



The FOX 50 Heat Flow Meter is an accurate, easy-to-use instrument for measuring thermal conductivity according to **ASTM C518** and **ISO 8301**. The FOX 50 provides **rapid results in a compact footprint**. The instrument is configured with the identical high performance features and proprietary technologies of the larger FOX systems including thin film heat flux transducers, digital thickness measurements, responsive temperature control, plus an integrated contact-resistance correction. Covering a wide range of temperatures, the FOX 50 is an ideal choice for measurements of medium-conductivity materials such as plastics, ceramics, glasses, composites, concrete and more.

Features

- Compact size and cost-effective system for thermal conductivity measurements
- Solid state heating/cooling for precise temperature control
- Optical encoder for the most accurate digital measurement of sample thickness
- Proprietary thin film heat flux transducers for the most representative sample heat flow measurement
- Optional liquid cell for testing of fluids.
- Powerful WinTherm-50 software for enhanced testing functionality including heat capacity.
- Optional software for specific heat measurements of solids and liquids.
- Interfacial resistance correction (two-thickness method).
- Pyrex reference standards for calibration and verification. Accurate results can be produced for years between calibrations.
- Automatic sample feeder for high-throughput analyses
- Conforms to ASTM C518 and ISO 8301

FOX 50 Specifications

Maximum Sample Thickness	25 mm (1 inch)
Temperature Range, Standard	-10 °C to 110 °C
Temperature Range, Variable Heat Sink (VHS) Model	0 °C to 190 °C
Temperature Resolution	± 0.01 °C
Thermal Conductivity Range	0.1 to 10 W/(mK) (0.633 to 60.3BTU in/hr ft ² F)
Thermal Resistance Range	0.003 to 0.05 m ² K/W
Accuracy, Standard ^[1]	± 3%
Accuracy, (VHS) ^[1]	± 4%
Reproducibility	±2%
Sample Diameter	50 mm to 62 mm (25 mm optional) ^[2]
Available Configuration	Automatic Sample Feeder Vacuum
Proprietary Thin Film Heat Flux Transducer	25 x 25 mm (10 mm dia. optional) ^[2]
Instrument Dimensions	250 mm width, 170 mm depth, 360 mm height
Instrument Weight	11Kg
Power Requirement	115V or 220V, 50/60 Hz

^[1] Two-thickness method specification

^[2] Special order, requires small transducer



FOX 600 GHP

GUARDED HOT PLATE

The FOX GHP 600 is a Guarded Hot Plate system that provides absolute thermal conductivity of insulating materials over a wide temperature range in accordance with international standard test methods ASTM C177, ISO 8302, and DIN EN 12667.

In a GHP system a temperature difference (ΔT) is established across a sample of known thickness (L). The thermal conductivity (λ) is calculated from these values and the steady state power (W) per area (A) required to maintain the temperature difference. The Guarded Hot Plate uses a direct measurement of the electrical power supplied to the hot plate. The LaserComp FOX GHP 600 is especially well-suited for thermal conductivity measurements at high temperatures, exhibiting unrivaled temperature and dimensional stability, especially for measurements from 90 °C to 250 °C.

$$\lambda = \frac{W}{A} \frac{L}{\Delta T}$$

UNITS	(W/mK) (Btu in/h ft ² F)
-------	--

$$R = \frac{1}{\lambda} L$$

UNITS	m ² K/W (h-ft ² -F/Btu)
-------	--

Features

- Single-sample design
- Outstanding temperature stability
- Superior temperature uniformity verified by 40 matched thermocouples
- Optical encoders for the most accurate digital measurement of sample thickness

• International Standard Test Methods

ASTM C177 ISO 8302 DIN EN 12667

FOX 600 GHP Specifications

Temperature Range	Ambient to 250 °C
Thermal Conductivity Range	0.0015 W/m·K to 0.35 W/m·K
Conductance	Up to 12 W/m ² ·°C
Test Configuration	Single-sample
Thickness Resolution	0.025 mm
Sample Width	610 mm square
Sample Thickness	0 to 75 mm
Temperature Stability	±0.02 °C
Accuracy	Better than 1%
Reproducibility	±0.5%



Single-Sample Advantages

The LaserComp FOX GHP 600 employs an advanced single-sample configuration that greatly enhances accuracy, is easy to use, and eliminates the requirement to produce two identical test specimens.

Vertically Directed Heat Flow - Guaranteed

Our proprietary single-sample design guarantees uniform, unidirectional heat flow. A block of insulation is placed below the Hot Plate, with a temperature-controlled heater below. The auxiliary heater employs a high-output thermopile to precisely match the lower plate temperature to the Hot Plate temperature, creating a null temperature difference eliminating heat flow in the downward direction. All heat from the Hot Plate flows upward through the sample.

Superior Temperature Stability and NO Lateral Heat Flow

Lateral heat flow is eliminated from the test specimen and all three plates in order to produce absolute thermal uniformity and truly one-dimensional heat flow. The Hot Plate is decoupled from the surroundings by an innovative low thermal conductivity fastening system.

Actively heated guard plates, gradient guards, and actively cooled heat sinks provide lateral temperature uniformity, and internal temperature stability over a wide temperature range, and despite changing laboratory conditions.

Uniform Temperature on both sample surfaces

The GHP 600 provides stable, uniform temperature control to within ± 0.02 °C through the use of 19 independently controlled heaters and 42 matched thermocouples. Signals are evaluated once per second to rapidly bring the system to the selected equilibrium test condition.

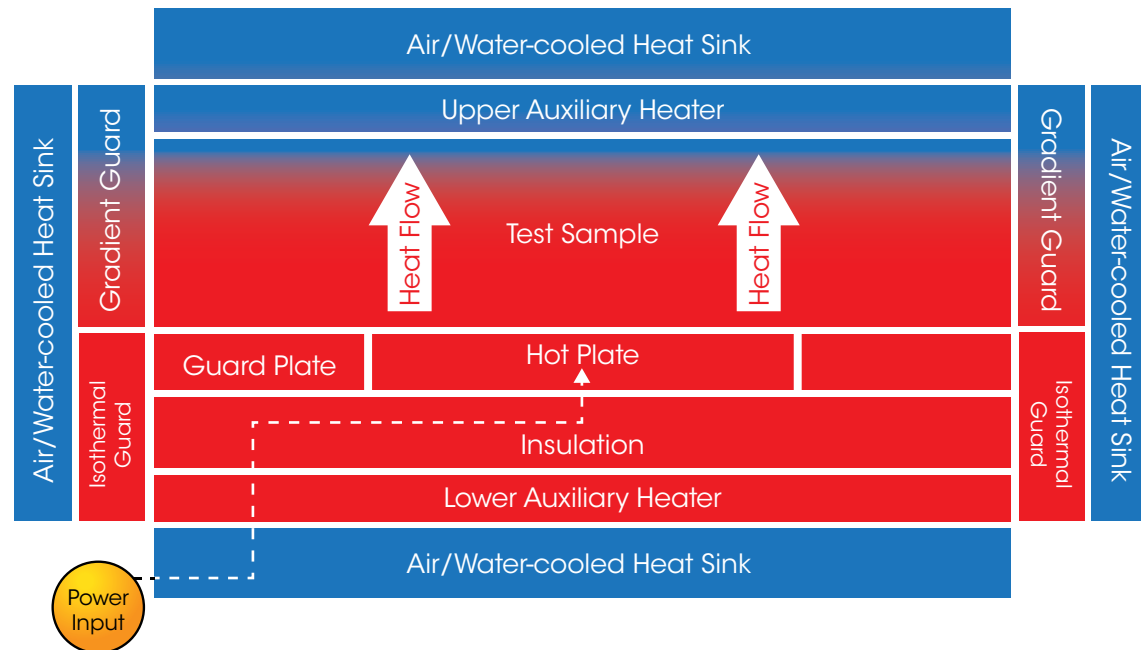

Optical Encoders deliver the most accurate measurement of sample thickness

Similar to the FOX Heat Flow Meters, the GHP features optical encoders and stepper motors for **independent position control and measurement at all four plate corners**. This gives the system the ability to level the plates to conform to samples with non-parallel surfaces, improving thermal contact and providing a truly representative measurement of sample thickness to within 25 μm .

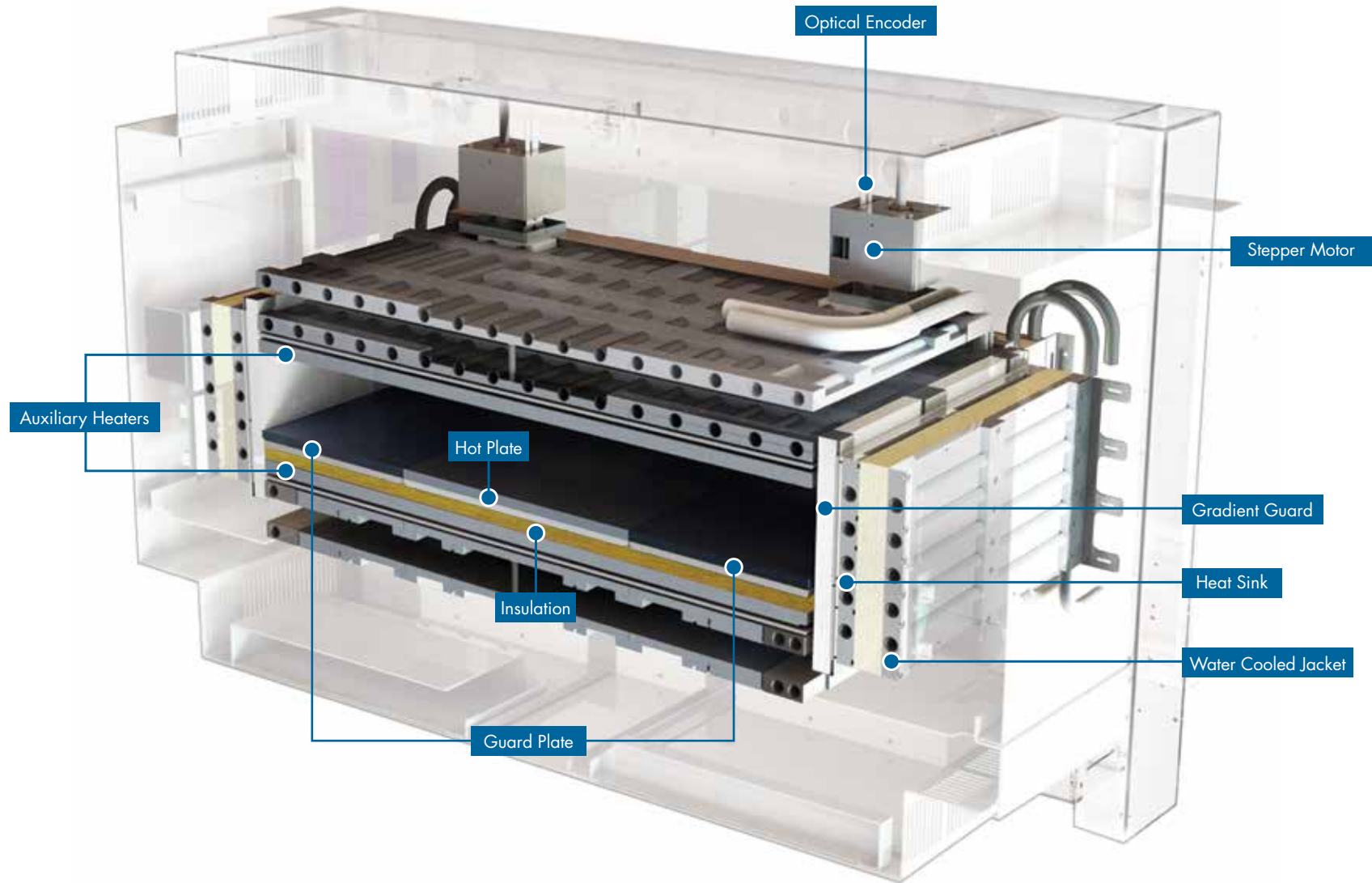

Software control and advanced features

The FOX 200, FOX 314, FOX 600, and FOX 801 systems can be operated in stand-alone mode, or connected to a PC.

Powerful software gives users the ultimate flexibility to:

- Automatically verify system performance and if necessary re-calibrate
- Control sample thickness and plate's temperatures
- View real time data
- Collect, store, and analyze data



Accelerated testing - the average heat flow of the upper and lower heat flux sensors is calculated, and stabilizes much faster than individual signals. Accurate measurements (to within +/- 0.4%) can be made in less than half the time, increasing laboratory throughput.

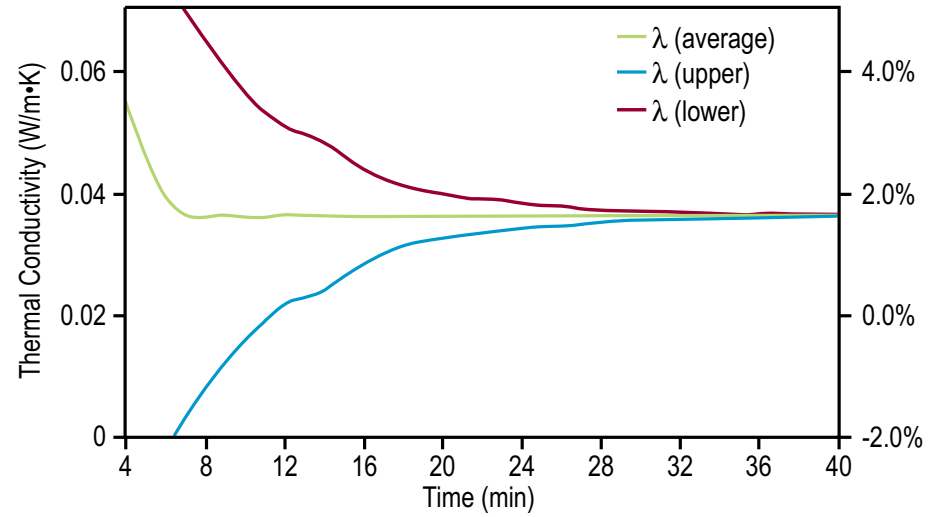

Calibrations for lateral heat loss and interface resistance. Gives users the ability to test thick samples, and materials of higher thermal conductivity.

Heat capacity - measure the volumetric specific heat and enthalpy, and detect phase changes in materials according to ASTM C1784.

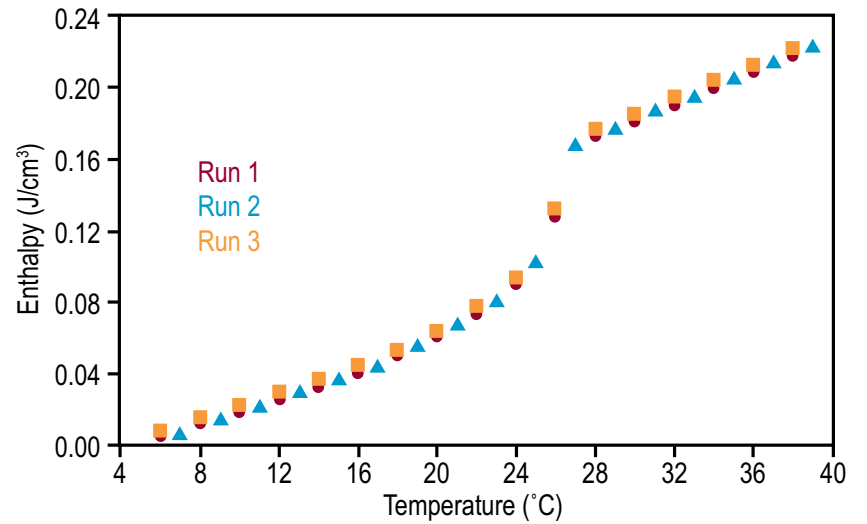
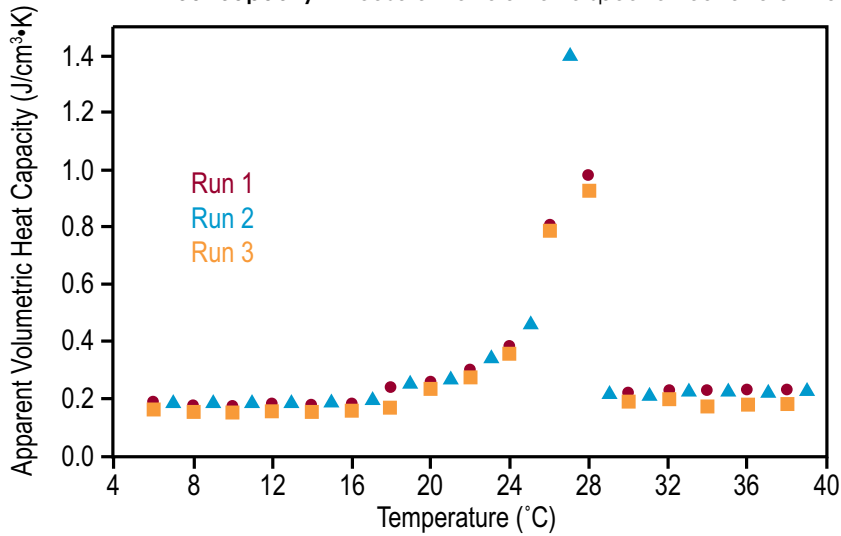

Applications

Heat Flow Meter

Rotational Testing

The total effective thermal resistance for an open-form component includes contributions from heat conduction and natural convection. Convection is dependent on installation orientation. A specimen constructed of two layers of oriented-strand board separated by two air cavities and reflective foil was tested in horizontal (0°) and vertical (90°) orientations. Both exhibit similar temperature dependence, decreasing thermal resistance with increasing temperature. The horizontal installation orientation provides 3% to 5% greater thermal resistance than the vertical orientation.

Loose Fill

Thermal conductivity depends on composition of a material, and especially on the processing or preparation of that material. In this example two different formulations of fine powder were tested for thermal conductivity using the FOX 200 Heat Flow Meter. Material 1 was prepared with the same composition, but following two different manufacturing methods, which resulted in a 20% difference in thermal conductivity. Material 2 was tested twice. The second experiment shows a markedly lower thermal conductivity than the first, indicating that the powder was impregnated with water when received and initially tested. The material dried during the first heating cycle, leading to a lower thermal conductivity on subsequent measurement.

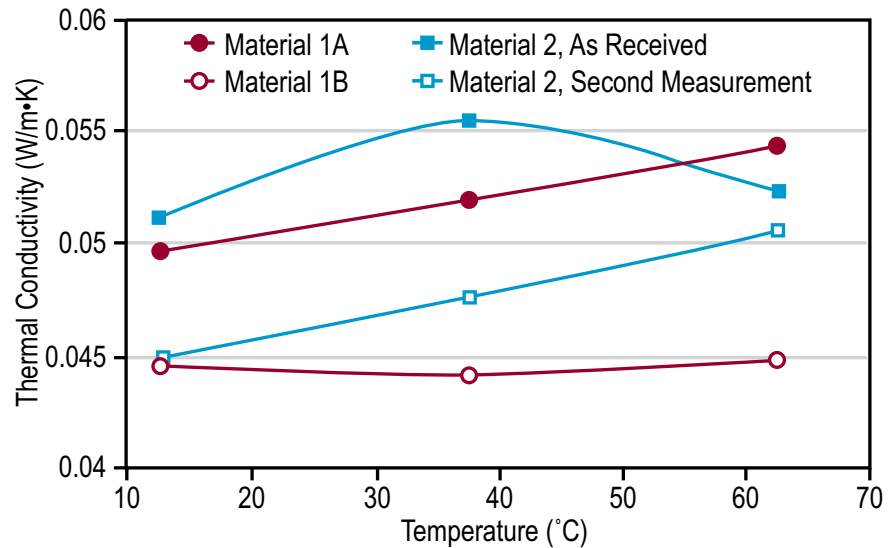
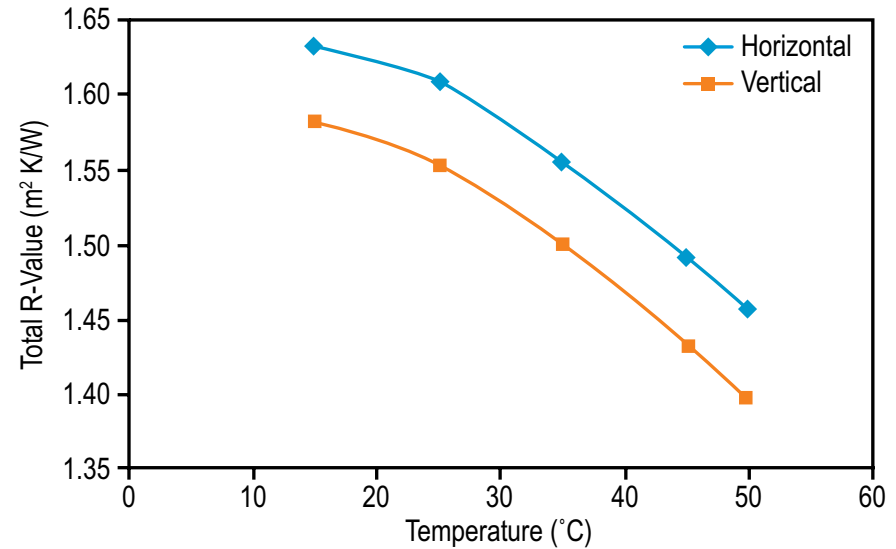

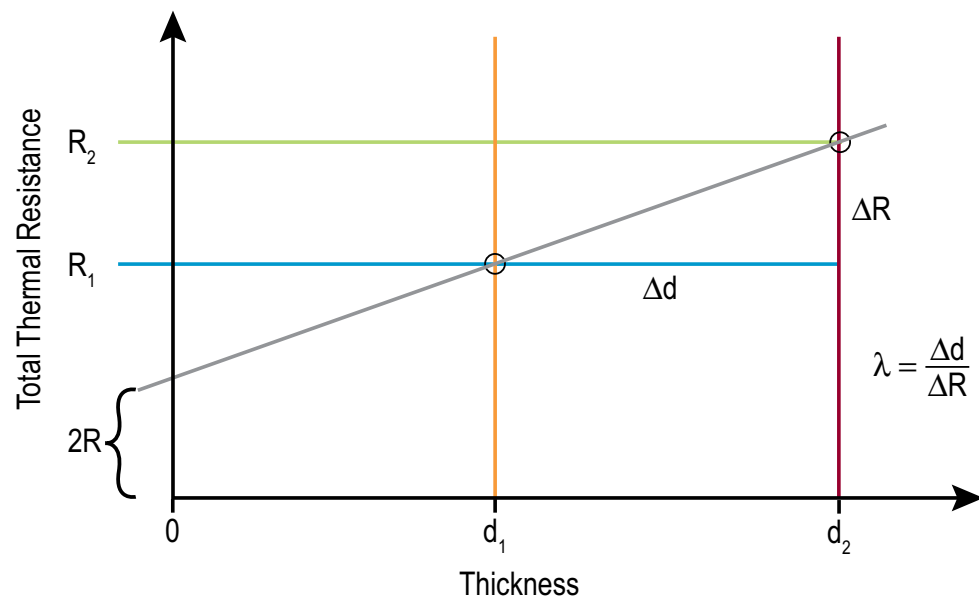

The Two-Thickness Method

The two-thickness method for thermal conductivity measurements is a powerful technique for materials that are rigid and have higher thermal conductivity values. By measuring two specimens of the same material, but different thicknesses, the thermal resistances, $2R$, that occur at the two plate/sample interfaces can be calculated and excluded.

Applications

Heat Flow Meter

Long-Term System Stability

In addition to exceptional measurement accuracy and sensitivity, the LaserComp heat flux transducer design provides unparalleled system stability. In this example, the calibration factors for a FOX 600 are shown for over 7 years. Error bars are shown at $\pm 0.5\%$. It can be seen that the calibration factor - and therefore the measured values - deviate by much less than 0.5% over the full temperature range through this very long timespan. This stability leads to greater data confidence and much less time spent calibrating as compared to competitive designs.

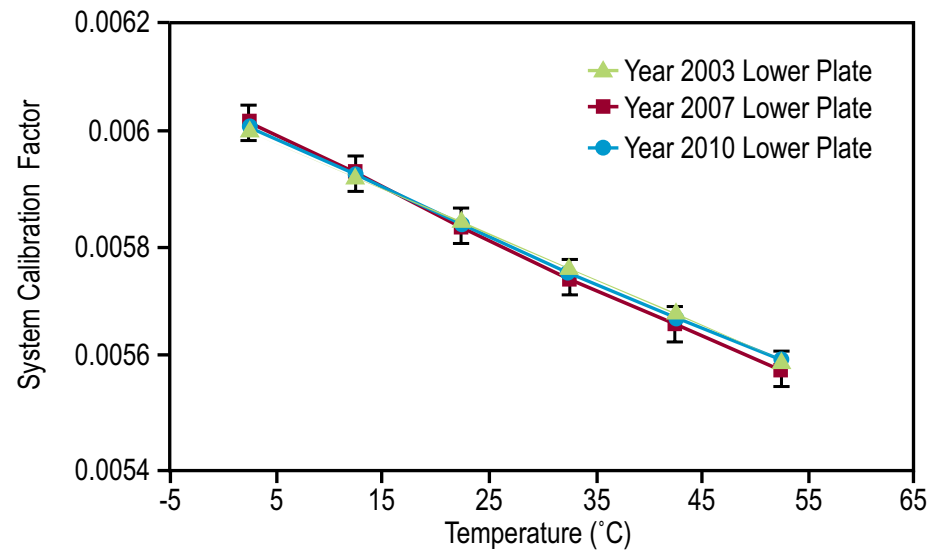

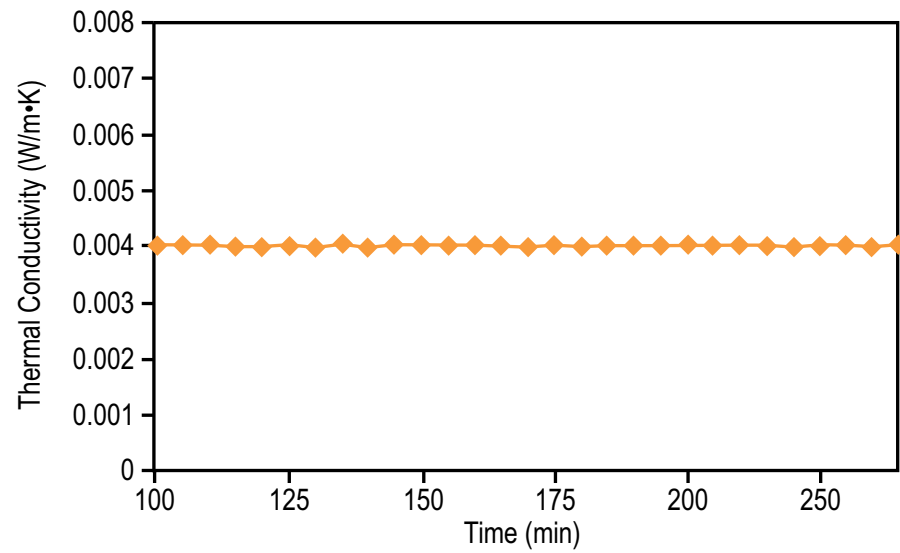

Measurement Stability

The FOX Series Heat Flow Meters exhibit both exceptional sensitivity to small heat flows, and reliable stability over the course of the measurement, free from noise or external disturbances. This example data is for a very low conductivity vacuum insulation panel tested at a mean temperature of 15 °C. The measurement is continued for more than two hours to demonstrate the stability of the measurement. The signal deviates by less than 0.2% over the course of the measurement, even for this extremely low conductivity material.



lasercomp.com