

CHEMISAFE®

SAFETY STORAGE CABINETS



COMBISTORAGE



COMBINED SAFETY STORAGE CABINETS CERTIFIED FOR HAZARDOUS PRODUCTS



**COMBINED SAFETY STORAGE CABINETS
CERTIFIED FOR HAZARDOUS PRODUCTS**

The answer to properly store and use hazardous products directly in laboratory.

- **COMBISTORAGE UNDERBENCH** to optimize spaces in laboratory.
Simply replacing the underbench standard wooden or metal cabinets, with our combined safety cabinets.
Numberless options for dimensions and typologies and hazardousness.
If ventilation is needed a vent is on the back wall for easy connection.
- **COMBISTORAGE 2, 3, 4** compartments.
To safely group all hazardous products in laboratory.



Safety underbench cabinets shall be combined on plinths with different lengths:

Plinth 1200 mm length (CSFZ120) + CS101ACSZ (600 mm) + CSF238SZ (590 mm)

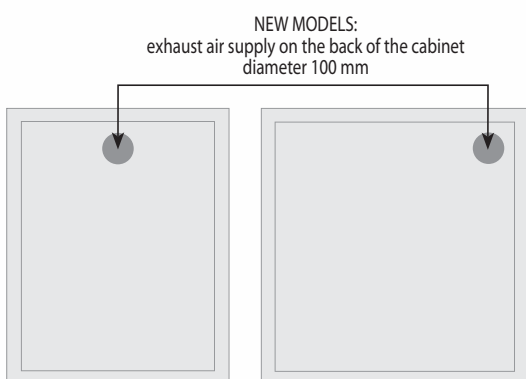

Plinth 1500 mm length (CSFZ150) + CS101ALSZ (600 mm) + CSF235CSZ (490 mm) + CS112BCSZ (400 mm)

PLINTH CODE	DIMENSIONS (WxDxH) mm
CSFZ40	400x500x80
CSFZ50	500x500x80
CSFZ60	600x500x80
CSFZ80	800x500x80
CSFZ90	900x500x80
CSFZ100	1000x500x80
CSFZ110	1100x500x80
CSFZ120	1200x500x80
CSFZ140	1400x500x80
CSFZ150	1500x500x80



Some examples of combinations on different plinths' lengths:



Plinth 800 mm length (CSFZ80) +
CS111ACSZ (400 mm) + CS112BSZ (400 mm)



Plinth 900 mm length (CSFZ90) +
CSF335CSZ (490 mm) + CS111ASZ (400 mm)



Plinth 1000 mm length (CSFZ100) +
CSF335LSZ (490 mm) + CSF235CSZ (490 mm)



Plinth 1000 mm length (CSFZ100) +
CS111ALSZ (400 mm) + CSF238CSZ (590 mm)



Plinth 1100 mm length (CSFZ110) +
CSF235LSZ (490 mm) + CS101BCSZ (600 mm)



Plinth 1200 mm length (CSFZ120) +
CSF338LSZ (590 mm) + CSF238CSZ (590 mm)



Plinth 1400 mm length (CSFZ140) +
CS112BLSZ (400 mm) + CS111ASZ (400 mm) + CSF338SZ (590 mm)















Plinth 1500 mm length (CSFZ150) +
CSF235LSZ (490 mm) + CSF235CSZ (490 mm) + CSF335SZ (490 mm)



Plinth 1500 mm length (CSFZ150) +
CS101BLSZ (600 mm) + CS111ASZ (400 mm) + CSF235CSZ (490 mm)











COMBISTORAGE UNDERBENCH FOR INFLAMMABLES TYPE 90	COMBISTORAGE UNDERBENCH FOR INFLAMMABLES TYPE 30	CODE	EXTERNAL DIMENSIONS (WxDxH) mm	INTERNAL DIMENSIONS (WxDxH) mm	No. OF ONE-LITRE BOTTLES CONTAINED IN EACH CABINET	WEIGHT (Kg)	POWDER COATED METAL SHELVES	POWDER COATED BOTTOM SUMP WITH STEEL GRID	AUTOMATIC DOORS CLOSURE WHEN TEMPERATURE > 50° C
 FIRE TYPE 90 - 490 mm Left handle	 FIRE TYPE 30 - 490 mm Left handle	CSF235SZ CSF335SZ	490x500x620	350x340x510/375	8/10	80 50	NO	YES	OPTIONAL PS50
 FIRE TYPE 90 - 490 mm Right handle	 FIRE TYPE 30 - 490 mm Right handle	CSF235LSZ CSF335LSZ	490x500x620	350x340x510/375	8/10	80 50	NO	YES	OPTIONAL PS50SX
 FIRE TYPE 90 - 490 mm Drawer	 FIRE TYPE 30 - 490 mm Drawer	CSF235CSZ CSF335CSZ	490x500x620	350x340x510/375	8/10	80 50	NO	YES	YES
 FIRE TYPE 90 - 590 mm Left handle	 FIRE TYPE 30 - 590 mm Left handle	CSF238SZ CSF338SZ	590x500x620	450x340x510/375	10/12	90 60	NO	YES	OPTIONAL PS50
 FIRE TYPE 90 - 590 mm Right handle	 FIRE TYPE 30 - 590 mm Right handle	CSF238LSZ CSF338LSZ	590x500x620	450x340x510/375	10/12	90 60	NO	YES	OPTIONAL PS50SX
 FIRE TYPE 90 - 590 mm Drawer	 FIRE TYPE 30 - 590 mm Drawer	CSF238CSZ CSF338CSZ	590x500x620	450x340x510/375	10/12	90 60	NO	YES	YES

Standard colour: Grey RAL 7035

ACIDS
INFLAMMABLE
BASE





COMBISTORAGE UNDERBENCH FOR INFLAMMABLES TYPE 90	COMBISTORAGE UNDERBENCH FOR INFLAMMABLES TYPE 30	CODE	EXTERNAL DIMENSIONS (WxDxH) mm	INTERNAL DIMENSIONS (WxDxH) mm	No. OF ONE-LITRE BOTTLES CONTAINED IN EACH CABINET	WEIGHT (Kg)	POWDER COATED METAL SHELVES	POWDER COATED BOTTOM SUMP WITH STEEL GRID	AUTOMATIC DOORS CLOSURE WHEN TEMPERATURE > 50° C
 FIRE TYPE 90 - 1000 mm	 FIRE TYPE 30 - 1000 mm	CSF231SZ CSF331SZ	1000x500x620	840x340x510/375	20/24	130 110	NO	YES	OPTIONAL PS50 + PS50SX
 FIRE TYPE 90 - 1000 mm	 FIRE TYPE 30 - 1000 mm	CSF231CSZ CSF331CSZ	1000x500x620	840x340x510/375	20/24	130 110	NO	YES	YES
 FIRE TYPE 90 - 1100 mm	 FIRE TYPE 30 - 1100 mm	CSF230SZ CSF330SZ	1100x500x620	940x340x510/375	24/30	140 120	NO	YES	OPTIONAL PS50 + PS50SX
 FIRE TYPE 90 - 1100 mm	 FIRE TYPE 30 - 1100 mm	CSF230CSZ CSF330CSZ	1100x500x620	940x340x510/375	24/30	140 120	NO	YES	YES

Standard colour: Grey RAL 7035

**BASE ACIDS
INFLAMMABLE**









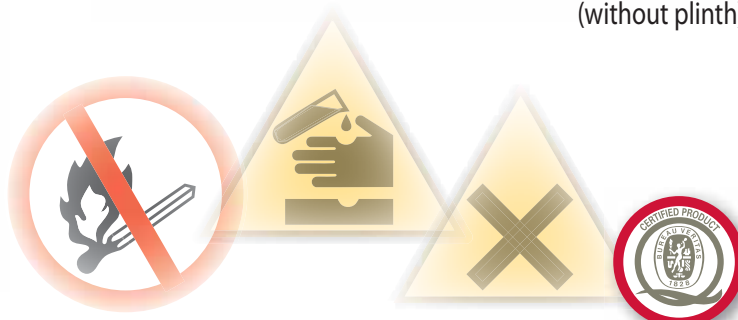





CS112BLSZ (400 mm) + CS111ALSZ (400 mm) + CSF238SZ (590 mm)
(without plinth)



Plinth 1400 mm length (CSF2140) +
CS112BLSZ (400 mm) + CS111ACSZ (400 mm) + CSF238SZ (590 mm)





COMBISTORAGE UNDERBENCH FOR ACIDS	COMBISTORAGE UNDERBENCH FOR BASES	CODE	EXTERNAL DIMENSIONS (WxDxH) mm	INTERNAL DIMENSIONS (WxDxH) mm	No. OF ONE LITRE BOTTLES CONTAINED IN EACH CABINET	WEIGHT (Kg)	POWDER COATED METAL SHELVES	POWDER COATED BOTTOM SUMP WITH STEEL GRID
 ACIDS 400 mm Left handle	 BASES 400 mm Left handle	CS111ASZ CS112BSZ	400x500x620	300x450x500	20	28	2	NO
 ACIDS 400 mm Right handle	 BASES 400 mm Right handle	CS111ALSZ CS112BLSZ	400x500x620	300x450x500	20	28	2	NO
 ACIDS 400 mm Drawer	 BASES 400 mm Drawer	CS111ACSZ CS112BCSZ	400x500x620	300x450x500	20	28	NO	YES
 ACIDS 600 mm Left handle	 BASES 600 mm Left handle	CS101ASZ CS101BSZ	600x500x620	500x450x500	40	32	2	NO
 ACIDS 600 mm Right handle	 BASES 600 mm Right handle	CS101ALSZ CS101BLSZ	600x500x620	500x450x500	40	32	2	NO
 ACIDS 600 mm Drawer	 BASES 600 mm Drawer	CS101ACSZ CS101BCSZ	600x500x620	500x450x500	40	32	NO	YES

Standard colour: Grey RAL 7035

ACIDS
INFLAMMABLE
BASE



**COMBINED SAFETY CABINET CERTIFIED
FOR THE STORAGE OF FLAMMABLE PRODUCTS,
CHEMICALS, ACIDS AND BASES**



**COMBISTORAGE 3 (CS343) +
STEP CLOSE (PS50SX) OPTIONAL**

COMBINED SAFETY CABINET CERTIFIED FOR THE STORAGE OF FLAMMABLE PRODUCTS, CHEMICALS, ACIDS, BASES AND TOXICS



COMBISTORAGE 4 (CS342) + STEP CLOSE (PS50SX) OPTIONAL

CODE	DESCRIPTION	EXTERNAL DIMENSIONS (WxDxH) mm	SHELVES - QUANTITY AND FINISH	WEIGHT (Kg)
CS343	COMBISTORAGE 3 compartments blind doors	1200x600x1950	ACIDS compartment: 2 pcs. from powder coated metal plate BASES compartment: 2 pcs. from STAINLESS STEEL plate INFLAMMABLES compartment: 3 pcs. from powder coated metal plate + 1 bottom sump with steel grid	360
CS342	COMBISTORAGE 4 compartments blind doors	1200x600x1950	ACIDS compartment: 2 pcs. from powder coated metal plate BASES compartment: 2 pcs. from STAINLESS STEEL plate TOXICS compartment: 2 pcs. from powder coated metal plate INFLAMMABLES compartment: 3 pcs. from powder coated metal plate 1 bottom sump with steel grid	380
CS344	COMBISTORAGE 4 compartments GLASS doors	1200x600x1950	ACIDS compartment: 2 pcs. from powder coated metal plate BASES compartment: 2 pcs. from STAINLESS STEEL plate TOXICS compartment: 2 pcs. from powder coated metal plate INFLAMMABLES compartment: 3 pcs. from powder coated metal plate 1 bottom sump with steel grid	380

Standard colour: Grey RAL 7035

COMBINED SAFETY CABINET CERTIFIED FOR THE STORAGE OF FLAMMABLE PRODUCTS, CHEMICALS, ACIDS, BASES AND TOXICS



COMBISTORAGE 4 (CS344) + STEP CLOSE (PS50SX) OPTIONAL

ACCESSORIES

CODE	DESCRIPTION	EXTERNAL DIMENSIONS (WxDxH) mm
CSF120	Exhaust system for C3/C4	1200x600x300
CFN	Exhaust filter/fan module according to NFX 15-211 norm	
CSAS	Activated carbon filter for solvents (for CFN)	
CSBE	Activated carbon filter for acid vapours (for CFN)	
CSMP	Activated carbon filter for acid vapours and solvents (for CFN)	
CSPF	Prefilter (for CFN)	
RIP60V	Powder coated metal shelf for C3/C4 inflammables compartment	450x385x30
RIPCS60	Powder coated metal shelf for C3/C4 Acids / toxics compartment	490x550x30
RIPX60	Stainless steel shelf for C3/C4 Bases compartment	490x550x30
PS50SX	STEP CLOSE: automatic thermal closing system when ambient temperature exceeds 50 °C	



CFN

EXHAUST FILTER/FAN MODULE ACCORDING TO NFX 15-211 NORM

COMBINED SAFETY CABINETS CERTIFIED FOR THE STORAGE OF FLAMMABLE PRODUCTS, CHEMICALS, ACIDS AND BASES



COMBISTORAGE 2 TYPE 90 (CS30090) + STEP CLOSE (PS50) OPTIONAL



COMBISTORAGE 2 TYPE 30 (CS30030) + STEP CLOSE (PS50) OPTIONAL

CODE	DESCRIPTION	EXTERNAL DIMENSIONS (WxDxH) mm	SHELVES - QUANTITY AND FINISH	WEIGHT (Kg)
CS20030	COMBISTORAGE 2 compartments: door acids & bases + door TYPE 30	600x600x1685	ACIDS & BASES compartment: 1 pce. from powder coated metal plate, 1 pce. from STAINLESS STEEL INFLAMMABLES compartment: bottom sump with steel grid	130
CS20090	COMBISTORAGE 2 compartments: door acids & bases + door TYPE 90	600x600x1685	ACIDS & BASES compartment: 1 pce. from powder coated metal plate, 1 pce. from STAINLESS STEEL INFLAMMABLES compartment: bottom sump with steel grid	140
CS20090C	COMBISTORAGE 2 compartments: door acids & bases + drawer TYPE 90	600x600x1685	ACIDS & BASES compartment: 1 pce. from powder coated metal plate, 1 pce. from STAINLESS STEEL INFLAMMABLES compartment: bottom sump with steel grid	140
CS30030	COMBISTORAGE 2 compartments: door acids & bases + door TYPE 30. With exhaust filter/fan module	600x600x1980	ACIDS & BASES compartment: 1 pce. from powder coated metal plate, 1 pce. from STAINLESS STEEL INFLAMMABLES compartment: bottom sump with steel grid	180
CS30090	COMBISTORAGE 2 compartments: door acids & bases + door TYPE 90. With exhaust filter/fan module	600x600x1980	ACIDS & BASES compartment: 1 pce. from powder coated metal plate, 1 pce. from STAINLESS STEEL INFLAMMABLES compartment: bottom sump with steel grid	190
CS30090C	COMBISTORAGE 2 compartments: door acids & bases + drawer TYPE 90. With exhaust filter/fan module	600x600x1980	ACIDS & BASES compartment: 1 pce. from powder coated metal plate, 1 pce. from STAINLESS STEEL INFLAMMABLES compartment: bottom sump with steel grid	190

Standard colour: Grey RAL 7035

COMBINED SAFETY CABINETS CERTIFIED FOR THE STORAGE OF FLAMMABLE PRODUCTS, CHEMICALS, ACIDS AND BASES



COMBISTORAGE 2 TYPE 90 (CS30090C) + STEP CLOSE included



COMBISTORAGE 2 TYPE 90 (CS20090) + STEP CLOSE (PS50) OPTIONAL

ACCESSORIES

CODE	DESCRIPTION	EXTERNAL DIMENSIONS (WxDxH) mm
CSF100	Exhaust system for C2 series 200	250x250x390
RFC60	Spare part	
CFN	Exhaust filter/fan module according to NFX 15-211 norm	
CSAS	Activated carbon filter for solvents (for CFN)	
CSBE	Activated carbon filter for acid vapours (for CFN)	
CSMP	Activated carbon filter for acid vapours and solvents (for CFN)	
CSPF	Prefilter (for CFN)	
RIPX60/C	Stainless steel shelf for Bases compartment CS20090	490x450x30
RIPCS60/C	Powder coated metal shelf for Acids compartment CS20090	490x450x30
RIP60V	Powder coated metal shelf for inflammables compartment C3/C4	450x385x30
RIPCS60	Powder coated metal shelf for Acids / toxics compartment C3/C4	490x550x30
RIPX60	Stainless steel shelf for Bases compartment C3/C4	490x550x30
PS50	STEP CLOSE: automatic thermal closing system when ambient temperature exceeds 50 °C	



CFN

EXHAUST FILTER/FAN MODULE ACCORDING TO NFX 15-211 NORM



**UNDERBENCH COMBINED SAFETY CABINETS
CERTIFIED FOR THE STORAGE OF HAZARDOUS PRODUCTS**



TECHNICAL DRAWINGS

External and internal dimensions (mm)

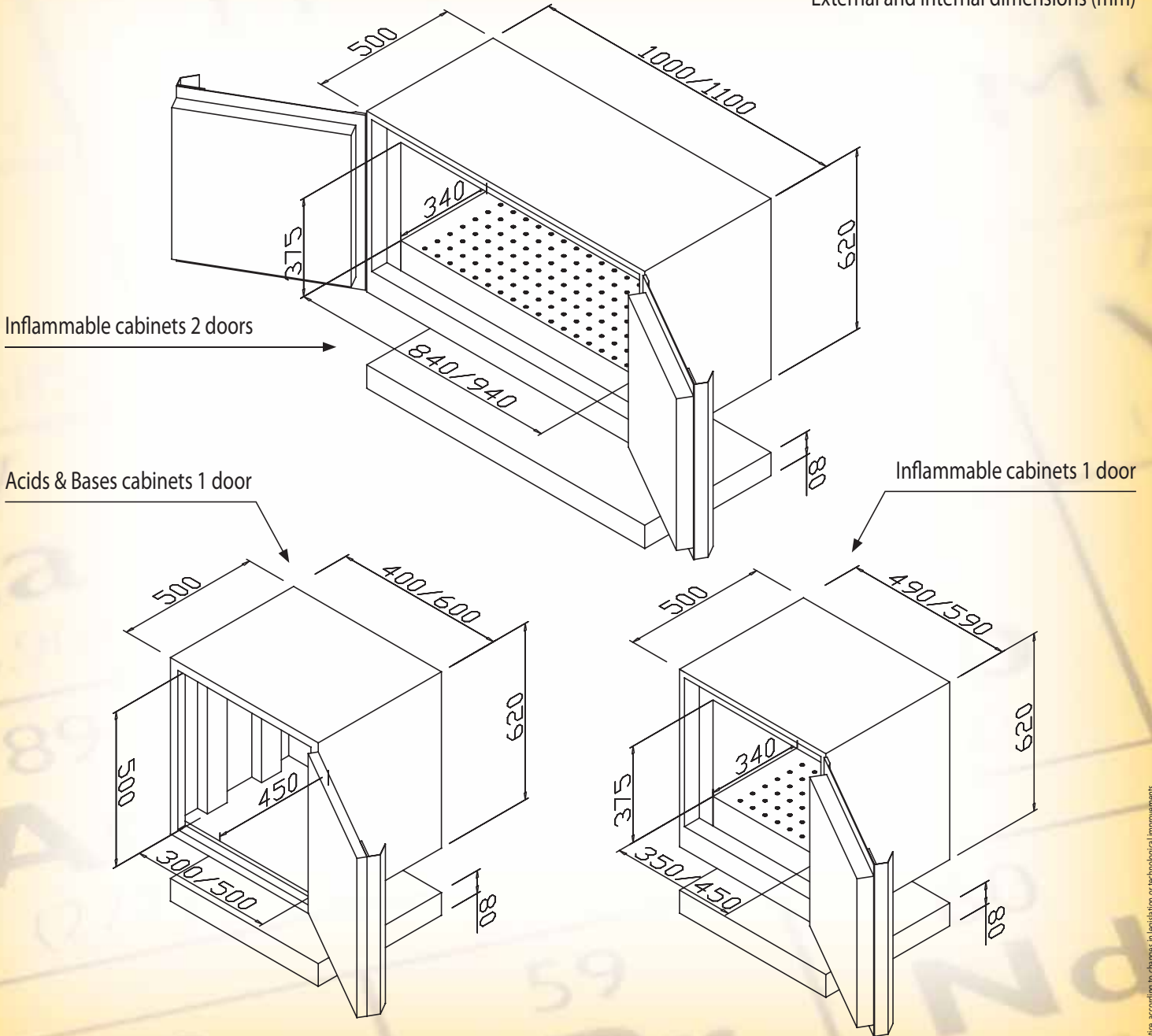

Authorized dealer: