



ORTHODONTICS®
Quality Manufacturing. Exceptional Service.

**ORTHODONTIC
PRODUCTS
CATALOG**

Volume 15



BRACKETS | **BANDS** | **TUBES** | **WIRES** | **SPRINGS** | **ELASTOMERICS**

See and order our full line of products at GHOrthodontics.com



“Quick Reorder” The easiest way yet to order products

G&H® makes reordering products a breeze with our online “Quick Reorder” feature.

- View your 2-year order history
- Reorder what you want with a few clicks
- Create or reset your login at GHOrthodontics.com

How to Order



Web Orders:
www.GHOrthodontics.com



Phone Orders:
Toll-free within the USA
and Canada
800-526-1026, or
dial +1 317-346-6655
• Our phone lines are open
Monday through Friday from
7:00 a.m. to 7:00 p.m. (EST)



Email Orders:
orders@ghortho.com



NEW!

Check out our online **Clearance Section!**

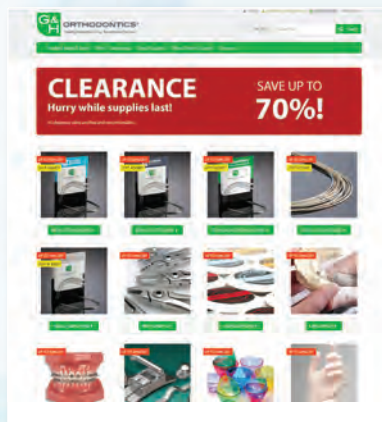

Save **BIG** on a wide selection
of products including:

- Archwires
- Gloves
- Lab Supplies
- Instruments – and more!

Save up to **70%!**

Hurry while supplies last!

GHOrthodontics.com/clearance

Our Mission – “To provide our customers a great experience achieved through quality manufacturing and exceptional service.”

GHOrthodontics.com • Toll-Free 800-526-1026 • orders@ghortho.com

Table of Contents

Brackets | Bands | Tubes 3

Metal Brackets	
miniPrevail®TWIN.....	6-10
Focus™ Bracket System.....	11-13
miniPrevail®SL.....	14-16
Agility® Self-Ligating Passive Bracket System.....	17-20
Cosmetic Brackets	
Vapor™ Ceramic Bracket System	23-26
Prism™ Composite Bracket System	27-29
Buccal Tubes	
miniPrevail®TUBE	30-31
Viper™ Low Profile Buccal Tubes	32-33
Viper™ Low Profile Mini 2nd Tube	34
Viper™ CV Low Profile Convertible Tube	35
Viper™ CV Combination Convertible Tube.....	36
Magnum™ Buccal Tubes	37-40
Bands & Attachments	
Titan™ Molar Bands	42, 43
Saturn™ Molar Bands	44, 45
Bicuspid Bands	45
Lingual Attachments.....	46

Wire Products | Springs 47

Archform Options	49, 79
Recovery Force Graphs	51-53
G4™ Nickel Titanium Archwires	55
Ultraesthetic Tooth-Colored Archwires.....	56, 67
G4orce™ Progressive Force NiTi Archwires	59
Pre-Stopped G4™ NiTi Archwires.....	57
Pre-Torqued NiTi Archwires	58
Reverse Curve NiTi Archwires	60
M5™ Thermal Nickel Titanium Archwires	62
TitanMoly™ Titanium Molybdenum Archwires.....	64
Stainless Steel Archwires.....	66
Heat-Treated Stainless Steel Archwires	68
Looped Archwires.....	69
Posted Archwires	70
Lingual Archwires.....	71-73
Australian Wire Products.....	73, 77-78
Multi-Strand Stainless Steel Archwires.....	74
Straight Lengths, Spools & Lab Wire	75
Nickel Cobalt Archwires.....	76
DYB™ Pre-Torqued Archwires	83
Springs & Auxiliaries	
G4™ Nickel Titanium Closed Coil Springs	86-87
G4™ NiTi TAD Springs.....	86
Open and Closed Coil Springs	87
Stainless Steel Open and Closed Coil Springs.....	87
Crimpable Hooks and Stops.....	88
Palatal Arch Bars.....	88
Expansion Screws	89

Elastomeric Products 90

Elastomeric Ligature Ties.....	91
Latex Elastics/Non-Latex Elastics.....	91-99
Elastics Color Display®.....	92
DesignerTies®	93
Elastomeric Chain	94-95
Elastomeric Separators.....	96
Elastic Thread/Tubing	98
Private Logo Elastics.....	99

Clinical Supplies..... 100

Bonding Supplies	
Aligner Support Products	101
Reliance Bonding Products	101-107
Mixing Tips & Brushes.....	105
Mixing Pads, Wells, Dappen Dishes.....	107
Saliva Ejectors/Oral Evacuators	108
Retractors.....	109
SmartBond® Wet Field Bonding Adhesive.....	110
Curing Light (LEDEX™).....	111
Mini-Mold™ Kit & Bite Bumpers	112
Extraoral & Finishing	
Fiber Reinforced Composite, Lingual Retention.....	113
Neosmile™ Tooth Positioner.....	114
Protraction Face Masks	115
Facebows & Lip Bumpers.....	116
Neckpads, Headcaps, Storage Cases	117
Instruments	
Pliers, Cutters, Wire Forming, Bracket Removal	118-120
Hand Instruments.....	121-123
Instrument Holders/Racks.....	124
Handpieces.....	126
Prophy Supplies.....	126-127
Burs, Abrasive Wheels, Stones	128-131
Impression/Disposables	
Impression Trays/Supplies	132-136
Plaster, Model Formers, Stone Material.....	137
Photographic Mirrors, Hand Mirrors	138
Cups, Headrest/Chair Covers.....	140
Gloves, Face Masks.....	143-144
X-Ray Film, Chemistry	145-146
Lab Supplies	
Utility Wax.....	147
Retainer Material/Plastics	148
Solder.....	148
Hygienic/Cleaners	
Disinfecting Towelettes	149
General Purpose Cleaners	149-151
Sterilants, Ultrasonic Cleaners.....	150-151
Sterilization Pouches.....	151-152
Cotton Rolls, Gauze	152-153
Hand Soap, Lotion, Paper Towels.....	153-154
Eye Protection.....	154
Bio-hazard/Sharps Containers	155
Barrier Film	155
Equipment	
Sandblast/Grinding Containment	156-157
Etchers & Supplies.....	157
Micromotors.....	157
Vibrators.....	157
Plaster Traps.....	158
Vacuum Formers.....	158

Patient Supplies..... 159

For the Patient	
Retainer Cases, Mouth Guards	160-161
Floss, Toothbrushes.....	162-163
Patient Relief Wax.....	162-164
Elastic Placement Tool/Storage Cases.....	165

INTRODUCING the miniPrevail® family of **BRACKETS & TUBES**

As the world's best manufacturer of premium archwires, G&H knows the integral role that brackets & tubes play in harmonizing successful treatment. Our new line of miniPrevail® brackets and tubes were engineered to perform seamlessly with our premium archwires and elastomers.



NEW!

miniPrevail® SL

SELF-LIGATING BRACKET SYSTEM

The newest member of the miniPrevail® family from G&H®

**The answer to achieve excellent,
predictable treatment results in less time.**

(See page 14)

miniPrevail® TWIN

Precision Manufactured By G&H® Orthodontics

**A true miniature twin bracket system that
incorporates all the benefits of a larger bracket**

(See page 6)



NEW!

miniPrevail® TUBE

Precision Manufactured By G&H® Orthodontics

**Seamlessly working together
with our miniPrevail® TWIN**

(See page 30)

Brackets | Bands | Tubes



Precision engineered and manufactured with a focus on performance and patient comfort.



G&H® MANUFACTURES ALL CLINICAL/INTRAORAL PRODUCT GROUPS

ARCHWIRES

G4™ NITI, S3™ STAINLESS, & TITANMOLY
TITANIUM MOLYBDENUM ARCHWIRES



As the world's best manufacturer of premium archwires, G&H knows the integral role the archwire plays in achieving successful clinical outcomes.

Nickel titanium, page 55
Titanium molybdenum, page 65
Stainless Steel, page 66

BRACKETS

METAL INJECTION MOLDED MINIPREVAIL®TWIN BRACKETS



miniPrevail®TWIN brackets are constructed of a specialized micro-grain stainless steel MIM powder, ideal for creating small, robust appliances that are inherently stronger and more dimensionally accurate than other similar brackets.

miniPrevail®TWIN brackets, page 6

ELASTOMERIC

BAMBINO™ TIES, ELASTOMERIC LIGATURE TIES



Our Bambino™ ties offer a softer feel for positive engagement and allow retention to any size bracket. Available in 33 colors.

Bambino™ Ties, page 91

DYNALINK™ ELASTOMERIC CHAIN



Our Dyna-link™ chain provides gentle, predictable tooth movement with superior memory and rebound. Available in 3 spacing variations and in 33 colors.

Dyna-Link™ Chain, page 94

G&H Precision Manufactured

Contemporary Clinical Bracket Systems



Learn More

View our miniPrevail®TWIN bracket video and patient cases.

Visit [GHOrthodontics.com/miniPrevailtwin](https://www.GHOrthodontics.com/miniPrevailtwin)

miniPrevail® TWIN

Precision Manufactured By G&H® Orthodontics

A POWERFUL COMFORTABLE BRACKET SYSTEM

A true miniature twin bracket system that incorporates all the benefits of a larger bracket

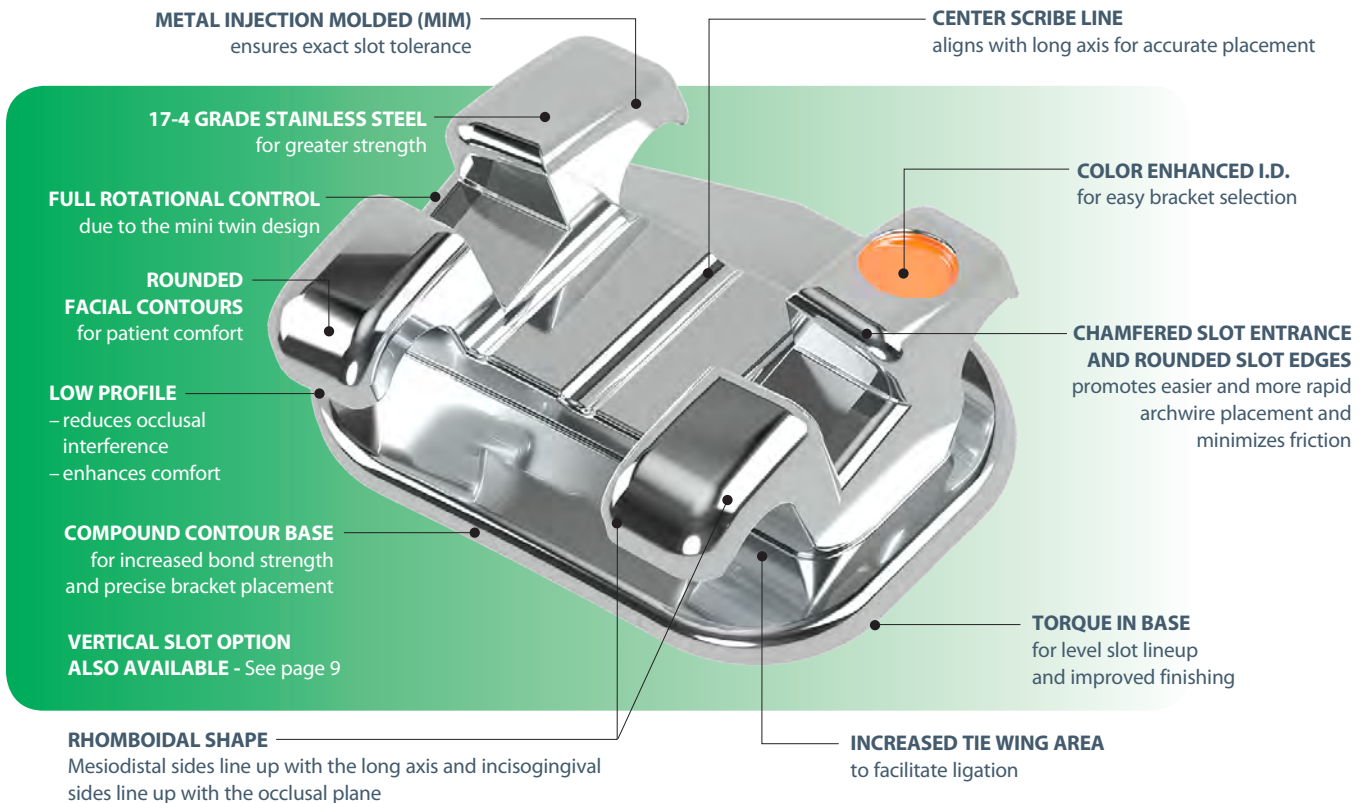

A Mini Twin with all the features of a full twin

miniPrevail brackets are constructed of a specialized micro-grain stainless steel MIM powder, ideal for creating small, robust appliances that are inherently stronger and more dimensionally accurate than other similar brackets.



80 Gauge Mesh Bonding Base

Matches the anatomy of the tooth for maximum contact and a strong, consistent bond. The miniPrevail® bracket is also designed with torque-in-base to provide level slot lineup and help avoid occlusal interference.



Learn More -

View our miniPrevail® product video and patient cases -
GHOrthodontics.com/miniPrevailtwin



Learn More -
View our miniPrevail®TWIN product video and patient cases - GHOrthodontics.com/miniPrevailtwin

TOP SELLER!

miniPrevail®TWIN Bracket Kits

20 brackets per kit – upper & lower 5-5

Mesh Base

.018

.022

Offset Bicuspid Mesh Base Option

.018

.022

Roth™ Rx

Upper/Lower 5x5 Hook on 3	36K-3-18-01	36K-3-22-01	36KO-3-18-01	36KO-3-22-01
Upper/Lower 5x5 Hook on 3, 4, & 5	36K-345-18-01	36K-345-22-01	36KO-345-18-01	36KO-345-22-01

Roth™ Rx V-Slot

Upper/Lower 5x5 Hook on 3	38K-3-18-01	38K-3-22-01	38KO-3-18-01	38KO-3-22-01
Upper/Lower 5x5 Hook on 3, 4, & 5	38K-345-18-01	38K-345-22-01	38KO-345-18-01	38KO-345-22-01

MBT™ Rx

Upper/Lower 5x5 Hook on 3	37K-3-18-01	37K-3-22-01	37KO-3-18-01	37KO-3-22-01
Upper/Lower 5x5 Hook on 3, 4, & 5	37K-345-18-01	37K-345-22-01	37KO-345-18-01	37KO-345-22-01

MBT Rx kits include 0° torque on the cuspids - custom kits available upon request.

Brackets are packaged with 1 case oriented in a kit box.

Brackets are also available as kits in bags.

Brackets are also available in kits of 5 or 10 cases oriented in a carousel dispenser.



miniPrevail®TWIN bracket kit, 20 brackets oriented in a kit box



Bracket kits are also available in kits of 5 or 10 cases oriented in a carousel dispenser.

miniPrevail®TWIN Bracket Identification

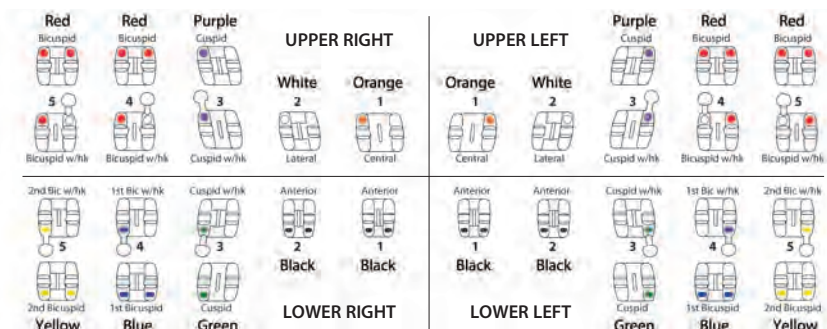

**MBT is a trademark of 3M Unitek Corporation.

°G&H® prescriptions are not implied to be an exact version of any other system, nor do we claim any endorsement by the doctor.



Individual brackets by tooth

Maxillary Roth° Rx

Tooth	Torque	Angle	Rotation	M/D	R/L	ID	Mesh Base		Offset Bicuspid Mesh Base Option	
							.018	.022	.018	.022
Central	12°	5°	0°	.140"	R L	● ●	36-U1-8R 36-U1-8L	36-U1-2R 36-U1-2L	—	—
Central Hi-Torque	22°	5°	0°	.140"	R L	● ●	39-U1-8R 39-U1-8L	39-U1-2R 39-U1-2L	—	—
Lateral	8°	9°	0°	.115"	R L	○ ○	36-U2-8R 36-U2-8L	36-U2-2R 36-U2-2L	—	—
Lateral Hi-Torque	14°	9°	0°	.115"	R L	○ ○	39-U2-8R 39-U2-8L	39-U2-2R 39-U2-2L	—	—
Cuspid (without Hook)	0°	11°	0°	.122"	R L	● ●	36-U3-8R 36-U3-8L	36-U3-2R 36-U3-2L	—	—
Cuspid Hk (with Hook)	0°	11°	0°	.122"	R L	● ●	36-U3-8RK 36-U3-8LK	36-U3-2RK 36-U3-2LK	—	—
Bicuspid	-7°	0°	0°	.122"	U	●●	36-U4-8U	36-U4-2U	36-U4-8UO	36-U4-2UO
Bicuspid Hk	-7°	0°	0°	.122"	R L	● ●	36-U4-8RK 36-U4-8LK	36-U4-2RK 36-U4-2LK	36-U4-8RKO 36-U4-8LKO	36-U4-2RKO 36-U4-2LKO

Mandibular Roth° Rx

Tooth	Torque	Angle	Rotation	M/D	R/L	ID	Mesh Base		Offset Bicuspid Mesh Base Option	
							.018	.022	.018	.022
Anterior	0°	0°	0°	.100"	U	●●	36-L1-8U	36-L1-2U	—	—
Cuspid (without Hook)	-11°	5°	0°	.122"	R L	● ●	36-L3-8R 36-L3-8L	36-L3-2R 36-L3-2L	—	—
Cuspid Hk (with Hook)	-11°	5°	0°	.122"	R L	● ●	36-L3-8RK 36-L3-8LK	36-L3-2RK 36-L3-2LK	—	—
1 st Bicuspid	-17°	0°	0°	.122"	U	●●	36-L4-8U	36-L4-2U	36-L4-8UO	36-L4-2UO
1 st Bicuspid Hk	-17°	0°	0°	.122"	R L	● ●	36-L4-8RK 36-L4-8LK	36-L4-2RK 36-L4-2LK	36-L4-8RKO 36-L4-8LKO	36-L4-2RKO 36-L4-2LKO
2 nd Bicuspid	-22°	0°	0°	.122"	U	●●	36-L5-8U	36-L5-2U	36-L5-8UO	36-L5-2UO
2 nd Bicuspid Hk	-22°	0°	0°	.122"	R L	● ●	36-L5-8RK 36-L5-8LK	36-L5-2RK 36-L5-2LK	36-L5-8RKO 36-L5-8LKO	36-L5-2RKO 36-L5-2LKO

Bracket Kits Roth° Rx

20 brackets per kit	Mesh Base		Offset Bicuspid Mesh Base Option	
	.018	.022	.018	.022
Upper/Lower 5x5 Hook on 3	36K-3-18-01	36K-3-22-01	36KO-3-18-01	36KO-3-22-01
Upper/Lower 5x5 Hook on 3, 4, & 5	36K-345-18-01	36K-345-22-01	36KO-345-18-01	36KO-345-22-01

Brackets are packaged with 1 case oriented in a kit box.
 Brackets are also available as kits in bags.
 Brackets are also available in kits of 5 or 10 cases oriented in a carousel dispenser.



miniPrevail®TWIN bracket kit, 20 brackets oriented in a kit box



Bracket kits are also available in kits of 5 or 10 cases in a carousel dispenser.

**MBT is a trademark of 3M Unitek Corporation.

°°G&H® prescriptions are not implied to be an exact version of any other system, nor do we claim any endorsement by the doctor.

miniPrevail®TWIN Brackets Precision Manufactured By G&H® Orthodontics

TOP SELLER!

Individual brackets by tooth



Roth® V-Slot Prescription – Vertical slot measures .018x.018

Maxillary Roth® Rx V-Slot

Mesh Base

Offset Bicuspid Mesh Base Option

Tooth	Torque	Angle	Rotation	M/D	R/L	ID	.018	.022	.018	.022
Central	12°	5°	0°	.140"	R L	● ●	38-U1-8R 38-U1-8L	38-U1-2R 38-U1-2L	–	–
Lateral	8°	9°	0°	.115"	R L	○ ○	38-U2-8R 38-U2-8L	38-U2-2R 38-U2-2L	–	–
Cuspid (without Hook)	0°	11°	0°	.122"	R L	● ●	38-U3-8R 38-U3-8L	38-U3-2R 38-U3-2L	–	–
Cuspid Hk (with Hook)	0°	11°	0°	.122"	R L	● ●	38-U3-8RK 38-U3-8LK	38-U3-2RK 38-U3-2LK	–	–
Bicuspid	-7°	0°	0°	.122"	U	●●	38-U4-8U	38-U4-2U	38-U4-8UO	38-U4-2UO
Bicuspid Hk	-7°	0°	0°	.122"	R L	● ●	38-U4-8RK 38-U4-8LK	38-U4-2RK 38-U4-2LK	38-U4-8RKO 38-U4-8LKO	38-U4-2RKO 38-U4-2LKO

Mandibular Roth® Rx V-Slot

Mesh Base

Offset Bicuspid Mesh Base Option

Tooth	Torque	Angle	Rotation	M/D	R/L	ID	.018	.022	.018	.022
Anterior	0°	0°	0°	.100"	U	●●	38-L1-8U	38-L1-2U	–	–
Cuspid (without Hook)	-11°	5°	0°	.122"	R L	● ●	38-L3-8R 38-L3-8L	38-L3-2R 38-L3-2L	–	–
Cuspid Hk (with Hook)	-11°	5°	0°	.122"	R L	● ●	38-L3-8RK 38-L3-8LK	38-L3-2RK 38-L3-2LK	–	–
1 st Bicuspid	-17°	0°	0°	.122"	U	●●	38-L4-8U	38-L4-2U	38-L4-8UO	38-L4-2UO
1 st Bicuspid Hk	-17°	0°	0°	.122"	R L	● ●	38-L4-8RK 38-L4-8LK	38-L4-2RK 38-L4-2LK	38-L4-8RKO 38-L4-8LKO	38-L4-2RKO 38-L4-2LKO
2 nd Bicuspid	-22°	0°	0°	.122"	U	●●	38-L5-8U	38-L5-2U	38-L5-8UO	38-L5-2UO
2 nd Bicuspid Hk	-22°	0°	0°	.122"	R L	● ●	38-L5-8RK 38-L5-8LK	38-L5-2RK 38-L5-2LK	38-L5-8RKO 38-L5-8LKO	38-L5-2RKO 38-L5-2LKO

Bracket Kits Roth® Rx V-Slot

Mesh Base

Offset Bicuspid Mesh Base Option

20 brackets per kit	.018	.022	.018	.022
Upper/Lower 5x5 Hook on 3	38K-3-18-01	38K-3-22-01	38KO-3-18-01	38KO-3-22-01
Upper/Lower 5x5 Hook on 3, 4, & 5	38K-345-18-01	38K-345-22-01	38KO-345-18-01	38KO-345-22-01

Brackets are packaged with 1 case oriented in a kit box.

Brackets are also available as kits in bags.

Brackets are also available in kits of 5 or 10 cases oriented in a carousel dispenser.



miniPrevail®TWIN bracket kit, 20 brackets oriented in a kit box



Bracket kits are also available in kits of 5 or 10 cases in a carousel dispenser.

**MBT is a trademark of 3M Unitek Corporation.

°G&H® prescriptions are not implied to be an exact version of any other system, nor do we claim any endorsement by the doctor.

miniPrevail®TWIN Brackets Precision Manufactured By G&H® Orthodontics

TOP SELLER!



Individual brackets by tooth

Maxillary MBT** Rx

Tooth	Torque	Angle	Rotation	M/D	R/L	ID	Mesh Base		Offset Bicuspid Mesh Base Option	
							.018	.022	.018	.022
Central	17°	4°	0°	.140"	R L	● ●	37-U1-8R 37-U1-8L	37-U1-2R 37-U1-2L	-	-
Lateral	10°	8°	0°	.115"	R L	○ ○	37-U2-8R 37-U2-8L	37-U2-2R 37-U2-2L	-	-
Cuspid (without Hook)	-7°	8°	0°	.122"	R L	● ●	37-U3-8R 37-U3-8L	37-U3-2R 37-U3-2L	-	-
Cuspid Hk (with Hook)	-7°	8°	0°	.122"	R L	● ●	37-U3-8RK 37-U3-8LK	37-U3-2RK 37-U3-2LK	-	-
Cuspid (without Hook)	0°	0°	.122"	R L	● ●	37-U3-8R0 37-U3-8L0	37-U3-2R0 37-U3-2L0	-	-	
Cuspid Hk (with Hook)	0°	8°	0°	.122"	R L	● ●	37-U3-8RK0 37-U3-8LK0	37-U3-2RK0 37-U3-2LK0	-	-
Bicuspid	-7°	0°	0°	.122"	U	●●	37-U4-8U	37-U4-2U	37-U4-8UO	37-U4-2UO
Bicuspid Hk	-7°	0°	0°	.122"	R L	● ●	37-U4-8RK 37-U4-8LK	37-U4-2RK 37-U4-2LK	37-U4-8RK0 37-U4-8LK0	37-U4-2RK0 37-U4-2LK0

Mandibular MBT** Rx

Tooth	Torque	Angle	Rotation	M/D	R/L	ID	Mesh Base		Offset Bicuspid Mesh Base Option	
							.018	.022	.018	.022
Anterior	-6°	0°	0°	.100"	U	●●	37-L1-8U	37-L1-2U	-	-
Cuspid (without Hook)	-6°	3°	0°	.122"	R L	● ●	37-L3-8R 37-L3-8L	37-L3-2R 37-L3-2L	-	-
Cuspid Hk (with Hook)	-6°	3°	0°	.122"	R L	● ●	37-L3-8RK 37-L3-8LK	37-L3-2RK 37-L3-2LK	-	-
Cuspid (without Hook)	0°	3°	0°	.122"	R L	● ●	37-L3-8R0 37-L3-8L0	37-L3-2R0 37-L3-2L0	-	-
Cuspid Hk (with Hook)	0°	3°	0°	.122"	R L	● ●	37-L3-8RK0 37-L3-8LK0	37-L3-2RK0 37-L3-2LK0	-	-
1 st Bicuspid	-12°	0°	0°	.122"	U	●●	37-L4-8U	37-L4-2U	37-L4-8UO	37-L4-2UO
1 st Bicuspid Hk	-12°	0°	0°	.122"	R L	● ●	37-L4-8RK 37-L4-8LK	37-L4-2RK 37-L4-2LK	37-L4-8RK0 37-L4-8LK0	37-L4-2RK0 37-L4-2LK0
2 nd Bicuspid	-17°	0°	0°	.122"	U	●●	37-L5-8U	37-L5-2U	37-L5-8UO	37-L4-2UO
2 nd Bicuspid Hk	-17°	0°	0°	.122"	R L	● ●	37-L5-8RK 37-L5-8LK	37-L5-2RK 37-L5-2LK	37-L5-8RK0 37-L5-8LK0	37-L5-2RK0 37-L5-2LK0

Bracket Kits MBT** Rx

20 brackets per kit	Mesh Base		Offset Bicuspid Mesh Base Option	
	.018	.022	.018	.022
Upper/Lower 5x5 Hook on 3	37K-3-18-01	37K-3-22-01	37KO-3-18-01	37KO-3-22-01
Upper/Lower 5x5 Hook on 3, 4, & 5	37K-345-18-01	37K-345-22-01	37KO-345-18-01	37KO-345-22-01

MBT Rx kits include 0° torque on the cuspids - custom kits available upon request.
 Brackets are packaged with 1 case oriented in a kit box.
 Brackets are also available in kits of 5 or 10 cases oriented in a carousel dispenser.
 Brackets are also available as kits in bags.



miniPrevail®TWIN bracket kit, 20 brackets oriented in a kit box



Bracket kits are also available in kits of 5 or 10 cases in a carousel dispenser.

**MBT is a trademark of 3M Unitek Corporation.

°G&H® prescriptions are not implied to be an exact version of any other system, nor do we claim any endorsement by the doctor.

Focus™ BRACKET SYSTEM

Precision Manufactured By G&H® Orthodontics

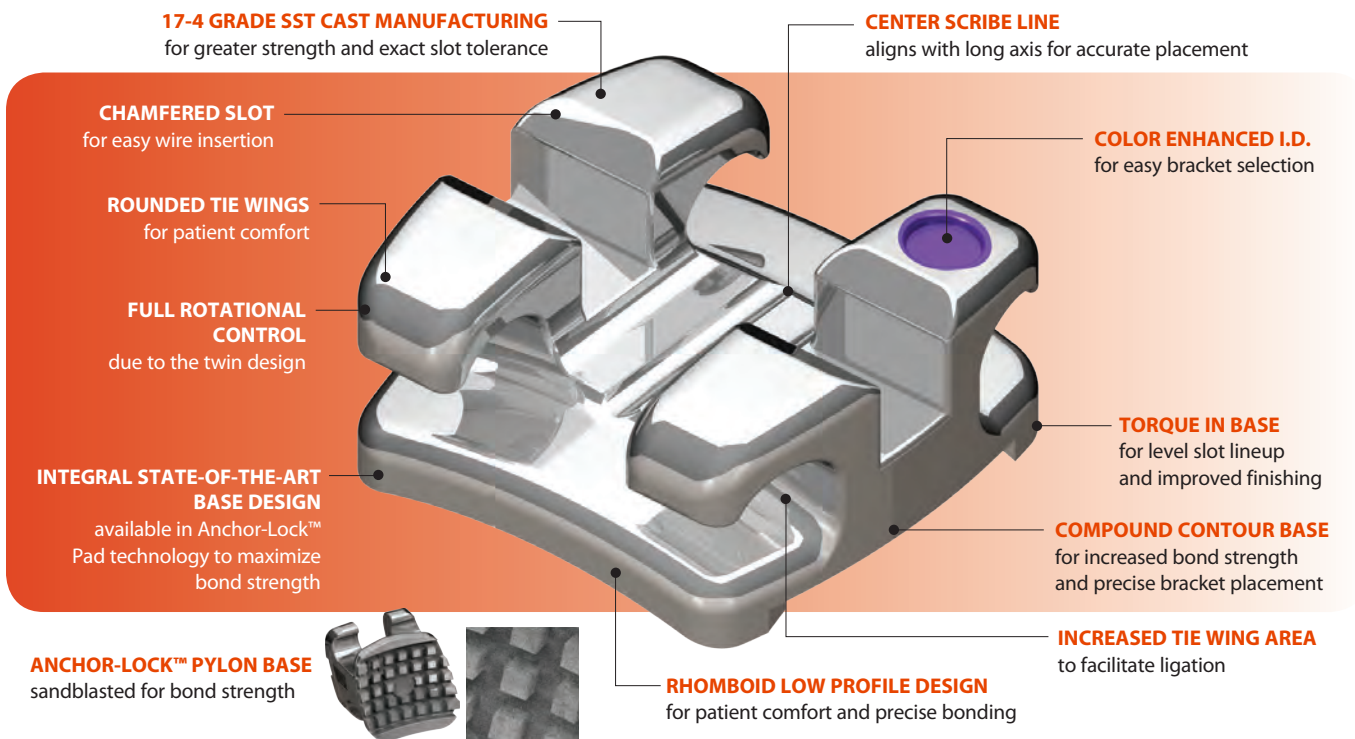

Focus™ Bracket Kits

20 brackets per kit – upper & lower 5-5

Anchor-Lock Base

Patient Kits - Roth™ Rx	.018	.022
Upper/Lower 5x5 Hook on 3	19K-3-18-01	19K-3-22-01
Upper/Lower 5x5 Hook on 3, 4, & 5	19K-345-18-01	19K-345-22-01
Patient Kits - MBT™ Rx	.018	.022
Upper/Lower 5x5 Hook on 3	21K-3-18-01	21K-3-22-01
Upper/Lower 5x5 Hook on 3, 4, & 5	21K-345-18-01	21K-345-22-01



Focus™ Bracket kit, 20 brackets oriented in a kit box



Bracket kits are also available in kits of 5 or 10 cases in a carousel dispenser.

MBT Rx kits include 0° torque on the cuspid - custom kits available upon request.
Brackets are packaged with 1 case oriented in a kit box.
Brackets are also available in kits of 5 or 10 cases oriented in a carousel dispenser.
Brackets are also available as kits in bags.

Focus™ Bracket Identification

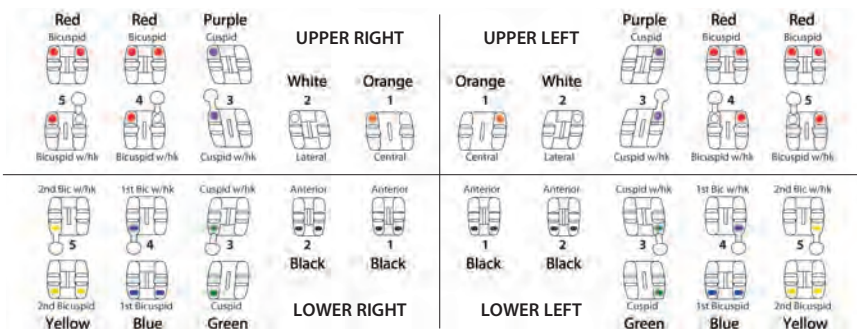

Focus™ Brackets Precision Manufactured By G&H® Orthodontics



Individual brackets by tooth

Maxillary Roth® Rx

Anchor-Lock Base

Tooth	Torque	Angle	Rotation	M/D	R/L	ID	.018	.022
Central	12°	5°	0°	3.9 mm	R L	● ●	19-U1-8R 19-U1-8L	19-U1-2R 19-U1-2L
Lateral	8°	9°	0°	3.3 mm	R L	○ ○	19-U2-8R 19-U2-8L	19-U2-2R 19-U2-2L
Cuspid (without Hook)	0°	11°	0°	3.4 mm	R L	● ●	19-U3-8R 19-U3-8L	19-U3-2R 19-U3-2L
Cuspid Hk (with Hook)	0°	11°	0°	3.4 mm	R L	● ●	19-U3-8RK 19-U3-8LK	19-U3-2RK 19-U3-2LK
1 st & 2 nd Bicuspid	-7°	0°	0°	3.4 mm	U	●●	19-U4-8U	19-U4-2U
1 st & 2 nd Bicuspid Hk	-7°	0°	0°	3.4 mm	R L	● ●	19-U4-8RK 19-U4-8LK	19-U4-2RK 19-U4-2LK

Mandibular Roth® Rx

Anchor-Lock Base

Tooth	Torque	Angle	Rotation	M/D	R/L	ID	.018	.022
Anterior	0°	0°	0°	2.6 mm	U	●●	19-L1-8U	19-L1-2U
Cuspid (without Hook)	-11°	5°	0°	3.4 mm	R L	● ●	19-L3-8R 19-L3-8L	19-L3-2R 19-L3-2L
Cuspid Hk (with Hook)	-11°	5°	0°	3.4 mm	R L	● ●	19-L3-8RK 19-L3-8LK	19-L3-2RK 19-L3-2LK
1 st Bicuspid	-17°	0°	0°	3.4 mm	U	●●	19-L4-8U	19-L4-2U
1 st Bicuspid Hk	-17°	0°	0°	3.4 mm	R L	● ●	19-L4-8RK 19-L4-8LK	19-L4-2RK 19-L4-2LK
2 nd Bicuspid	-22°	0°	0°	3.4 mm	U	●●	19-L5-8U	19-L5-2U
2 nd Bicuspid Hk	-22°	0°	0°	3.4 mm	R L	● ●	19-L5-8RK 19-L5-8LK	19-L5-2RK 19-L5-2LK

Bracket Kits Roth® Rx

20 brackets per kit	.018	.022
Upper/Lower 5x5 Hook on 3	19K-3-18-01	19K-3-22-01
Upper/Lower 5x5 Hook on 3, 4, & 5	19K-345-18-01	19K-345-22-01

Brackets are packaged with 1 case oriented in a kit box.
 Brackets are also available as kits in bags.
 Brackets are also available in kits of 5 or 10 cases oriented in a carousel dispenser.



Focus™ Bracket kit, 20 brackets oriented in a kit box



Bracket kits are also available in kits of 5 or 10 cases in a carousel dispenser.

**MBT is a trademark of 3M Unitek Corporation.

®G&H® prescriptions are not implied to be an exact version of any other system, nor do we claim any endorsement by the doctor.

Focus™ Brackets Precision Manufactured By G&H® Orthodontics

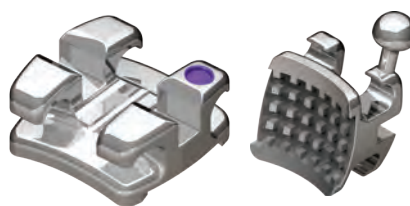

Individual brackets by tooth

Maxillary MBT** Rx

Anchor-Lock Base

Tooth	Torque	Angle	Rotation	M/D	R/L	ID	.018	.022
Central	17°	4°	0°	3.9 mm	R L	● ●	21-U1-8R 21-U1-8L	21-U1-2R 21-U1-2L
Lateral	10°	8°	0°	3.3 mm	R L	○ ○	21-U2-8R 21-U2-8L	21-U2-2R 21-U2-2L
Cuspid (without Hook)	-7°	8°	0°	3.4 mm	R L	○ ●	21-U3-8R 21-U3-8L	21-U3-2R 21-U3-2L
Cuspid Hk (with Hook)	-7°	8°	0°	3.4 mm	R L	● ●	21-U3-8RK 21-U3-8LK	21-U3-2RK 21-U3-2LK
Cuspid (without Hook)	0°	8°	0°	3.4 mm	R L	● ●	21-U3-8R0 21-U3-8L0	21-U3-2R0 21-U3-2L0
Cuspid Hk (with Hook)	0°	8°	0°	3.4 mm	R L	● ●	21-U3-8RK0 21-U3-8LK0	21-U3-2RK0 21-U3-2LK0
1 st & 2 nd Bicuspid	-7°	0°	0°	3.4 mm	U	●●	21-U4-8U	21-U4-2U
1 st & 2 nd Bicuspid Hk	-7°	0°	0°	3.4 mm	R L	● ●	21-U4-8RK 21-U4-8LK	21-U4-2RK 21-U4-2LK

Mandibular MBT** Rx

Anchor-Lock Base

Tooth	Torque	Angle	Rotation	M/D	R/L	ID	.018	.022
Anterior	-6°	0°	0°	2.6 mm	U	●●	21-L1-8U	21-L1-2U
Cuspid (without Hook)	-6°	3°	0°	3.4 mm	R L	● ●	21-L3-8R 21-L3-8L	21-L3-2R 21-L3-2L
Cuspid Hk (with Hook)	-6°	3°	0°	3.4 mm	R L	● ●	21-L3-8RK 21-L3-8LK	21-L3-2RK 21-L3-2LK
Cuspid (without Hook)	0°	3°	0°	3.4 mm	R L	● ●	21-L3-8R0 21-L3-8L0	21-L3-2R0 21-L3-2L0
Cuspid Hk (with Hook)	0°	3°	0°	3.4 mm	R L	● ●	21-L3-8RK0 21-L3-8LK0	21-L3-2RK0 21-L3-2LK0
1 st Bicuspid	-12°	0°	0°	3.4 mm	U	●●	21-L4-8U	21-L4-2U
1 st Bicuspid Hk	-12°	0°	0°	3.4 mm	R L	● ●	21-L4-8RK 21-L4-8LK	21-L4-2RK 21-L4-2LK
2 nd Bicuspid	-17°	0°	0°	3.4 mm	U	●●	21-L5-8U	21-L5-2U
2 nd Bicuspid Hk	-17°	0°	0°	3.4 mm	R L	● ●	21-L5-8RK 21-L5-8LK	21-L5-2RK 21-L5-2LK

Bracket Kits MBT** Rx

Anchor-Lock Base

20 brackets per kit	.018	.022
Upper/Lower 5x5 Hook on 3	21K-3-18-01	21K-3-22-01
Upper/Lower 5x5 Hook on 3, 4, & 5	21K-345-18-01	21K-345-22-01

MBT Rx kits include 0° torque on the cuspids - custom kits available upon request.
 Brackets are packaged with 1 case oriented in a kit box.
 Brackets are also available as kits in bags.
 Brackets are also available in kits of 5 or 10 cases oriented in a carousel dispenser.



Focus™ Bracket kit, 20 brackets oriented in a kit box



Bracket kits are also available in kits of 5 or 10 cases in a carousel dispenser.

**MBT is a trademark of 3M Unitek Corporation.

°G&H® prescriptions are not implied to be an exact version of any other system, nor do we claim any endorsement by the doctor.

INTRODUCING -

NEW!

miniPrevail[®] SL

SELF-LIGATING BRACKET SYSTEM

The newest member of the miniPrevail[®] family from G&H[®]

The answer to achieve excellent, predictable treatment results in less time.

An **INTERACTIVE** self ligating bracket which uses a NiTi spring clip that is strong enough to deliver continuous and consistent forces while assuring tooth movement control. When using round archwires (up to .020") allows **PASSIVE** engagement during initial leveling and alignment to reduce friction and improve sliding mechanics. When using rectangular archwires (from .016" x .022"), becomes **ACTIVE** to provide effective torque and rotation control toward the end of treatment.

METAL INJECTION MOLDED (MIM)

micro-grain stainless steel powder ensures exact tolerances and strength of design

FULL ROTATIONAL CONTROL

due to the mini twin design

LOW PROFILE

- reduces occlusal interference
- enhances comfort

COMPOUND CONTOUR BASE

for increased bond strength and precise bracket placement

17-4 SURGICAL-GRADE STAINLESS STEEL
for greater strength

COLOR ENHANCED I.D.
for easy bracket selection

NITI SPRING CLIP
for maximum resistance to permanent deformation, durability, and stable performance - prevents unwanted opening, yet opens easily with an explorer, closes with gentle finger pressure

AMPLE TIE WING
for elastomeric chain and ties

FULL SLOT AREA COVERAGE
for total tooth movement control

ASSEMBLED USING LASER TECHNOLOGY

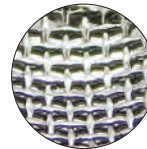
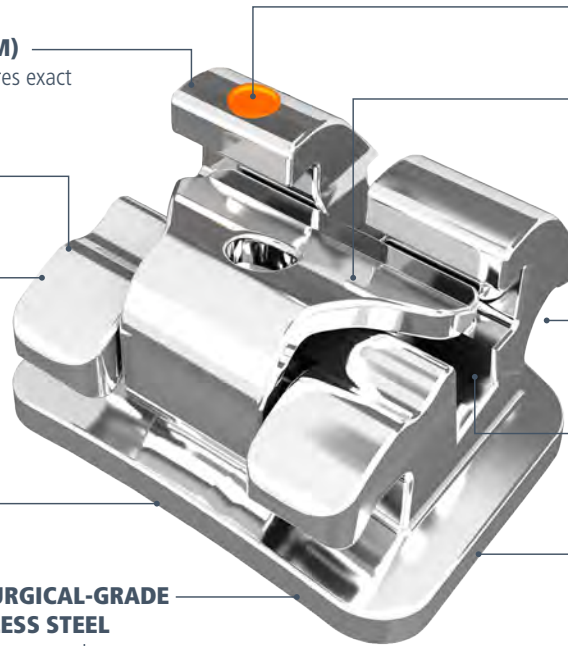

80 GAUGE ANATOMICAL BONDING BASE
matches the anatomical curvature of the tooth for maximum contact and a strong, consistent bond

miniPrevail[®] SL Bracket Kits	Mesh Base
20 brackets per kit – upper & lower 5-5	.018 .022

Roth[™] Rx

Upper/Lower 5x5 Hook on 3, 4, & 5	120K-345-18-01	120K-345-22-01
-----------------------------------	----------------	----------------

MBT[™] Rx

Upper/Lower 5x5 Hook on 3, 4, & 5	-	121K-345-22-01
-----------------------------------	---	----------------



Brackets are packaged with 1 case (20 brackets) oriented in a kit box. Brackets are also available as kits in bags.

miniPrevail[®] SL Bracket Identification Roth[™] Rx

<p>Red Bicuspid</p> <p>Red Bicuspid</p> <p>Purple Cuspid</p>	<p>UPPER RIGHT</p> <p>White Lateral</p> <p>Orange Central</p>	<p>UPPER LEFT</p> <p>White Central</p> <p>Orange Lateral</p>	<p>Purple Cuspid</p> <p>Red Bicuspid</p> <p>Red Bicuspid</p>
<p>2nd Bic w/hk</p> <p>1st Bic w/hk</p> <p>Cuspid w/hk</p>	<p>Anterior</p> <p>Anterior</p> <p>Black</p>	<p>Anterior</p> <p>Anterior</p> <p>Black</p>	<p>Cuspid w/hk</p> <p>1st Bic w/hk</p> <p>2nd Bic w/hk</p>
<p>2nd Bicuspid</p> <p>1st Bicuspid</p> <p>Cuspid</p>	<p>LOWER RIGHT</p> <p>Yellow</p> <p>Blue</p> <p>Green</p>	<p>LOWER LEFT</p> <p>Green</p> <p>Blue</p> <p>Yellow</p>	<p>Cuspid</p> <p>1st Bicuspid</p> <p>2nd Bicuspid</p>

miniPrevail[®] SL Bracket Identification MBT[™] Rx

<p>Red Bicuspid</p> <p>Red Bicuspid</p> <p>Purple Cuspid</p>	<p>UPPER RIGHT</p> <p>White Lateral</p> <p>Orange Central</p>	<p>UPPER LEFT</p> <p>White Central</p> <p>Orange Lateral</p>	<p>Purple Cuspid</p> <p>Red Bicuspid</p> <p>Red Bicuspid</p>
<p>2nd Bic w/hk</p> <p>1st Bic w/hk</p> <p>Cuspid w/hk</p>	<p>Anterior</p> <p>Anterior</p> <p>Black</p>	<p>Anterior</p> <p>Anterior</p> <p>Black</p>	<p>Cuspid w/hk</p> <p>1st Bic w/hk</p> <p>2nd Bic w/hk</p>
<p>2nd Bicuspid</p> <p>1st Bicuspid</p> <p>Cuspid</p>	<p>LOWER RIGHT</p> <p>Yellow</p> <p>Blue</p> <p>Green</p>	<p>LOWER LEFT</p> <p>Green</p> <p>Blue</p> <p>Yellow</p>	<p>Cuspid</p> <p>1st Bicuspid</p> <p>2nd Bicuspid</p>

**MBT is a trademark of 3M Unitek Corporation.

°G&H[®] prescriptions are not implied to be an exact version of any other system, nor do we claim any endorsement by the doctor.

miniPrevail®SL – Interactive SLB



Individual brackets by tooth

Maxillary Roth° Rx

Mesh Base

Tooth	Torque	Angle	Rotation	M/D	R/L	ID	.018	.022
Central	12°	5°	0°	.124"	R L	● ●	120-U1-8RV 120-U1-8LV	120-U1-2RV 120-U1-2LV
Lateral	8°	9°	0°	.106"	R L	○ ○	120-U2-8RV 120-U2-8LV	120-U2-2RV 120-U2-2LV
Cuspid	-2°	11°	0°	.110"	R L	● ●	120-U3-8RV 120-U3-8LV	120-U3-2RV 120-U3-2LV
Cuspid Hk (with Hook)	-2°	11°	0°	.110"	R L	● ●	120-U3-8RKV 120-U3-8LKV	120-U3-2RKV 120-U3-2LKV
Bicuspid	-7°	0°	0°	.110"	U	●●	120-U4-8UV	120-U4-2UV
Bicuspid Hk	-7°	0°	0°	.110"	R L	● ●	120-U4-8RKV 120-U4-8LKV	120-U4-2RKV 120-U4-2LKV

Mandibular Roth° Rx

Mesh Base

Tooth	Torque	Angle	Rotation	M/D	R/L	ID	.018	.022
Anterior	-1°	0°	0°	.098"	U	●●	120-L1-8UV	120-L1-2UV
Cuspid	-11°	7°	0°	.110"	R L	● ●	120-L3-8RV 120-L3-8LV	120-L3-2RV 120-L3-2LV
Cuspid Hk (with Hook)	-11°	7°	0°	.110"	R L	● ●	120-L3-8RKV 120-L3-8LKV	120-L3-2RKV 120-L3-2LKV
1 st Bicuspid	-17°	0°	0°	.110"	U	●●	120-L4-8UV	120-L4-2UV
1 st Bicuspid Hk	-17°	0°	0°	.110"	R L	● ●	120-L4-8RKV 120-L4-8LKV	120-L4-2RKV 120-L4-2LKV
2 nd Bicuspid	-22°	0°	0°	.110"	U	●●	120-L5-8UV	120-L5-2UV
2 nd Bicuspid Hk	-22°	0°	0°	.110"	R L	● ●	120-L5-8RKV 120-L5-8LKV	120-L5-2RKV 120-L5-2LKV

Bracket Kits Roth° Rx

Mesh Base

20 brackets per kit	.018	.022
Upper/Lower 5x5 Hook on 3, 4, & 5	120K-345-18-01	120K-345-22-01

Brackets are packaged with 1 case (20 brackets) oriented in a kit box.
Brackets are also available in 5 case kits (100 brackets) in bags.



Brackets are packaged with 1 case (20 brackets) oriented in a kit box.
Brackets are also available as kits in bags.

**MBT is a trademark of 3M Unitek Corporation.

°°G&H° prescriptions are not implied to be an exact version of any other system, nor do we claim any endorsement by the doctor.

miniPrevail®SL – Interactive SLB

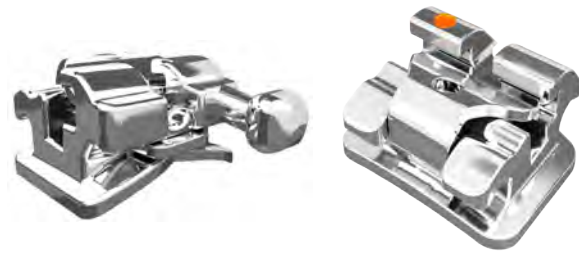

Individual brackets by tooth

Maxillary MBT** Rx

Mesh Base

Tooth	Torque	Angle	Rotation	M/D	R/L	ID	.022
Central	17°	4°	0°	.124"	R L	● ●	121-U1-2RV 121-U1-2LV
Lateral	10°	8°	0°	.106"	R L	○ ○	121-U2-2RV 121-U2-2LV
Cuspid	-7°	8°	0°	.110"	R L	● ●	121-U3-2RV 121-U3-2LV
Cuspid Hk (with Hook)	-7°	8°	0°	.110"	R L	● ●	121-U3-2RKV 121-U3-2LKV
Bicuspid	-7°	0°	0°	.110"	U	●●	121-U4-2UV
Bicuspid Hk (with Hook)	-7°	0°	0°	.110"	R L	● ●	121-U4-2RKV 121-U4-2LKV

Mandibular MBT** Rx

Mesh Base

Tooth	Torque	Angle	Rotation	M/D	R/L	ID	.022
Anterior	-6°	0°	0°	.098"	U	●●	121-L1-2UV
Cuspid	-6°	3°	0°	.110"	R L	● ●	121-L3-2RV 121-L3-2LV
Cuspid Hk (with Hook)	-6°	3°	0°	.110"	R L	● ●	121-L3-2RKV 121-L3-2LKV
1 st Bicuspid	-12°	2°	0°	.110"	R L	● ●	121-L4-2RV 121-L4-2LV
1 st Bicuspid Hk (with Hook)	-12°	2°	0°	.110"	R L	● ●	121-L4-2RKV 121-L4-2LKV
2 nd Bicuspid	-17°	2°	0°	.110"	R L	● ●	121-L5-2RV 121-L5-2LV
2 nd Bicuspid Hk (with Hook)	-17°	2°	0°	.110"	R L	● ●	121-L5-2RKV 121-L5-2LKV

Bracket Kits MBT** Rx

Mesh Base

20 brackets per kit	.022
Upper/Lower 5x5 Hook on 3, 4, & 5	121K-345-22-01

Brackets are packaged with 1 case (20 brackets) oriented in a kit box.
Brackets are also available in 5 case kits (100 brackets) in bags.



Brackets are packaged with 1 case (20 brackets) oriented in a kit box.
Brackets are also available as kits in bags.

**MBT is a trademark of 3M Unitek Corporation.

°G&H® prescriptions are not implied to be an exact version of any other system, nor do we claim any endorsement by the doctor.

AGILITY[®]

SELF-LIGATING BRACKET SYSTEM

Precision Manufactured By G&H[®] Orthodontics

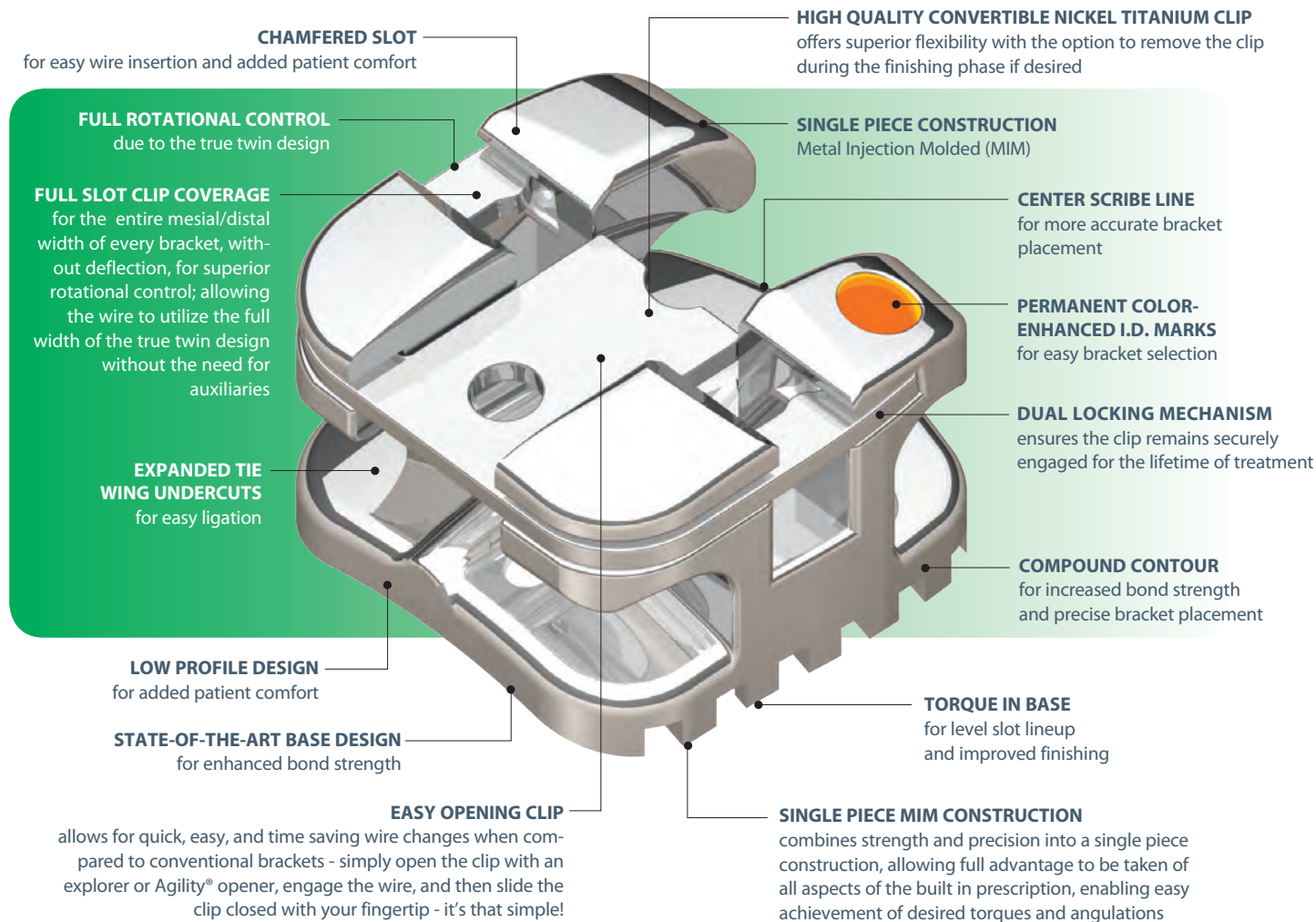

Agility[™] Bracket Kits

20 brackets per kit – upper & lower 5-5

Anchor-Lock Base

Patient Kits - Roth [™] Rx	.018	.022
Upper/Lower 5x5 Hook on 3	15K-3-18-01	15K-3-22-01
Upper/Lower 5x5 Hook on 3, 4, & 5	15K-345-18-01	15K-345-22-01
Patient Kits - MBT [™] Rx	.018	.022
Upper/Lower 5x5 Hook on 3	14K-3-18-01	14K-3-22-01
Upper/Lower 5x5 Hook on 3, 4, & 5	14K-345-18-01	14K-345-22-01

MBT Rx kits include 0° torque on the cusps - custom kits available upon request.
 Brackets are packaged with 1 case oriented in a kit box.
 Brackets are also available in kits of 5 or 10 cases oriented in a carousel dispenser.
 Brackets are also available as kits in bags.



Agility[®] Bracket kit, 20 brackets oriented in a kit box



Bracket kits are also available in kits of 5 or 10 cases in a carousel dispenser.

**MBT is a trademark of 3M Unitek Corporation.

°°G&H[®] prescriptions are not implied to be an exact version of any other system, nor do we claim any endorsement by the doctor.

Agility® Self-Ligating Brackets Precision Manufactured By G&H® Orthodontics

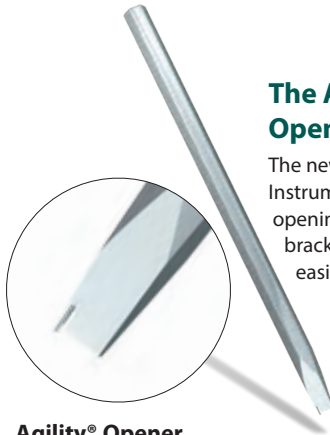

Agility® Opener
Each **ISP-001**

The Agility® Opener

The new Agility® Instrument makes opening the bracket even easier.

Recommended Opening Technique - Agility® Opener

Opening the clip of the Agility® bracket is a snap! The first “click” you hear will be the clip disengaging from the top lock, and the second “click,” assures you the clip is fully open.



Simply insert the round engagement pin, located on the beveled edge of the opener, into the lumen on the clip.



Rotate the opener until the side of the beveled edge contacts the tip of the tie wing, making sure the pin stays in the lumen.



Continue to rotate the opener, using the tie wing as a leverage point, until the clip disengages. Then pull the clip towards the incisal until the clip is fully open.



Optional Convertible Clip

The clips can be easily removed during the finishing phase, allowing the use of ligatures to secure the archwire into the slot.

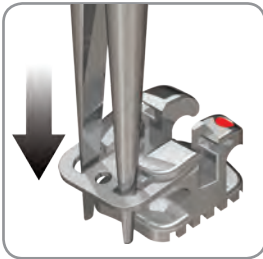

To convert, simply insert the ends of a tweezer between the mesial/distal grooves.

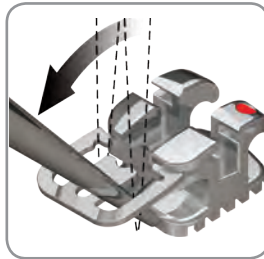

Rotate the tweezer towards the incisal in a 45° motion, gently easing the clip open.

Alternate Opening Techniques

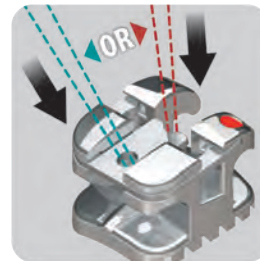

Place the tip of an explorer **1** into the clip's easily accessible circular opening or **2** at the end of the clip's alignment guide.

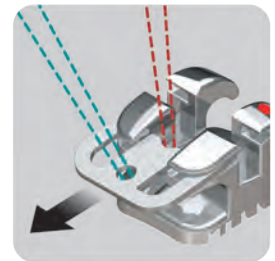

1 or **2** Pull the explorer towards the incisal to open the clip.

Closing Technique

Closing the Agility® clip is even easier.

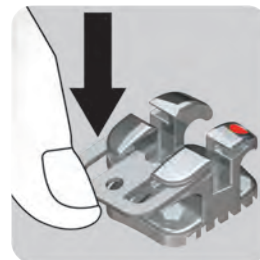

Using a utility plier, a tweezer, or even your own fingertip, gently apply pressure to the occlusal side of the clip to slide closed.

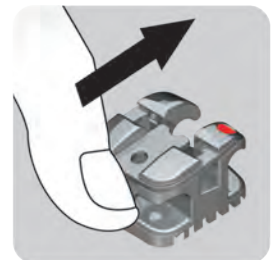

When the clip begins to close, it will “click” once as it disengages from the bottom lock, and will then “click” a second time to indicate it is fully closed.

Agility® Bracket Identification

UPPER RIGHT					UPPER LEFT				
Red Bicuspid w/whk	Red Bicuspid w/whk	Purple Cuspid w/whk	White Lateral	Orange Central	Orange Central	White Lateral	Purple Cuspid w/whk	Red Bicuspid w/whk	Red Bicuspid w/whk
2nd Bicuspid w/whk	1st Bicuspid w/whk	Cuspid w/whk	Anterior	Anterior	Anterior	Anterior	Cuspid w/whk	1st Bicuspid w/whk	2nd Bicuspid w/whk
Yellow	Blue	Green	Black	Black	Black	Black	Green	Blue	Yellow
LOWER RIGHT					LOWER LEFT				

Agility® Self-Ligating Brackets Precision Manufactured By G&H® Orthodontics

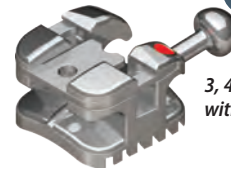

3, 4 and 5s available with or without hooks

Individual brackets by tooth

Maxillary Roth[®] Rx

Anchor-Lock Base

Tooth	Torque	Angle	Rotation	M/D	R/L	ID	.018	.022
Central	12°	5°	0°	3.5 mm	R	●	15-U1-8R	15-U1-2R
					L	●	15-U1-8L	15-U1-2L
Lateral	8°	9°	0°	3.0 mm	R	○	15-U2-8R	15-U2-2R
					L	○	15-U2-8L	15-U2-2L
Cuspid (without Hook)	0°	11°	0°	3.3mm	R	●	15-U3-8R	15-U3-2R
					L	●	15-U3-8L	15-U3-2L
Cuspid Hk (with Hook)	0°	11°	0°	3.3mm	R	●	15-U3-8RK	15-U3-2RK
					L	●	15-U3-8LK	15-U3-2LK
1 st & 2 nd Bicuspid	-7°	0°	2°	3.0 mm	R	●	15-U4-8R	15-U4-2R
					L	●	15-U4-8L	15-U4-2L
1 st & 2 nd Bicuspid Hk	-7°	0°	2°	3.0 mm	R	●	15-U4-8RK	15-U4-2RK
					L	●	15-U4-8LK	15-U4-2LK

Mandibular Roth[®] Rx

Anchor-Lock Base

Tooth	Torque	Angle	Rotation	M/D	R/L	ID	.018	.022
Anterior	0°	0°	0°	2.5 mm	U	●●	15-L1-8U	15-L1-2U
Cuspid (without Hook)	-11°	5°	0°	3.0 mm	R	●	15-L3-8R	15-L3-2R
					L	●	15-L3-8L	15-L3-2L
Cuspid Hk (with Hook)	-11°	5°	0°	3.0 mm	R	●	15-L3-8RK	15-L3-2RK
					L	●	15-L3-8LK	15-L3-2LK
1 st Bicuspid	-17°	0°	4°	3.0 mm	R	●	15-L4-8R	15-L4-2R
					L	●	15-L4-8L	15-L4-2L
1 st Bicuspid Hk	-17°	0°	4°	3.0 mm	R	●	15-L4-8RK	15-L4-2RK
					L	●	15-L4-8LK	15-L4-2LK
2 nd Bicuspid	-22°	0°	4°	3.0 mm	R	●	15-L5-8R	15-L5-2R
					L	●	15-L5-8L	15-L5-2L
2 nd Bicuspid Hk	-22°	0°	4°	3.0 mm	R	●	15-L5-8RK	15-L5-2RK
					L	●	15-L5-8LK	15-L5-2LK

Bracket Kits Roth[®] Rx

Anchor-Lock Base

20 brackets per kit	.018	.022
Upper/Lower 5x5 Hook on 3	15K-3-18-01	15K-3-22-01
Upper/Lower 5x5 Hook on 3, 4, & 5	15K-345-18-01	15K-345-22-01

Brackets are packaged with 1 case oriented in a kit box.
 Brackets are also available as kits in bags.
 Brackets are also available in kits of 5 or 10 cases oriented in a carousel dispenser.



Agility® Bracket kit, 20 brackets oriented in a kit box



Bracket kits are also available in kits of 5 or 10 cases in a carousel dispenser.

**MBT is a trademark of 3M Unitek Corporation.

°G&H® prescriptions are not implied to be an exact version of any other system, nor do we claim any endorsement by the doctor.

Agility® Self-Ligating Brackets Precision Manufactured By G&H® Orthodontics

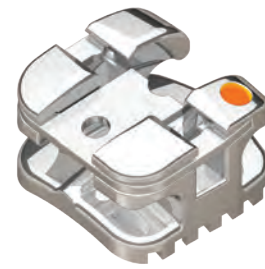

Individual brackets by tooth

Maxillary MBT** Rx

Anchor-Lock Base

Tooth	Torque	Angle	Rotation	M/D	R/L	ID	.018	.022
Central	17°	4°	0°	3.9 mm	R L	● ●	14-U1-8R 14-U1-8L	14-U1-2R 14-U1-2L
Lateral	10°	8°	0°	3.3 mm	R L	○ ○	14-U2-8R 14-U2-8L	14-U2-2R 14-U2-2L
Cuspid (without Hook)	-7°	8°	0°	3.3 mm	R L	● ●	14-U3-8R 14-U3-8L	14-U3-2R 14-U3-2L
Cuspid Hk (with Hook)	-7°	8°	0°	3.3 mm	R L	● ●	14-U3-8RK 14-U3-8LK	14-U3-2RK 14-U3-2LK
Cuspid	0°	8°	0°	3.3 mm	R L	● ●	N/A 14-U3-8L0	14-U3-2R0 14-U3-2L0
Cuspid Hk	0°	8°	0°	3.3 mm	R L	● ●	14-U3-8RK0 14-U3-8LK0	14-U3-2RK0 14-U3-2LK0
1 st & 2 nd Bicuspid	-7°	0°	0°	3.5 mm	U	●●	14-U4-8U	14-U4-2U
1 st & 2 nd Bicuspid Hk	-7°	0°	0°	3.5 mm	R L	● ●	14-U4-8RK 14-U4-8LK	14-U4-2RK 14-U4-2LK

Mandibular MBT** Rx

Anchor-Lock Base

Tooth	Torque	Angle	Rotation	M/D	R/L	ID	.018	.022
Anterior	-6°	0°	0°	2.6 mm	U	●●	14-L1-8U	14-L1-2U
Cuspid (without Hook)	-6°	3°	0°	3.5 mm	R L	● ●	14-L3-8R 14-L3-8L	14-L3-2R 14-L3-2L
Cuspid Hk (with Hook)	-6°	3°	0°	3.5 mm	R L	● ●	14-L3-8RK 14-L3-8LK	14-L3-2RK 14-L3-2LK
Cuspid (without Hook)	0°	3°	0°	3.5 mm	R L	● ●	N/A N/A	14-L3-2R0 14-L3-2L0
Cuspid Hk (with Hook)	0°	3°	0°	3.5 mm	R L	● ●	14-L3-8RK0 14-L3-8LK0	14-L3-2RK0 14-L3-2LK0
1 st Bicuspid	-12°	0°	0°	3.5 mm	U	●●	14-L4-8U	14-L4-2U
1 st Bicuspid Hk	-12°	0°	0°	3.5 mm	R L	● ●	14-L4-8RK 14-L4-8LK	14-L4-2RK 14-L4-2LK
2 nd Bicuspid	-17°	0°	0°	3.5 mm	U	●●	14-L5-8U	14-L5-2U
2 nd Bicuspid Hk	-17°	0°	0°	3.5 mm	R L	● ●	14-L5-8RK 14-L5-8LK	14-L5-2RK 14-L5-2LK

Bracket Kits MBT** Rx

Anchor-Lock Base

20 brackets per kit	.018	.022
Upper/Lower 5x5 Hook on 3	14K-3-18-01	14K-3-22-01
Upper/Lower 5x5 Hook on 3, 4, & 5	14K-345-18-01	14K-345-22-01

MBT Rx kits include 0° torque on the cuspids - custom kits available upon request.
 Brackets are packaged with 1 case oriented in a kit box.
 Brackets are also available as kits in bags.
 Brackets are also available in kits of 5 or 10 cases oriented in a carousel dispenser.



Agility® Bracket kit, 20 brackets oriented in a kit box



Bracket kits are also available in kits of 5 or 10 cases in a carousel dispenser.

**MBT is a trademark of 3M Unitek Corporation.

°G&H® prescriptions are not implied to be an exact version of any other system, nor do we claim any endorsement by the doctor.

G&H Precision Manufactured

Aesthetic Bracket Systems



Learn More

View our Vapor™ ceramic bracket video, debonding video, and patient cases.

Visit GHOrthodontics.com/Vapor





"I love how you can hardly tell I'm wearing braces! I feel more confident to smile."

Heather, actual patient, wearing G&H quality U.S. manufactured Vapor™ system.

AESTHETIC SYSTEMS MANUFACTURED BY G&H® IN THE U.S.A.

ARCHWIRES

TOOTH-COLORED G4™ NITI AND S3™ STAINLESS STEEL ARCHWIRES



As the world's best manufacturer of premium archwires, we use a proprietary epoxy coating which is durable, stain resistant, and just the right shade.



Nickel titanium tooth-colored archwires, page 50 – stainless steel tooth-colored archwires pages 56 & 67

BRACKETS

CERAMIC INJECTION MOLDED VAPOR™ BRACKETS



Our polycrystalline ceramic injection molded brackets are nearly invisible with a revolutionary bonding base for a secure bond and routine easy debonding.

Vapor™ Ceramic Brackets, page 23

ELASTOMERICS

BAMBINO™ TIES, ELASTOMERIC LIGATURE TIES

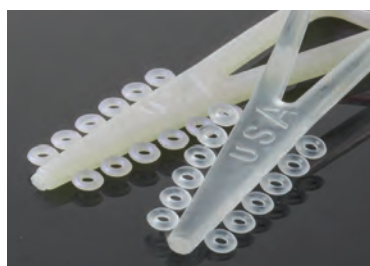

Our Bambino™ ties offer a softer feel for positive engagement and allow retention to any size bracket. Available in 33 colors including clear and pearl shown.

Bambino™ Ties, page 91

DYNA-LINK™ ELASTOMERIC CHAIN



Our Dyna-Link™ chain provides gentle, predictable tooth movement with superior memory and rebound. Available in 3 spacing variations and in 33 colors including clear and pearl shown.

Dyna-Link™ Chain, page 94

TOP SELLER!

VAPOR™ CERAMIC BRACKET SYSTEM

Patent Pending

Ceramic injection molded – CIM manufacturing

Full Feature mini twin design

Precision manufactured by G&H Orthodontics in the U.S.A.

A NEARLY INVISIBLE POLYCRYSTALLINE CERAMIC BRACKET

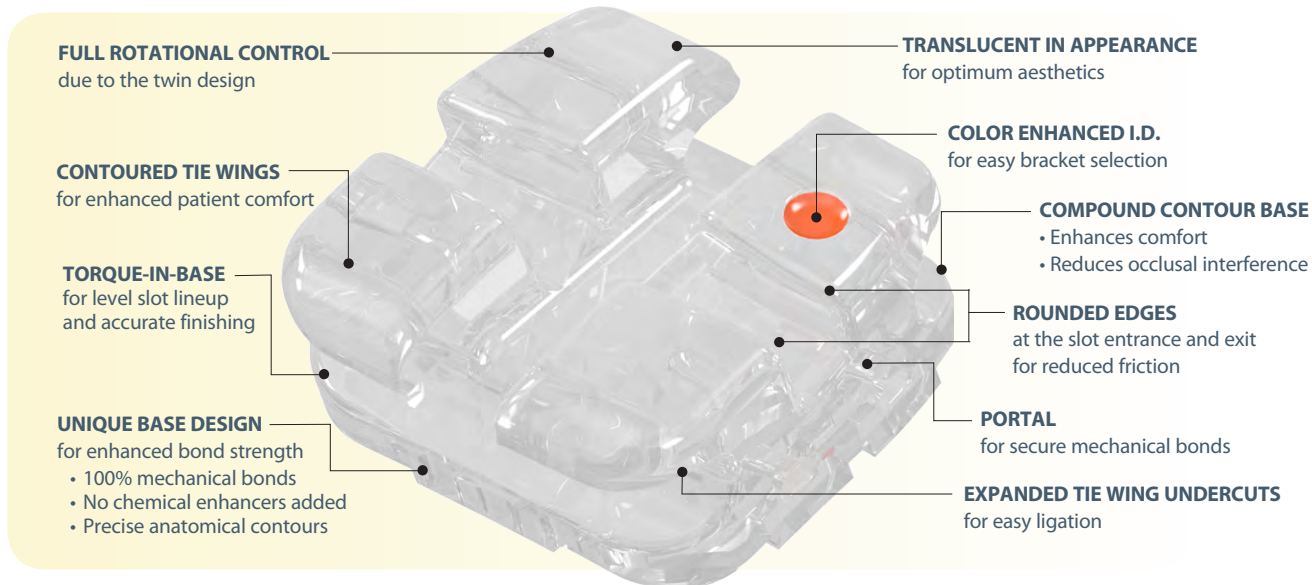

Hooks available on 3's, 4's and 5's



"The Vapor system provides all the characteristics one would look for in a high quality ceramic bracket: esthetics, ease of bonding, smoothness and strength. Thanks to the unique portals in the base, mechanical bond strength is enhanced yet the bracket is easy to debond. It is made in the USA and is cost-effective. I can't think of anything else one could possibly ask for!"

– Howard Fine, D.M.D., M.M.S.c

Vapor's Revolutionary "Portal" Bonding Base**

Only G&H® offers "Portal Base" Bonding Technology

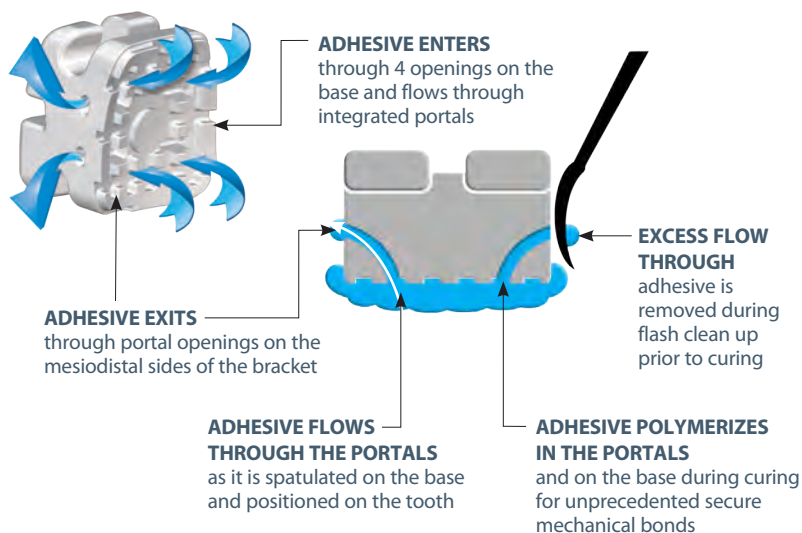

**100% mechanical bonds – No chemical bond enhancers added – No special or specific adhesive necessary



Learn More -
View our Vapor™ product video, debonding video, and patient cases - GHOrthodontics.com/Vapor

Easy and safe debonding with the same routine procedures used with metal brackets.

Brackets

Ceramic Brackets

Vapor™ Ceramic Brackets Precision Manufactured By G&H® Orthodontics



[Learn More -](#)
View our Vapor™ product video, debonding video, and patient cases - GHOrthodontics.com/Vapor

Vapor™ Bracket Kits

20 brackets per kit – upper & lower 5-5 .018 .022

Roth™ Rx

Upper/Lower 5x5 Hook on 3	75K-3-18-01	75K-3-22-01
Upper/Lower 5x5 Hook on 3, 4, & 5	75K-345-18-01	75K-345-22-01

MBT™ Rx

Upper/Lower 5x5 Hook on 3	76K-3-18-01	76K-3-22-01
Upper/Lower 5x5 Hook on 3, 4, & 5	76K-345-18-01	76K-345-22-01

MBT Rx kits include 0° torque on the cuspid - custom kits available upon request.
Brackets are packaged with 1 case oriented in a kit box.
Brackets are also available in kits of 5 or 10 cases oriented in a carousel dispenser.



Vapor™ Bracket kit, 20 brackets oriented in a kit box



Bracket kits are also available in kits of 5 or 10 cases in a carousel dispenser.

Vapor™ Bracket Identification

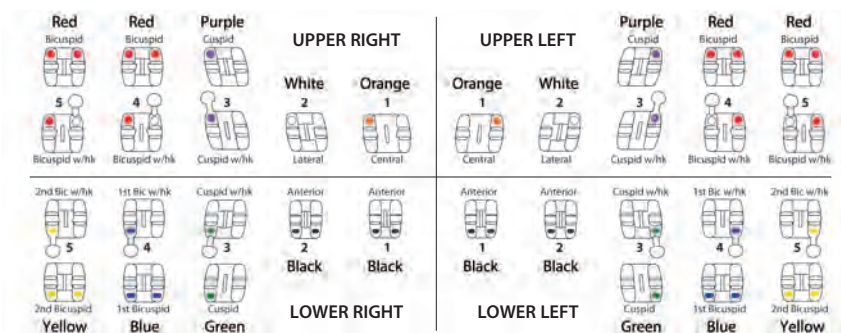

**MBT is a trademark of 3M Unitek Corporation.

°G&H® prescriptions are not implied to be an exact version of any other system, nor do we claim any endorsement by the doctor.

TOP SELLER!

Vapor™ Ceramic Brackets Precision Manufactured By G&H® Orthodontics



Individual brackets by tooth – Sold in packages of 5

Maxillary Roth[°] Rx

Tooth	Torque	Angle	Rotation	M/D	Slot Prof.	R/L	ID	.018	.022
Central	12°	5°	0°	.150"	.044"	R	●	75-U1-8R-V	75-U1-2R-V
						L	●	75-U1-8L-V	75-U1-2L-V
Lateral	8°	9°	0°	.132"	.051"	R	○	75-U2-8R-V	75-U2-2R-V
						L	○	75-U2-8L-V	75-U2-2L-V
Cuspid Hk	0°	11°	0°	.135"	.037"	R	●	75-U3-8RK-V	75-U3-2RK-V
						L	●	75-U3-8LK-V	75-U3-2LK-V
1 st & 2 nd Bicuspid	-7°	0°	0°	.130"	.042"	U	●●	75-U4-8U-V	75-U4-2U-V
1 st & 2 nd Bicuspid Hk	-7°	0°	0°	.130"	.042"	R	●	75-U4-8RK-V	75-U4-2RK-V
						L	●	75-U4-8LK-V	75-U4-2LK-V

Mandibular Roth[°] Rx

Tooth	Torque	Angle	Rotation	M/D	Slot Prof.	R/L	ID	.018	.022
Anterior	0°	0°	0°	.120"	.052"	U	●●	75-L1-8U-V	75-L1-2U-V
Cuspid Hk	-11°	5°	0°	.135"	.043"	R	●	75-L3-8RK-V	75-L3-2RK-V
						L	●	75-L3-8LK-V	75-L3-2LK-V
1 st Bicuspid	-17°	0°	0°	.130"	.043"	U	●●	75-L4-8U-V	75-L4-2U-V
1 st Bicuspid Hk	-17°	0°	0°	.130"	.043"	R	●	75-L4-8RK-V	75-L4-2RK-V
						L	●	75-L4-8LK-V	75-L4-2LK-V
2 nd Bicuspid	-22°	0°	0°	.130"	.043"	U	●●	75-L5-8U-V	75-L5-2U-V
2 nd Bicuspid Hk	-22°	0°	0°	.130"	.043"	R	●	75-L5-8RK-V	75-L5-2RK-V
						L	●	75-L5-8LK-V	75-L5-2LK-V

Bracket Kits Roth[°] Rx

20 brackets per kit	.018	.022
Upper/Lower 5x5 Hook on 3	75K-3-18-01	75K-3-22-01
Upper/Lower 5x5 Hook on 3, 4, & 5	75K-345-18-01	75K-345-22-01

Brackets are packaged with 1 case oriented in a kit box.

Brackets are also available in kits of 5 or 10 cases oriented in a carousel dispenser.



Vapor™ Bracket kit, 20 brackets oriented in a kit box



Bracket kits are also available in kits of 5 or 10 cases in a carousel dispenser.



Learn More -
View our Vapor™ product video, debonding video, and patient cases - GHOrthodontics.com/Vapor

Additional product considerations

Deluxe Bracket Holder

This reverse action stainless steel tweezer holds brackets and buccal tubes with thin, angled tips which are designed to slip under bracket and tube tie wings. It is ideal for miniature attachments.

Autoclavable up to 370°F/188°C

Ea. **ISP-057**

See our complete line of instruments starting on page 119



**MBT is a trademark of 3M Unitek Corporation.

°G&H® prescriptions are not implied to be an exact version of any other system, nor do we claim any endorsement by the doctor.



Individual brackets by tooth – Sold in packages of 5

Maxillary **MBT™ Rx**

Tooth	Torque	Angle	Rotation	M/D	Slot Prof.	R/L	ID	.018	.022
Central	17°	4°	0°	.150"	.044"	R	●	76-U1-8R-V	76-U1-2R-V
						L	●	76-U1-8L-V	76-U1-2L-V
Lateral	10°	8°	0°	.132"	.051"	R	○	76-U2-8R-V	76-U2-2R-V
						L	○	76-U2-8L-V	76-U2-2L-V
Cuspid Hk	-7°	8°	0°	.135"	.036"	R	●	76-U3-8RK-V	76-U3-2RK-V
						L	●	76-U3-8LK-V	76-U3-2LK-V
Cuspid Hk	0°	8°	0°	.135"	.036"	R	●	76-U3-8RK0-V	76-U3-2RK0-V
						L	●	76-U3-8LK0-V	76-U3-2LK0-V
1 st & 2 nd Bicuspid	-7°	0°	0°	.130"	.042"	U	●●	76-U4-8U-V	76-U4-2U-V
1 st & 2 nd Bicuspid Hk	-7°	0°	0°	.130"	.042"	R	●	76-U4-8RK-V	76-U4-2RK-V
						L	●	76-U4-8LK-V	76-U4-2LK-V

Mandibular **MBT™ Rx**

Tooth	Torque	Angle	Rotation	M/D	Slot Prof.	R/L	ID	.018	.022
Anterior	-6°	0°	0°	.120"	.052"	U	●●	76-L1-8U-V	76-L1-2U-V
Cuspid Hk	-6°	3°	0°	.135"	.043"	R	●	76-L3-8RK-V	76-L3-2RK-V
						L	●	76-L3-8LK-V	76-L3-2LK-V
Cuspid Hk	0°	3°	0°	.135"	.043"	R	●	76-L3-8RK0-V	76-L3-2RK0-V
						L	●	76-L3-8LK0-V	76-L3-2LK0-V
1 st Bicuspid	-12°	0°	0°	.130"	.042"	U	●●	76-L4-8U-V	76-L4-2U-V
1 st Bicuspid Hk	-12°	0°	0°	.130"	.042"	R	●	76-L4-8RK-V	76-L4-2RK-V
						L	●	76-L4-8LK-V	76-L4-2LK-V
2 nd Bicuspid	-17°	0°	0°	.130"	.042"	U	●●	76-L5-8U-V	76-L5-2U-V
2 nd Bicuspid Hk	-17°	0°	0°	.130"	.042"	R	●	76-L5-8RK-V	76-L5-2RK-V
						L	●	76-L5-8LK-V	76-L5-2LK-V

Bracket Kits **MBT™ Rx**

20 brackets per kit	.018	.022
Upper/Lower 5x5 Hook on 3	76K-3-18-01	76K-3-22-01
Upper/Lower 5x5 Hook on 3, 4, & 5	76K-345-18-01	76K-345-22-01

MBT Rx kits include 0° torque on the cuspids - custom kits available upon request.
 Brackets are packaged with 1 case oriented in a kit box.
 Brackets are also available in kits of 5 or 10 cases oriented in a carousel dispenser.



Vapor™ Bracket kit, 20 brackets oriented in a kit box



Bracket kits are also available in kits of 5 or 10 cases in a carousel dispenser.

**MBT is a trademark of 3M Unitek Corporation.

°G&H® prescriptions are not implied to be an exact version of any other system, nor do we claim any endorsement by the doctor.

PRISM™

COMPOSITE BRACKET SYSTEM

Precision Manufactured By G&H® Orthodontics

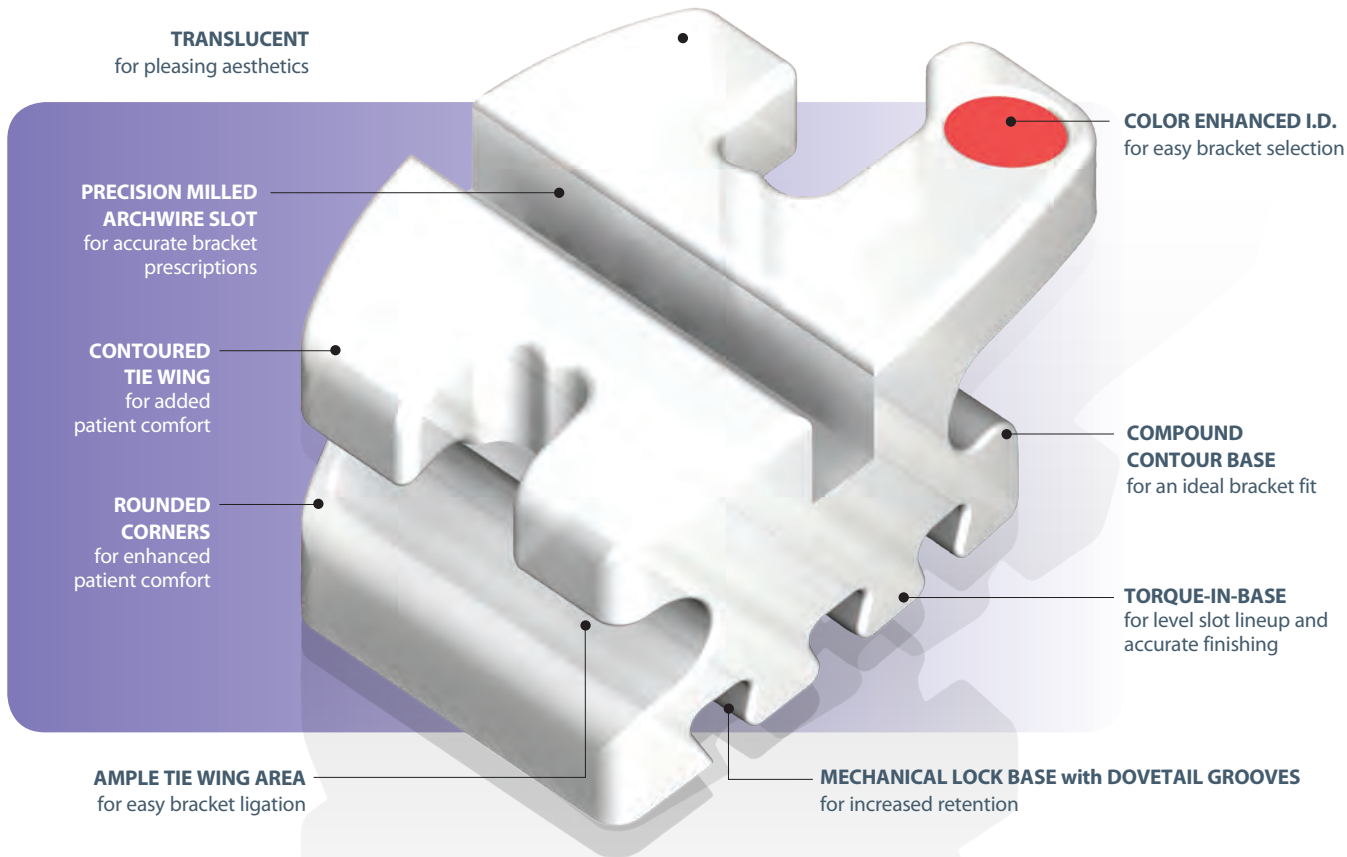

Prism™ Bracket Identification

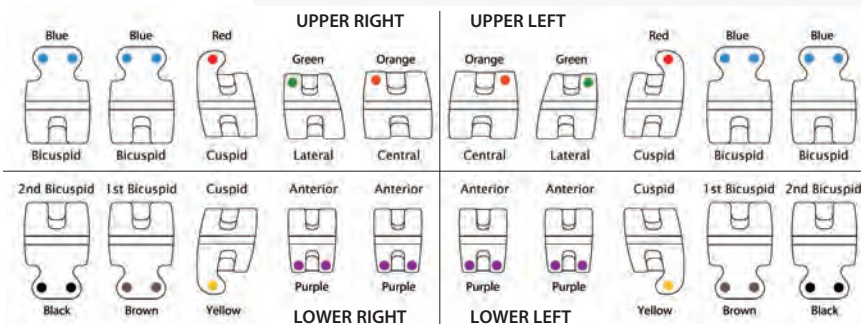

Prism™ aesthetic brackets applied to a demonstration model.

Prism™ Bracket Kits

20 brackets per kit – upper & lower 5-5

Roth™ Rx	.018	.022
Upper/Lower 5x5 Hook on 3	45K-3-18-01	45K-3-22-01
Upper/Lower 5x5 Hook on 3, 4, & 5	45K-345-18-01	45K-345-22-01
Edgewise Rx	.018	.022
Upper/Lower 5x5 No Hooks	47K-EDGE-18-01	47K-EDGE-22-01
MBT™ Rx	.018	.022
Upper/Lower 5x5 Hook on 3	46K-3-18-01	46K-3-22-01
Upper/Lower 5x5 Hook on 3, 4, & 5	46K-345-18-01	46K-345-22-01



Prism™ Bracket kit, 20 brackets oriented in a kit box



Bracket kits are also available in kits of 5 or 10 cases in a carousel dispenser.

**MBT is a trademark of 3M Unitek Corporation.

**G&H® prescriptions are not implied to be an exact version of any other system, nor do we claim any endorsement by the doctor.

Prism™ Composite Brackets Precision Manufactured By G&H® Orthodontics

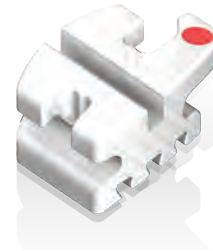

Individual brackets by tooth – Sold in packages of 5

Maxillary Roth° Rx

Tooth	Torque	Angle	Rotation	M/D	R/L	ID	.018	.022
Central	12°	5°	0°	3.9 mm	R	●	45-U1-8R-V	45-U1-2R-V
					L	●	45-U1-8L-V	45-U1-2L-V
Lateral	8°	9°	0°	3.3 mm	R	●	45-U2-8R-V	45-U2-2R-V
					L	●	45-U2-8L-V	45-U2-2L-V
Cuspid (without Hook)	0°	11°	4°	3.3 mm	R	●	45-U3-8R-V	45-U3-2R-V
					L	●	45-U3-8L-V	45-U3-2L-V
Cuspid Hk (with Hook)	0°	11°	4°	3.3 mm	R	●	45-U3-8RK-V	45-U3-2RK-V
					L	●	45-U3-8LK-V	45-U3-2LK-V
1 st & 2 nd Bicuspid	-7°	0°	0°	3.3 mm	U	●●	45-U4-8U-V	45-U4-2U-V
1 st & 2 nd Bicuspid Hk	-7°	0°	0°	3.3 mm	U	●●	45-U4-8UK-V	45-U4-2UK-V

Mandibular Roth° Rx

Tooth	Torque	Angle	Rotation	M/D	R/L	ID	.018	.022
Anterior	0°	0°	0°	2.8 mm	U	●●	45-L1-8U-V	45-L1-2U-V
Cuspid (without Hook)	-11°	5°	2°	3.3 mm	R	●	45-L3-8R-V	45-L3-2R-V
					L	●	N/A	45-L3-2L-V
Cuspid Hk (with Hook)	-11°	5°	2°	3.3 mm	R	●	45-L3-8RK-V	45-L3-2RK-V
					L	●	45-L3-8LK-V	45-L3-2LK-V
1 st Bicuspid	-17°	0°	0°	3.3 mm	U	●●	45-L4-8U-V	45-L4-2U-V
1 st Bicuspid Hk	-17°	0°	0°	3.3 mm	U	●●	45-L4-8UK-V	45-L4-2UK-V
2 nd Bicuspid	-22°	0°	0°	3.3 mm	U	●●	45-L5-8U-V	45-L5-2U-V
2 nd Bicuspid Hk	-22°	0°	0°	3.3 mm	U	●●	45-L5-8UK-V	45-L5-2UK-V

Bracket Kits Roth° Rx

20 brackets per kit	.018	.022
Upper/Lower 5x5 Hook on 3	45K-3-18-01	45K-3-22-01
Upper/Lower 5x5 Hook on 3, 4, & 5	45K-345-18-01	45K-345-22-01

Maxillary & Mandibular Edgewise Rx

Tooth	Torque	Angle	Rotation	M/D	R/L	ID	.018	.022
Central	0°	0°	0°	3.9 mm	U	--	47-CENT-18-V	47-CENT-22-V
Lateral	0°	0°	0°	3.3 mm	U	--	47-LAT-18-V	47-LAT-22-V
Cuspid	0°	0°	0°	3.3 mm	U	--	47-CUSP-18-V	47-CUSP-22-V
Bicuspid	0°	0°	0°	3.3 mm	U	--	47-BIC-18-V	47-BIC-22-V
Lower Anterior	0°	0°	0°	2.8 mm	U	--	47-ANT-18-V	47-ANT-22-V

Bracket Kits Edgewise Rx

20 brackets per kit	.018	.022
Upper/Lower 5x5 No Hooks	47K-EDGE-18-01	47K-EDGE-22-01

Brackets are packaged with 1 case oriented in a kit box.

Brackets are also available in kits of 5 or 10 cases oriented in a carousel dispenser.

**MBT is a trademark of 3M Unitek Corporation.

°G&H® prescriptions are not implied to be an exact version of any other system, nor do we claim any endorsement by the doctor.

Prism™ Composite Brackets Precision Manufactured By G&H® Orthodontics

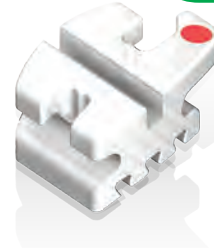

Individual brackets by tooth – Sold in packages of 5

Maxillary MBT** Rx

Tooth	Torque	Angle	Rotation	M/D	R/L	ID	.018	.022
Central	17°	4°	0°	3.9 mm	R L	● ●	46-U1-8R-V 46-U1-8L-V	46-U1-2R-V 46-U1-2L-V
Lateral	10°	8°	0°	3.3 mm	R L	● ●	46-U2-8R-V 46-U2-8L-V	46-U2-2R-V 46-U2-2L-V
Cuspid (without Hook)	-7°	8°	0°	3.3 mm	R L	● ●	N/A N/A	46-U3-2R-V 46-U3-2L-V
Cuspid Hk (with Hook)	0°	8°	0°	3.3 mm	R L	● ●	46-U3-8RK-V 46-U3-8LK-V	46-U3-2RK-V 46-U3-2LK-V
1 st & 2 nd Bicuspid	-7°	0°	0°	3.3 mm	U	●●	N/A	46-U4-2U-V
1 st & 2 nd Bicuspid Hk	-7°	0°	0°	3.3 mm	U	●●	N/A	46-U4-2UK-V

Mandibular MBT** Rx

Tooth	Torque	Angle	Rotation	M/D	R/L	ID	.018	.022
Anterior	-6°	0°	0°	2.8 mm	U	●●	46-L1-8U-V	46-L1-2U-V
Cuspid (without Hook)	-6°	3°	0°	3.3 mm	R L	● ●	N/A N/A	46-L3-2R-V 46-L3-2L-V
Cuspid Hk (with Hook)	0°	3°	0°	3.3 mm	R L	● ●	46-L3-8RK-V N/A	46-L3-2RK-V 46-L3-2LK-V
1 st Bicuspid	-12°	2°	0°	3.3 mm	R L	● ●	46-L4-8R-V 46-L4-8L-V	46-L4-2R-V 46-L4-2L-V
1 st Bicuspid Hk	-12°	2°	0°	3.3 mm	R L	● ●	N/A 46-L4-8LK-V	46-L4-2RK-V 46-L4-2LK-V
2 nd Bicuspid	-17°	2°	0°	3.3 mm	R L	● ●	46-L5-8R-V 46-L5-8L-V	46-L5-2R-V 46-L5-2L-V
2 nd Bicuspid Hk	-17°	2°	0°	3.3 mm	R L	● ●	46-L5-8RK-V 46-L5-8LK-V	46-L5-2RK-V 46-L5-2LK-V

Bracket Kits MBT** Rx

20 brackets per kit	.018	.022
Upper/Lower 5x5 Hook on 3	46K-3-18-01	46K-3-22-01
Upper/Lower 5x5 Hook on 3, 4, & 5	46K-345-18-01	46K-345-22-01



MBT Rx kits include 0° torque on the cuspids - custom kits available upon request.
Brackets are packaged with 1 case oriented in a kit box.
Brackets are also available in kits of 5 or 10 cases oriented in a carousel dispenser.



Prism™ Bracket kit, 20 brackets oriented in a kit box



Bracket kits are also available in kits of 5 or 10 cases in a carousel dispenser.

**MBT is a trademark of 3M Unitek Corporation.

**G&H® prescriptions are not implied to be an exact version of any other system, nor do we claim any endorsement by the doctor.

INTRODUCING -

NEW!

miniPrevail® TUBE

Precision Manufactured By G&H® Orthodontics

Seamlessly working together with our miniPrevail® bracket systems

Our new miniPrevail®TUBE has been engineered with the patient and orthodontist in mind. Our distinct "crosshair" design takes the guesswork out of placement while the tube features offer easy wire placement and engagement. Finally, the low profile and sleek hook is designed for the utmost patient comfort.

LOW PROFILE
metal injection molded (MIM)
stainless steel

BALANCED
to facilitate easier bonding

SLEEK HOOK DESIGN
for ultimate patient comfort
and simplified bonding

FUNNELED ENTRANCE
for easier wire insertion

**MICRO-ETCHED
80 GAUGE MESH BASE**
for enhanced bond strength

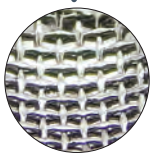

DISTINCT "CROSSHAIR"
horizontal and vertical placement
sight lines with **COLOR-CODED ID**
center "bullseye" positioning feature



**Available in 4.2mm or 3.2mm
MESIAL/DISTAL DIMENSION**
for full rotational control

ANGLED OCCLUSAL WALL
to avoid interference

PARALLEL WALLS
for improved grip when handling

**OCCLUSAL/GINGIVAL
PLACEMENT GUIDES**
allow for easy placement at
the posterior region and assist
with minor adjustments prior
to curing the adhesive

ANATOMICALLY FORMED BASE
with developmental indent for
precise fit and positioning

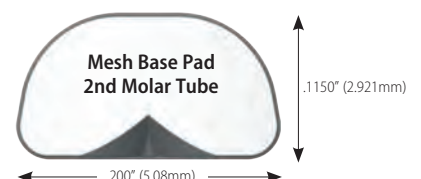
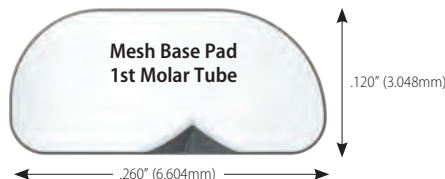

miniPrevail®TUBE – Single, Non-Convertible



Mesh base dimension of bondable 1st molar tubes,
.260" (6.604mm) x .120" (3.048mm)

Maxillary 1 st Molar						Weldable		Bondable	
Torque	Offset	Rx	M/D	R/L	ID	.018	.022	.018	.022
0°	0°	STD	4.2 mm	R	●	NS6-821-X	NS6-221-X	NS6B-821E-X	NS6B-221E-X
				L	●	NS6-822-X	NS6-222-X	NS6B-822E-X	NS6B-222E-X
-10°	8°	Roth™	4.2 mm	R	●	NS6-825-X	NS6-225-X	NS6B-825E-X	NS6B-225E-X
				L	●	NS6-826-X	NS6-226-X	NS6B-826E-X	NS6B-226E-X
-14°	10°	MBT™	4.2 mm	R	●	NS6-833-X	NS6-233-X	NS6B-833E-X	NS6B-233E-X
				L	●	NS6-834-X	NS6-234-X	NS6B-834E-X	NS6B-234E-X
-10°	0°	MBT™	4.2 mm	R	●	NS6-831-X	NS6-231-X	NS6B-831E-X	NS6B-231E-X
				L	●	NS6-832-X	NS6-232-X	NS6B-832E-X	NS6B-232E-X

Mandibular 1 st Molar						Weldable		Bondable	
Torque	Offset	Rx	M/D	R/L	ID	.018	.022	.018	.022
0°	0°	STD	4.2 mm	R	●	NS6-822-X	NS6-222-X	NS6B-822E-X	NS6B-222E-X
				L	●	NS6-821-X	NS6-221-X	NS6B-821E-X	NS6B-221E-X
-25°	5°	Roth™	4.2 mm	R	●	NS6-827-X	NS6-227-X	NS6B-827E-X	NS6B-227E-X
				L	●	NS6-828-X	NS6-228-X	NS6B-828E-X	NS6B-228E-X
-20°	0°	MBT™	4.2 mm	R	●	NS6-809-X	NS6-209-X	NS6B-809E-X	NS6B-209E-X
				L	●	NS6-810-X	NS6-210-X	NS6B-810E-X	NS6B-210E-X
-10°	0°	MBT™	4.2 mm	R	●	NS6-832-X	NS6-232-X	NS6B-832E-X	NS6B-232E-X
				L	●	NS6-831-X	NS6-231-X	NS6B-831E-X	NS6B-231E-X



Mesh base dimension of bondable 2nd molar tubes,
.200" (5.08mm) x .1150" (2.921mm)

Maxillary 2 nd Molar						Weldable		Bondable	
Torque	Offset	Rx	M/D	R/L	ID	.018	.022	.018	.022
0°	0°	STD	3.2 mm	R	●	NS7-821-X	NS7-221-X	NS7B-821I-X	NS7B-221I-X
				L	●	NS7-822-X	NS7-222-X	NS7B-822I-X	NS7B-222I-X
-10°	8°	Roth™	3.2 mm	R	●	NS7-825-X	NS7-225-X	NS7B-825I-X	NS7B-225I-X
				L	●	NS7-826-X	NS7-226-X	NS7B-826I-X	NS7B-226I-X
-14°	10°	MBT™	3.2 mm	R	●	NS7-833-X	NS7-233-X	NS7B-833I-X	NS7B-233I-X
				L	●	NS7-834-X	NS7-234-X	NS7B-834I-X	NS7B-234I-X
-10°	0°	MBT™	3.2 mm	R	●	NS7-831-X	NS7-231-X	NS7B-831I-X	NS7B-231I-X
				L	●	NS7-832-X	NS7-232-X	NS7B-832I-X	NS7B-232I-X

Mandibular 2 nd Molar						Weldable		Bondable	
Torque	Offset	Rx	M/D	R/L	ID	.018	.022	.018	.022
0°	0°	STD	3.2 mm	R	●	NS7-822-X	NS7-222-X	NS7B-822I-X	NS7B-222I-X
				L	●	NS7-821-X	NS7-221-X	NS7B-821I-X	NS7B-221I-X
-25°	5°	Roth™	3.2 mm	R	●	NS7-827-X	NS7-227-X	NS7B-827I-X	NS7B-227I-X
				L	●	NS7-828-X	NS7-228-X	NS7B-828I-X	NS7B-228I-X
-20°	0°	MBT™	3.2 mm	R	●	NS7-809-X	NS7-209-X	NS7B-809I-X	NS7B-209I-X
				L	●	NS7-810-X	NS7-210-X	NS7B-810I-X	NS7B-210I-X
-10°	0°	MBT™	3.2 mm	R	●	NS7-832-X	NS7-232-X	NS7B-832I-X	NS7B-232I-X
				L	●	NS7-831-X	NS7-231-X	NS7B-831I-X	NS7B-231I-X

Innovative technology and sleek, stylish comfort.

VIPER™ LOW PROFILE BUCCAL TUBES

VIPER™ Low Profile Buccal Tubes

Sleek and stylish, G&H's Viper™ buccal tube incorporates the latest design technology with a growing industry demand for comfortable, easy-to-use appliances that simplify treatment and reduce valuable chair time.

Precision Manufactured By G&H® Orthodontics

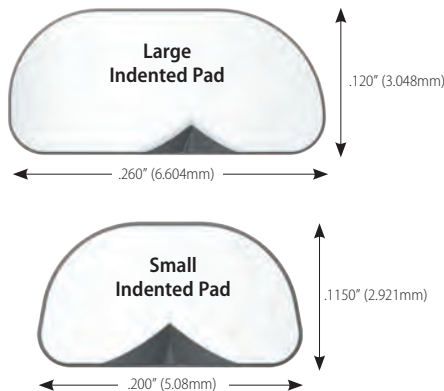
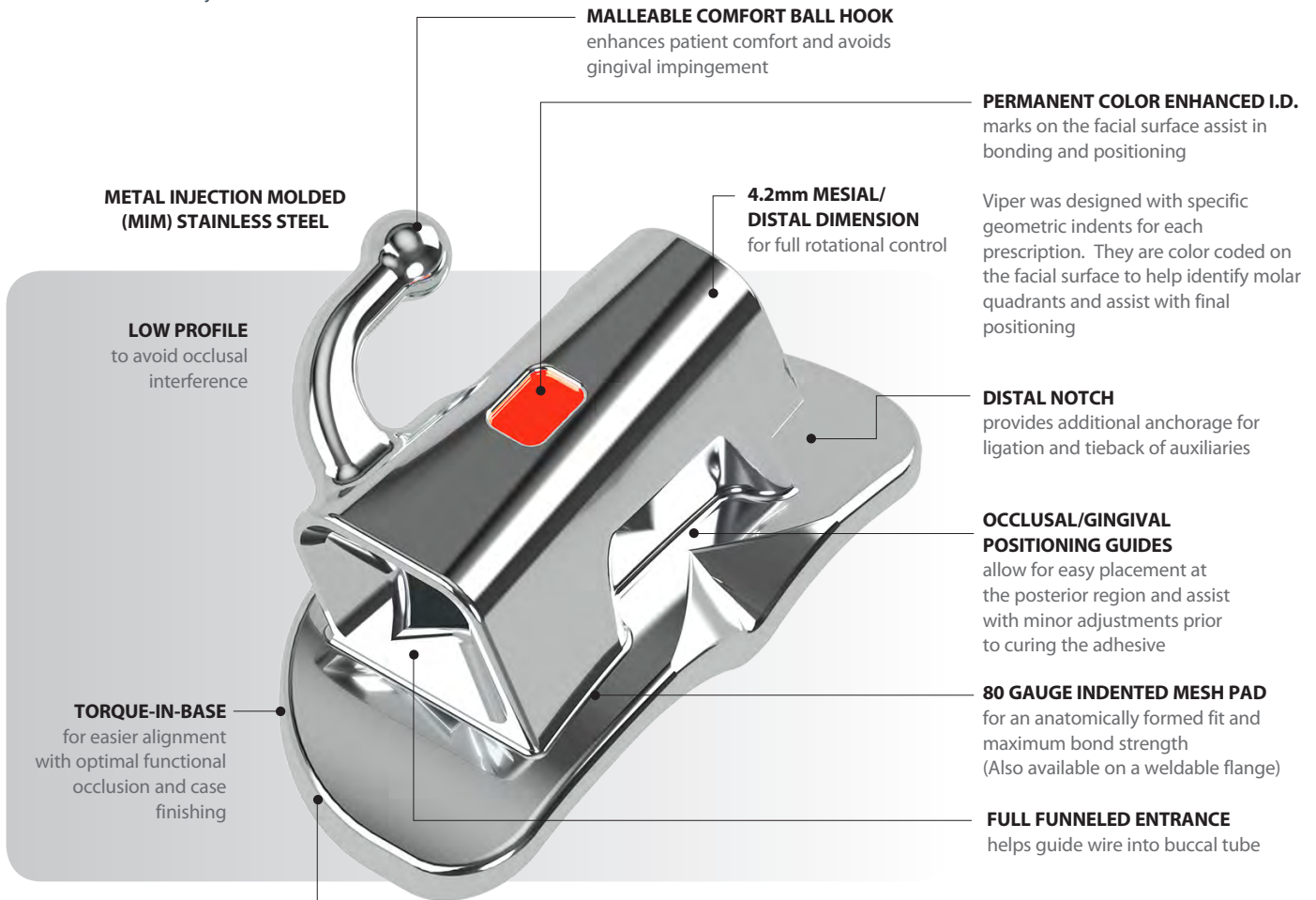

Confidence is in the Design

Achieving stronger, more consistent bonds in every case is made possible by unique pad designs that accommodate a wide array of treatment needs.

Developmental Indent

Because precise positioning is critical in establishing an effective treatment and avoiding occlusal interference with opposing teeth, we designed our bond pads with pronounced developmental indents to make locating the optimal bonding position a snap.

Unique Pad Design

A uniquely crafted distal gingival cutout enables the bonding of partially erupted molars without sacrificing the size and strength of the pad.

Molded Compound Contour Base

Anatomically conforms to the tooth and provides proper fit and appliance expression.

80 Gauge Mesh

Featuring an 80 gauge mesh base in three different pad configurations, our direct bond tubes are sure to meet all of your treatment needs.

Viper™ Buccal Tubes Precision Manufactured By G&H® Orthodontics

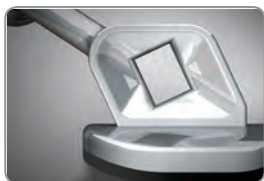

G&H® has eliminated the frustration and wasted time of threading a wire into the small opening of traditional buccal tubes. The Viper's trumpeted entrance facilitates easy wire insertion. Wires are guided easily and gently into Viper's expansive entrance, simplifying arch wire adjustments and saving valuable chair time.



Custom Welding

Viper™ buccal tubes are also available custom welded directly onto bands to meet your specific requirements and provide added convenience. With consistent quality products and custom applications that you can count on every time, G&H® is here to help your practice thrive.

No charge for custom welding on G&H bands. (Bands are on pages 35-39)

Single Non-Convertible

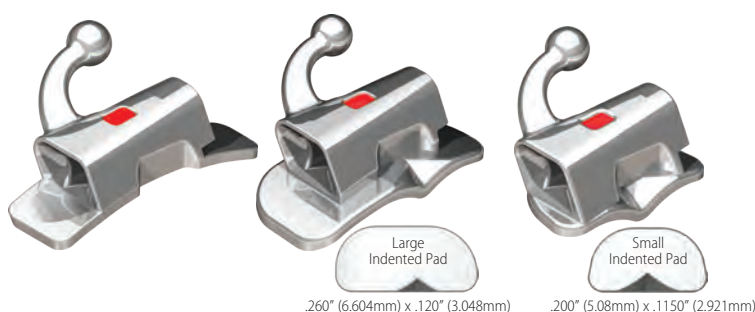

.260" (6.604mm) x .120" (3.048mm)

.200" (5.08mm) x .1150" (2.921mm)

Maxillary 1st & 2nd Molar

Torque	Offset	Rx	M/D	R/L	ID	Weldable		Bondable			
						.018	.022	.018	.022	.018	.022
0° (W/O Distal Extension)	0°	STD	4.2 mm	R	◆	NS3-821	NS3-221	NS3B-821E	NS3B-221E	NS3B-821I	NS3B-221I
				L	◆	NS3-822	NS3-222	NS3B-822E	NS3B-222E	NS3B-822I	NS3B-222I
-10° (W/Distal Extension)	8°	Roth ™	4.2 mm	R	●	NS3-825	NS3-225	NS3B-825E	NS3B-225E	NS3B-825I	NS3B-225I
				L	●	NS3-826	NS3-226	NS3B-826E	NS3B-226E	NS3B-826I	NS3B-226I
-14° (W/Distal Extension)	10°	MBT ™	4.2 mm	R	●	NS3-833	NS3-233	NS3B-833E	NS3B-233E	NS3B-833I	NS3B-233I
				L	●	NS3-834	NS3-234	NS3B-834E	NS3B-234E	NS3B-834I	NS3B-234I

Mandibular 1st & 2nd Molar

Torque	Offset	Rx	M/D	R/L	ID	Weldable		Bondable			
						.018	.022	.018	.022	.018	.022
0° (W/O Distal Extension)	0°	STD	4.2 mm	R	◆	NS3-822	NS3-222	NS3B-822E	NS3B-222E	NS3B-822I	NS3B-222I
				L	◆	NS3-821	NS3-221	NS3B-821E	NS3B-221E	NS3B-821I	NS3B-221I
-25° (W/Distal Extension)	5°	Roth ™	4.2 mm	R	■	NS3-827	NS3-227	NS3B-827E	NS3B-227E	NS3B-827I	NS3B-227I
				L	■	NS3-828	NS3-228	NS3B-828E	NS3B-228E	NS3B-828I	NS3B-228I
-20° (W/O Distal Extension)	0°	MBT ™	4.2 mm	R	▲	NS3-809	NS3-209	NS3B-809E	NS3B-209E	NS3B-809I	NS3B-209I
				L	▲	NS3-810	NS3-210	NS3B-810E	NS3B-210E	NS3B-810I	NS3B-210I

**MBT is a trademark of 3M Unitek Corporation.

°G&H® prescriptions are not implied to be an exact version of any other system, nor do we claim any endorsement by the doctor.

Viper™ Buccal Tubes Precision Manufactured By G&H® Orthodontics

Viper™ Low Profile Mini 2nd Tube

Specially designed for partially erupted 2nd Molars.

Viper™ Mini Low Profile Buccal Tubes incorporate all the great features of our standard Viper™ series, but in a small feature-rich design that allows for earlier bonding of partially erupted second molars. The Viper's trumpeted entrance facilitates easy wire insertion. Wires are guided easily and gently into Viper's expansive entrance, simplifying archwire adjustments and saving valuable chair time. Bonds with less effort by the clinician and less soft tissue trauma to the patient.



Specially designed for partially erupted 2nd Molars

- Single piece construction
- 2.5mm mesiodistal length

Maxillary & Mandibular 2nd Molar

Torque	Offset	M/D	R/L	ID	.018	.022
0°	0°	2.5 mm	UR/LL	◆	NS4B-821	NS4B-221
			UL/LR	◆	NS4B-822	NS4B-222
-10°	0°	2.5 mm	UR	●	NS4B-831	NS4B-231
			UL	●	NS4B-832	NS4B-232
-14°	0°	2.5 mm	UR/LL	●	NS4B-835	NS4B-235
			UL/LR	●	NS4B-836	NS4B-236
-25°	0°	2.5 mm	LR	■	NS4B-833	NS4B-233
			LL	■	NS4B-834	NS4B-234

**MBT is a trademark of 3M Unitek Corporation.

°G&H® prescriptions are not implied to be an exact version of any other system, nor do we claim any endorsement by the doctor.

VIPER™ CV LOW PROFILE BUCCAL TUBES

Precision Manufactured By G&H® Orthodontics

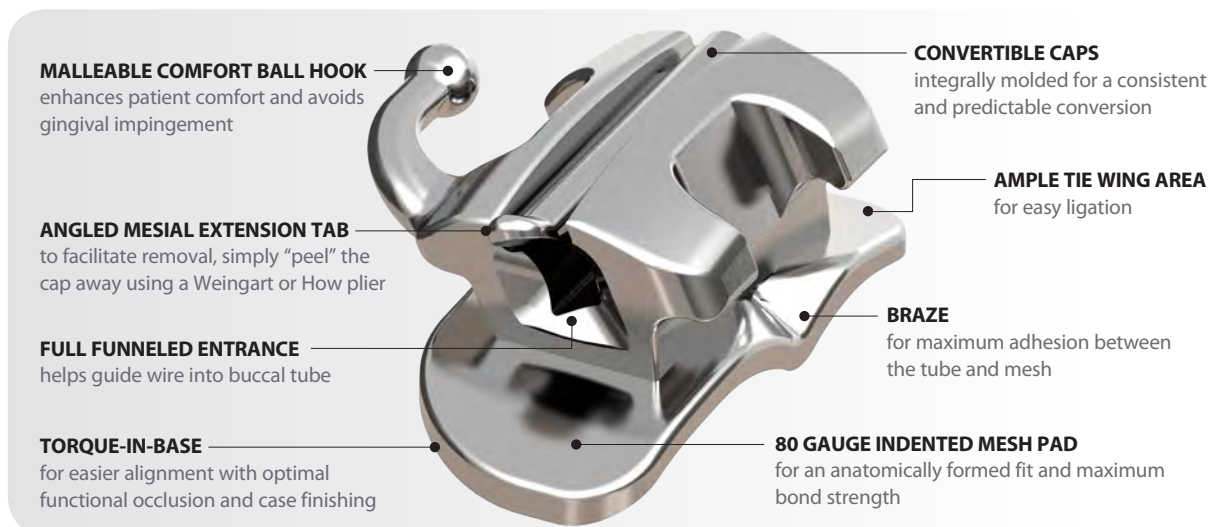

METAL INJECTION MOLDED (MIM) STAINLESS STEEL

Single Convertible



Maxillary 1 st Molar					Weldable		Bondable			
Torque	Offset	Rx	M/D	R/L	.018	.022	.018	.022	.018	.022
-10°	8°	Roth™	4.2 mm	R	CS3-805	CS3-205	CS3B-805E	CS3B-205E	CS3B-805I	CS3B-205I
				L	CS3-806	CS3-206	CS3B-806E	CS3B-206E	CS3B-806I	CS3B-206I
-14°	10°	MBT**	4.2 mm	R	CS3-813	CS3-213	CS3B-813E	CS3B-213E	CS3B-813I	CS3B-213I
				L	CS3-814	CS3-214	CS3B-814E	CS3B-214E	CS3B-814I	CS3B-214I

Mandibular 1 st Molar					Weldable		Bondable			
Torque	Offset	Rx	M/D	R/L	.018	.022	.018	.022	.018	.022
-25°	5°	Roth™	4.2 mm	R	CS3-807	CS3-207	CS3B-807E	CS3B-207E	CS3B-807I	CS3B-207I
				L	CS3-808	CS3-208	CS3B-808E	CS3B-208E	CS3B-808I	CS3B-208I
-20°	0°	MBT**	4.2 mm	R	CS3-815	CS3-215	CS3B-815E	CS3B-215E	CS3B-815I	CS3B-215I
				L	CS3-816	CS3-216	CS3B-816E	CS3B-216E	CS3B-816I	CS3B-216I

**MBT is a trademark of 3M Unitek Corporation.

°G&H® prescriptions are not implied to be an exact version of any other system, nor do we claim any endorsement by the doctor.

Viper™ Buccal Tubes Precision Manufactured By G&H® Orthodontics

VIPER™ CV

COMBINATION BUCCAL TUBES

Precision Manufactured By G&H® Orthodontics

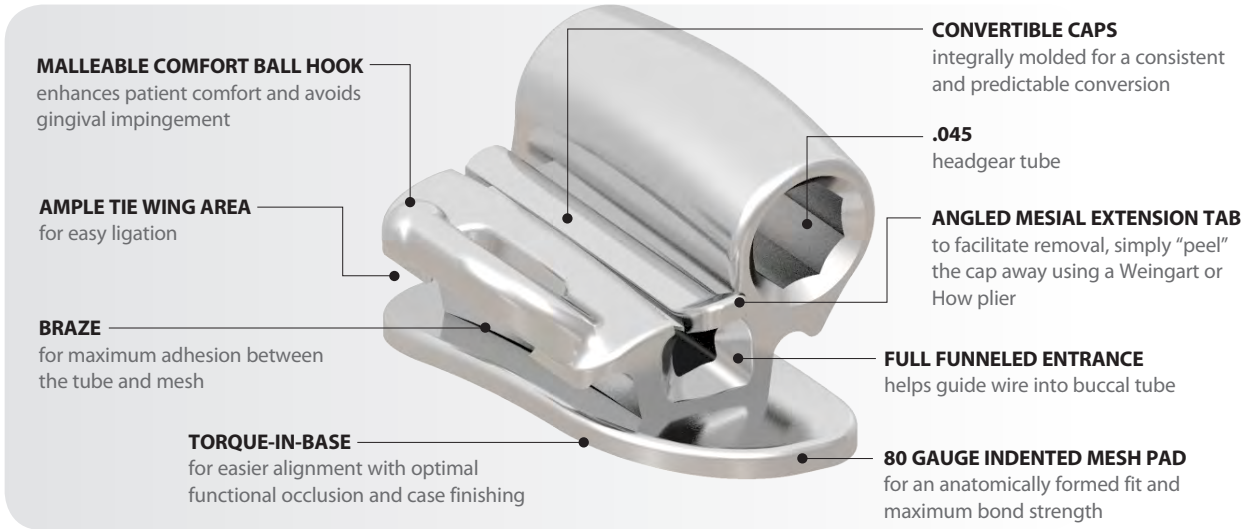

METAL INJECTION MOLDED
(MIM) STAINLESS STEEL

Combination Convertible



Maxillary 1st Molar

Torque	Offset	Rx	M/D	R/L	Weldable		Bondable	
					.018	.022	.018	.022
-10°	8°	Roth™	4.2 mm	R	CC3-805	CC3-205	CC3B-805E	CC3B-205E
				L	CC3-806	CC3-206	CC3B-806E	CC3B-206E
-14°	10°	MBT™	4.2 mm	R	CC3-817	CC3-217	CC3B-817E	CC3B-217E
				L	CC3-818	CC3-218	CC3B-818E	CC3B-218E

**MBT is a trademark of 3M Unitek Corporation.

°G&H® prescriptions are not implied to be an exact version of any other system, nor do we claim any endorsement by the doctor.

Magnum™ Buccal Tubes Precision Manufactured By G&H® Orthodontics

MAGNUM™ BUCCAL TUBES

Precision Manufactured By G&H® Orthodontics

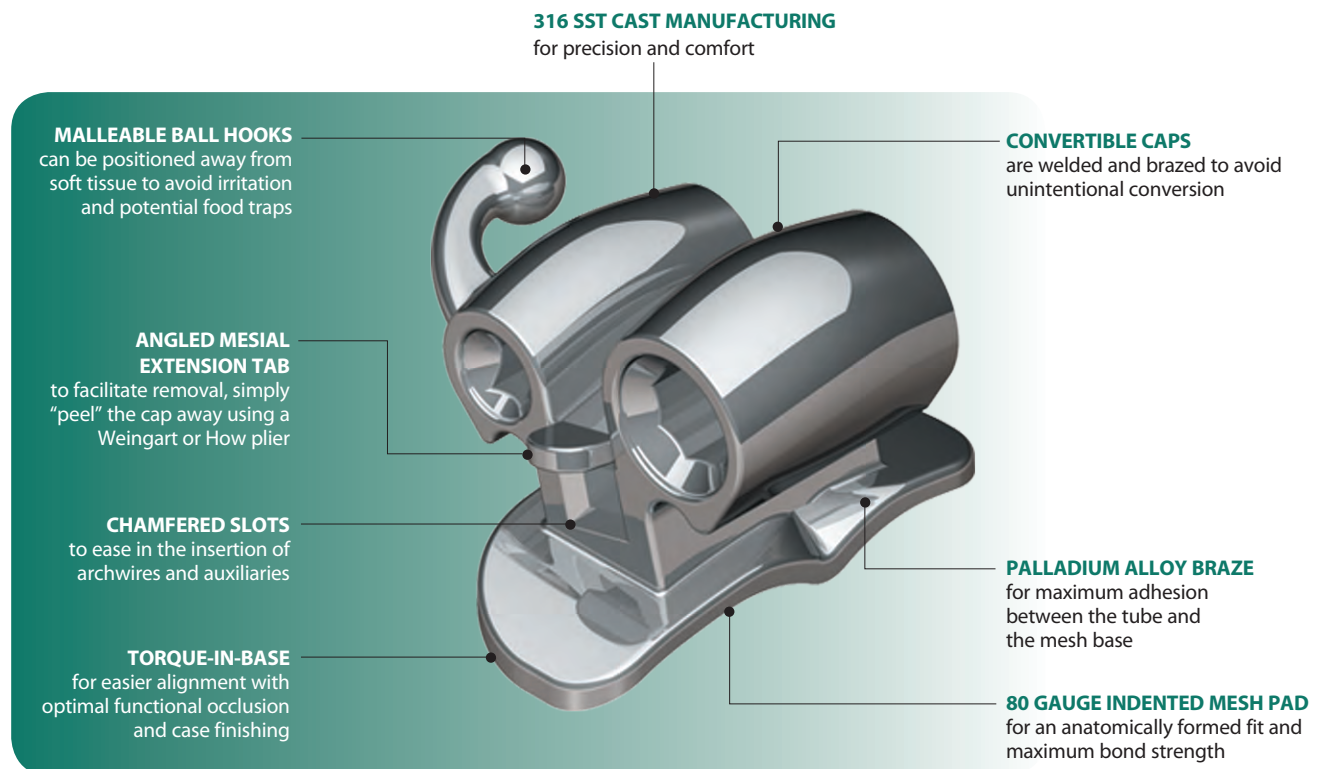

Available Three Ways: Bondable, Weldable or Pre-Welded

All buccal tubes offered by G&H® are available with direct bond bases, weldable for welding your own assemblies, or pre-welded directly on bands to meet your specific needs and to provide added convenience. With consistent quality products and custom applications that you can count on every time, G&H® is here to help your practice thrive.

G&H®'s Magnum™ Buccal Tube line offers miniaturized cast buccal tubes with rounded surfaces for exceptional patient comfort and acceptance.

Comfort is in the Design

G&H®'s advanced design and manufacturing technologies ensure the maximum strength of our small, precision tubes for increased clinical efficiency and patient comfort. Both occlusal interference and gingival impingement are reduced, and hygiene is improved. All convertible tubes incorporate a true "twin" bracket tie wing design to aid in ligation. Our combination tubes also incorporate a distinctive tie wing design for secure ligation following archwire slot conversion, and are offset from the gingival to avoid tissue impingement.

Magnum™ Convertible Tubes

Triple Convertible HG Occlusal



.260" (6.604mm) x .120" (3.048mm)

Maxillary 1st Molar

Torque	Offset	Rx	HG I.D.	Aux. Tube	M/D	R/L	Weldable		Bondable	
							.018	.022	.018	.022
-10°	8°	Roth [°]	.045" Occl.	.018 / 0°T	3.5 mm	R	CT1-805	CT1-205	CT1B-805E	CT1B-205E
						L	CT1-806	CT1-206	CT1B-806E	CT1B-206E
-10°	8°	Roth [°]	.051" Occl.	.018 / 0°T	3.5 mm	R	CT1-855	CT1-255	-	-
						L	CT1-856	CT1-256	-	-
-14°	10°	MBT ^{**}	.045" Occl.	.018 / 0°T	3.5 mm	R	CT1-807	CT1-207	CT1B-807E	CT1B-207E
						L	CT1-808	CT1-208	CT1B-808E	CT1B-208E
-14°	10°	MBT ^{**}	.051" Occl.	.018 / 0°T	3.5 mm	R	CT1-857	CT1-257	-	-
						L	CT1-858	CT1-258	-	-

Combination Convertible HG Gingival

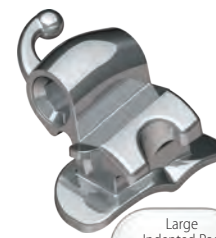

.260" (6.604mm) x .120" (3.048mm)

Maxillary 1st Molar

Torque	Offset	Rx	HG I.D.	Aux. Tube	M/D	R/L	Weldable		Bondable	
							.018	.022	.018	.022
-10°	8°	Roth [°]	.045" Ging.	-	3.5 mm	R	CC-815	CC-215	CCB-815E	CCB-215E
						L	CC-816	CC-216	CCB-816E	CCB-216E
-10°	8°	Roth [°]	.051" Ging.	-	3.5 mm	R	-	CC-255	-	-
						L	-	CC-256	-	-
-14°	10°	MBT ^{**}	.045" Ging.	-	3.5 mm	R	CC1-817	CC1-217	CC1B-817E	CC1B-217E
						L	CC1-818	CC1-218	CC1B-818E	CC1B-218E
-14°	10°	MBT ^{**}	.051" Ging.	-	3.5 mm	R	-	CC1-257	-	-
						L	-	CC1-258	-	-

Mandibular 1st Molar

Torque	Offset	Rx	HG I.D.	Aux. Tube	M/D	R/L	Weldable		Bondable	
							.018	.022	.018	.022
-25°	5°	Roth [°]	.045" Ging.	-	3.5 mm	R	CL1-807	CL1-207	CL1B-807E	CL1B-207E
						L	CL1-808	CL1-208	CL1B-808E	CL1B-208E

**MBT is a trademark of 3M Unitek Corporation.

°G&H® prescriptions are not implied to be an exact version of any other system, nor do we claim any endorsement by the doctor.

Magnum™ Convertible Tubes

Double Convertible

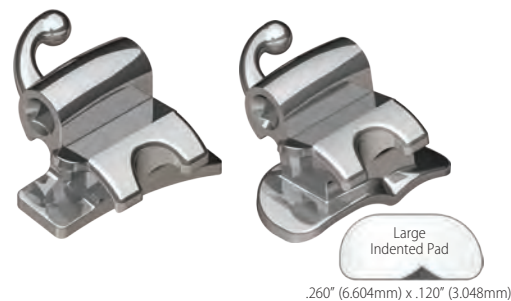

Maxillary 1st Molar

Torque	Offset	Rx	HG I.D.	Aux. Tube	M/D	R/L	Weldable		Bondable	
							.018	.022	.018	.022
-10°	8°	Roth™	-	.018 / 0°T	3.5 mm	R	CD1-805	CD1-205	CD1B-805E	CD1B-205E
						L	CD1-806	CD1-206	CD1B-806E	CD1B-206E

Mandibular 1st Molar

Torque	Offset	Rx	HG I.D.	Aux. Tube	M/D	R/L	Weldable		Bondable	
							.018	.022	.018	.022
-25°	5°	Roth™	-	.018 / 0°T	3.5 mm	R	CD1-807	CD1-207	CD1B-807E	CD1B-207E
						L	CD1-808	CD1-208	CD1B-808E	CD1B-208E
-20°	0°	MBT™	-	.018 / 0°T	3.5 mm	R	CD1-809	CD1-209	CD1B-809E	CD1B-209E
						L	CD1-810	CD1-210	CD1B-810E	CD1B-210E

Magnum™ Non-Convertible Tubes

Combination Non-Convertible HG Occlusal



Maxillary 1st Molar

Torque	Offset	Rx	HG I.D.	M/D	R/L	Weldable		Bondable	
						.018	.022	.018	.022
0°	0°	-	.045" Occl.	3.5 mm	R	NC1-821	NC1-221	NC1B-821E	NC1B-221E
					L	NC1-822	NC1-222	NC1B-822E	NC1B-222E
0°	0°	-	.051" Occl.	3.5 mm	R	NC1-851	-	-	-
					L	NC1-852	-	-	-
0°	8°	-	.045" Occl.	3.5 mm	R	NC1-823	NC1-223	-	-
					L	NC1-824	NC1-224	-	-
-10°	8°	Roth™	.045" Occl.	3.5 mm	R	NC1-825	NC1-225	NC1B-825E	NC1B-225E
					L	NC1-826	NC1-226	NC1B-826E	NC1B-226E
-10°	8°	Roth™	.051" Occl.	3.5 mm	R	NC1-855	NC1-255	-	-
					L	NC1-856	NC1-256	-	-
-14°	10°	MBT™	.045" Occl.	3.5 mm	R	NC1-827	NC1-227	NC1B-827E	NC1B-227E
					L	NC1-828	NC1-228	NC1B-828E	NC1B-228E
-14°	10°	MBT™	.051" Occl.	3.5 mm	R	NC1-857	NC1-257	-	-
					L	NC1-858	NC1-258	-	-

**MBT is a trademark of 3M Unitek Corporation.

°G&H® prescriptions are not implied to be an exact version of any other system, nor do we claim any endorsement by the doctor.

Magnum™ Non-Convertible Tubes

Ricketts* Triple Non-Convertible HG Occlusal

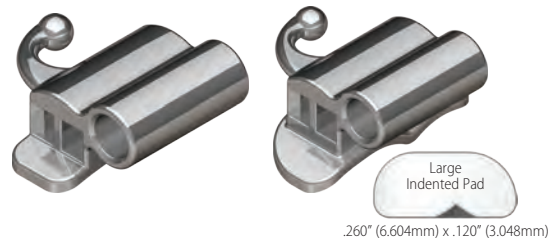

Maxillary 1st Molar

Torque	Offset	Rx	HG I.D.	M/D	R/L	Weldable		Bondable	
						.018	.022	.018	.022
0°	0°	--	.045" Occl.	3.5 mm	R	NRT1-821	–	NRT1B-821E	–
					L	NRT1-822	–	NRT1B-822E	–

Ricketts* Double Non-Convertible w/Aux. Hk

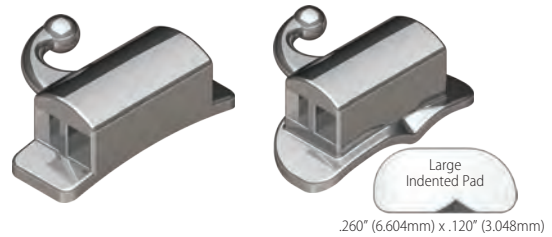

Maxillary 1st Molar

Torque	Offset	Rx	HG I.D.	M/D	R/L	Weldable		Bondable	
						.018	.022	.018	.022
0°	0°	--	--	3.5 mm	UL/LR	NRD1-821	–	NRD1B-821E	–
					UR/LL	NRD1-822	–	NRD1B-822E	–

Ricketts* Double Non-Convertible w/Ball Hk

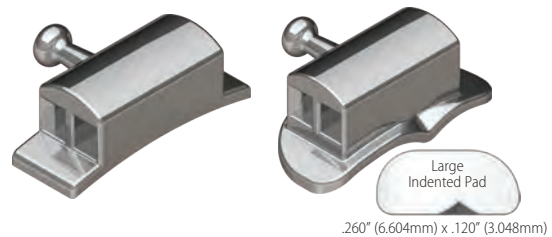

Maxillary and/or Mandibular 1st Molar

Torque	Offset	Rx	HG I.D.	M/D	R/L	Weldable		Bondable	
						.018	.022	.018	.022
0°	0°	--	--	3.5 mm	UL/LR	NRD1-819	–	NRD1B-819E	–
					UR/LL	NRD1-820	–	NRD1B-820E	–

*G&H® prescriptions are not implied to be an exact version of any other system, nor do we claim any endorsement by the doctor.

Providing a secure fit you can count on!

Precision-shaped tooth anatomy for a tight, secure fit and excellent retention, time after time.

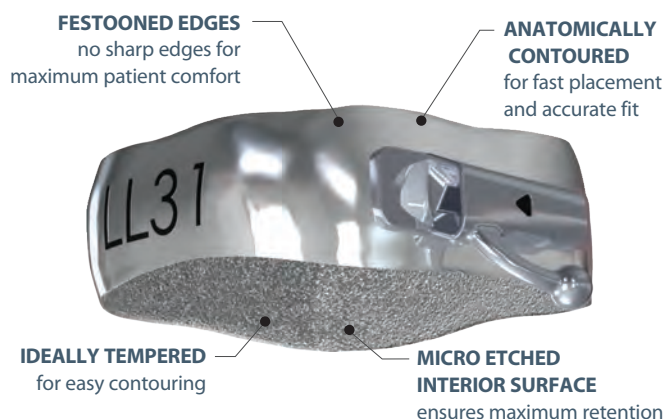

FEATURES INCLUDE:

- Precision-shaped tooth anatomy for a tight, secure fit with excellent retention. Our distinct right and left anatomy is completely proportioned in all planes and for each band size.
- Stainless steel that exhibits properties of “hardness” for strength to avoid wall collapse when fitting, yet is malleable enough for “snap” fitting that requires little or no burnishing.
- Increased buccal height for greater flexibility in the placement and positioning of buccal tubes and lingual attachments.
- Interiors are micro-etched to provide a rough ended surface for increased bond strength.
- Permanently etched using an Electro Chemical Etching process for easy permanent identification.
- 36 upper and lower sizes graduated in even, closely spaced increments for improved fit. Saturn Bands are available in 36 sizes (*full-size increments*) and Titan Bands are available in 30 sizes (*half-size increments*).

Whether you are upgrading from your current band system or are just starting out, G&H has a band system to meet your specifications. Manufactured under stringent quality control measures, you can count on Titan and Saturn Anatomical Molar Band Systems to meet the demands of your orthodontic practice.

FREE PREWELDING SERVICE

Ordering bands with attachments can be a time consuming process, not to mention the time and expertise required to weld the attachment. G&H® offers complimentary welding with all of our appliances.

When we receive an order, the weld specifications are kept on file so reorders utilizing the same appliances and weld specifications can be simplified by asking us to duplicate your last order. We can even provide you with our order form to further facilitate processing.

G&H® also offers “custom” welding to meet specific prescriptions. However, you will find that our standard weld specifications will satisfy most prescriptions. Additionally, we will weld appliances from other companies at a nominal charge, but the appliances and weld specifications must be submitted when the order is placed.

Also available –

Band Seating Instruments - (*See page 121*)



Plastic Band Organizer with Lid

Plastic band organizers are designed for proper band storage and will fit most band cabinets. Included with kit purchase.

Titan™ Plastic Band Organizer **M620-01**
(Sizes 29 1/2 to 44)

Saturn™ Plastic Band Organizer **M630-01**
(Sizes 1 to 32)

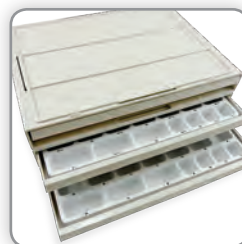

Stackable Band Organizer

- Modular interlocking design
- Constructed with high quality durable plastic
- Accommodates our plastic band organizer (ordered separately)

Stackable Band Organizer **S407-01**

Titan™ Molar Bands



Individual Titan™ Molar Bands

Size	Maxillary 1 st & 2 nd Molar		Mandibular 1 st Molar		Mandibular 2 nd Molar	
	Left	Right	Left	Right	Left	Right
29.5	B10-UL-295	B10-UR-295	B10-LL-295	B10-LR-295	B11-LL-295	B11-LR-295
30	B10-UL-300	B10-UR-300	B10-LL-300	B10-LR-300	B11-LL-300	B11-LR-300
30.5	B10-UL-305	B10-UR-305	B10-LL-305	B10-LR-305	B11-LL-305	B11-LR-305
31	B10-UL-310	B10-UR-310	B10-LL-310	B10-LR-310	B11-LL-310	B11-LR-310
31.5	B10-UL-315	B10-UR-315	B10-LL-315	B10-LR-315	B11-LL-315	B11-LR-315
32	B10-UL-320	B10-UR-320	B10-LL-320	B10-LR-320	B11-LL-320	B11-LR-320
32.5	B10-UL-325	B10-UR-325	B10-LL-325	B10-LR-325	B11-LL-325	B11-LR-325
33	B10-UL-330	B10-UR-330	B10-LL-330	B10-LR-330	B11-LL-330	B11-LR-330
33.5	B10-UL-335	B10-UR-335	B10-LL-335	B10-LR-335	B11-LL-335	B11-LR-335
34	B10-UL-340	B10-UR-340	B10-LL-340	B10-LR-340	B11-LL-340	B11-LR-340
34.5	B10-UL-345	B10-UR-345	B10-LL-345	B10-LR-345	B11-LL-345	B11-LR-345
35	B10-UL-350	B10-UR-350	B10-LL-350	B10-LR-350	B11-LL-350	B11-LR-350
35.5	B10-UL-355	B10-UR-355	B10-LL-355	B10-LR-355	B11-LL-355	B11-LR-355
36	B10-UL-360	B10-UR-360	B10-LL-360	B10-LR-360	B11-LL-360	B11-LR-360
36.5	B10-UL-365	B10-UR-365	B10-LL-365	B10-LR-365	B11-LL-365	B11-LR-365
37	B10-UL-370	B10-UR-370	B10-LL-370	B10-LR-370	B11-LL-370	B11-LR-370
37.5	B10-UL-375	B10-UR-375	B10-LL-375	B10-LR-375	B11-LL-375	B11-LR-375
38	B10-UL-380	B10-UR-380	B10-LL-380	B10-LR-380	B11-LL-380	B11-LR-380
38.5	B10-UL-385	B10-UR-385	B10-LL-385	B10-LR-385	B11-LL-385	B11-LR-385
39	B10-UL-390	B10-UR-390	B10-LL-390	B10-LR-390	B11-LL-390	B11-LR-390
39.5	B10-UL-395	B10-UR-395	B10-LL-395	B10-LR-395	B11-LL-395	B11-LR-395
40	B10-UL-400	B10-UR-400	B10-LL-400	B10-LR-400	B11-LL-400	B11-LR-400
40.5	B10-UL-405	B10-UR-405	B10-LL-405	B10-LR-405	B11-LL-405	B11-LR-405
41	B10-UL-410	B10-UR-410	B10-LL-410	B10-LR-410	B11-LL-410	B11-LR-410
41.5	B10-UL-415	B10-UR-415	B10-LL-415	B10-LR-415	B11-LL-415	B11-LR-415
42	B10-UL-420	B10-UR-420	B10-LL-420	B10-LR-420	B11-LL-420	B11-LR-420
42.5	B10-UL-425	B10-UR-425	B10-LL-425	B10-LR-425	B11-LL-425	B11-LR-425
43	B10-UL-430	B10-UR-430	B10-LL-430	B10-LR-430	-	-
43.5	B10-UL-435	B10-UR-435	B10-LL-435	B10-LR-435	-	-
44	B10-UL-440	B10-UR-440	B10-LL-440	B10-LR-440	-	-

BAND SEATING INSTRUMENTS AVAILABLE ON PAGE 121



Titan™ Molar Band Kits

G&H® has taken the guesswork out of ordering a band kit. Each band kit includes left and right molar bands graduated in even, closely spaced increments. Choose from four kit assortments:

Trial Kit

80 Total Bands
40 Lefts and 40 Rights
Sizes 32-39

Intro Kit

150 Total Bands
75 Lefts and 75 Rights
Sizes 29½ - 44

Pro Kit

300 Total Bands
150 Lefts and 150 Rights
Sizes 29½ - 44

Master Kit

600 Total Bands
300 Lefts and 300 Rights
Sizes 29½ - 44

Kits include a plastic band organizer.



Maxillary 1st & 2nd Molar Bands

Catalog No./Type	29%	30	30½	31	31½	32	32½	33	33½	34	34½	35	35½	36	36½	37	37½	38	38½	39	39½	40	40½	41	41½	42	42½	43	43½	44	
K10-UP-TRIAL (80)	-	-	-	-	-	2	2	4	4	4	6	6	10	10	10	6	6	4	4	2	-	-	-	-	-	-	-	-	-	-	-
K10-UP-INTRO (150)	2	2	2	2	2	2	4	4	6	8	10	10	10	10	12	12	10	8	6	4	4	4	2	2	2	2	2	2	2	2	2
K10-UP-PRO (300)	4	4	4	4	4	4	8	8	12	16	20	20	20	20	24	24	20	16	12	8	8	8	4	4	4	4	4	4	4	4	4
K10-UP-MASTER (600)	8	8	8	8	8	8	16	16	24	32	40	40	40	40	48	48	40	32	24	16	16	16	8	8	8	8	8	8	8	8	8

Mandibular 1st Molar Bands

Catalog No./Type	29%	30	30½	31	31½	32	32½	33	33½	34	34½	35	35½	36	36½	37	37½	38	38½	39	39½	40	40½	41	41½	42	42½	43	43½	44	
K10-LO-TRIAL (80)	-	-	-	-	-	2	2	4	4	4	6	6	10	10	10	6	6	4	4	2	-	-	-	-	-	-	-	-	-	-	
K10-LO-INTRO (150)	2	2	2	2	2	2	4	4	6	8	10	10	10	10	12	12	10	8	6	4	4	4	2	2	2	2	2	2	2	2	
K10-LO-PRO (300)	4	4	4	4	4	4	8	8	12	16	20	20	20	20	24	24	20	16	12	8	8	8	4	4	4	4	4	4	4	4	4
K10-LO-MASTER (600)	8	8	8	8	8	8	16	16	24	32	40	40	40	40	48	48	40	32	24	16	16	16	8	8	8	8	8	8	8	8	8

Mandibular 2nd Molar Bands

Catalog No./Type	29%	30	30½	31	31½	32	32½	33	33½	34	34½	35	35½	36	36½	37	37½	38	38½	39	39½	40	40½	41	41½	42
K11-LO-TRIAL (80)	-	-	-	-	-	2	2	4	4	4	6	6	10	10	10	6	6	4	4	-	-	-	-	-	-	-
K11-LO-INTRO (150)	2	2	2	2	2	2	4	6	8	8	10	10	10	10	12	12	10	8	8	6	4	4	2	2	2	2
K11-LO-PRO (300)	4	4	4	4	6	8	8	8	12	14	16	18	20	24	24	24	20	18	16	12	10	6	6	6	4	4
K11-LO-MASTER (600)	8	8	8	8	12	16	18	22	26	32	40	40	48	48	48	40	36	30	24	20	16	12	12	12	8	8

Saturn™ Molar & Bicuspid Bands

Individual Saturn™ Molar Bands

Saturn™ Bicuspid Bands

Size	Maxillary 1 st & 2 nd Molar		Mandibular 1 st Molar		Mandibular 2 nd Molar		Upper/Lower Bicuspid	
	Left	Right	Left	Right	Left	Right	Upper	Lower
1	B12-UL-01	B12-UR-01	B12-LL-01	B12-LR-01	B13-LL-01	B13-LR-01	B22-UP-01	B24-LO-01
2	B12-UL-02	B12-UR-02	B12-LL-02	B12-LR-02	B13-LL-02	B13-LR-02	B22-UP-02	B24-LO-02
3	B12-UL-03	B12-UR-03	B12-LL-03	B12-LR-03	B13-LL-03	B13-LR-03	B22-UP-03	B24-LO-03
4	B12-UL-04	B12-UR-04	B12-LL-04	B12-LR-04	B13-LL-04	B13-LR-04	B22-UP-04	B24-LO-04
5	B12-UL-05	B12-UR-05	B12-LL-05	B12-LR-05	B13-LL-05	B13-LR-05	B22-UP-05	B24-LO-05
6	B12-UL-06	B12-UR-06	B12-LL-06	B12-LR-06	B13-LL-06	B13-LR-06	B22-UP-06	B24-LO-06
7	B12-UL-07	B12-UR-07	B12-LL-07	B12-LR-07	B13-LL-07	B13-LR-07	B22-UP-07	B24-LO-07
8	B12-UL-08	B12-UR-08	B12-LL-08	B12-LR-08	B13-LL-08	B13-LR-08	B22-UP-08	B24-LO-08
9	B12-UL-09	B12-UR-09	B12-LL-09	B12-LR-09	B13-LL-09	B13-LR-09	B22-UP-09	B24-LO-09
10	B12-UL-10	B12-UR-10	B12-LL-10	B12-LR-10	B13-LL-10	B13-LR-10	B22-UP-10	B24-LO-10
11	B12-UL-11	B12-UR-11	B12-LL-11	B12-LR-11	B13-LL-11	B13-LR-11	B22-UP-11	B24-LO-11
12	B12-UL-12	B12-UR-12	B12-LL-12	B12-LR-12	B13-LL-12	B13-LR-12	B22-UP-12	B24-LO-12
13	B12-UL-13	B12-UR-13	B12-LL-13	B12-LR-13	B13-LL-13	B13-LR-13	B22-UP-13	B24-LO-13
14	B12-UL-14	B12-UR-14	B12-LL-14	B12-LR-14	B13-LL-14	B13-LR-14	B22-UP-14	B24-LO-14
15	B12-UL-15	B12-UR-15	B12-LL-15	B12-LR-15	B13-LL-15	B13-LR-15	B22-UP-15	B24-LO-15
16	B12-UL-16	B12-UR-16	B12-LL-16	B12-LR-16	B13-LL-16	B13-LR-16	B22-UP-16	B24-LO-16
17	B12-UL-17	B12-UR-17	B12-LL-17	B12-LR-17	B13-LL-17	B13-LR-17	B22-UP-17	B24-LO-17
18	B12-UL-18	B12-UR-18	B12-LL-18	B12-LR-18	B13-LL-18	B13-LR-18	B22-UP-18	B24-LO-18
19	B12-UL-19	B12-UR-19	B12-LL-19	B12-LR-19	B13-LL-19	B13-LR-19	B22-UP-19	B24-LO-19
20	B12-UL-20	B12-UR-20	B12-LL-20	B12-LR-20	B13-LL-20	B13-LR-20	B22-UP-20	B24-LO-20
21	B12-UL-21	B12-UR-21	B12-LL-21	B12-LR-21	B13-LL-21	B13-LR-21	B22-UP-21	B24-LO-21
22	B12-UL-22	B12-UR-22	B12-LL-22	B12-LR-22	B13-LL-22	B13-LR-22	B22-UP-22	B24-LO-22
23	B12-UL-23	B12-UR-23	B12-LL-23	B12-LR-23	B13-LL-23	B13-LR-23	B22-UP-23	B24-LO-23
24	B12-UL-24	B12-UR-24	B12-LL-24	B12-LR-24	B13-LL-24	B13-LR-24	B22-UP-24	B24-LO-24
25	B12-UL-25	B12-UR-25	B12-LL-25	B12-LR-25	B13-LL-25	B13-LR-25	N/A	N/A
26	B12-UL-26	B12-UR-26	B12-LL-26	B12-LR-26	B13-LL-26	B13-LR-26	N/A	N/A
27	B12-UL-27	B12-UR-27	B12-LL-27	B12-LR-27	B13-LL-27	B13-LR-27	N/A	N/A
28	B12-UL-28	B12-UR-28	B12-LL-28	B12-LR-28	B13-LL-28	B13-LR-28	N/A	N/A
29	B12-UL-29	B12-UR-29	B12-LL-29	B12-LR-29	B13-LL-29	B13-LR-29	N/A	N/A
30	B12-UL-30	B12-UR-30	B12-LL-30	B12-LR-30	B13-LL-30	B13-LR-29	N/A	N/A
31	B12-UL-31	B12-UR-31	B12-LL-31	B12-LR-31	B13-LL-31	B13-LR-31	N/A	N/A
32	B12-UL-32	B12-UR-32	B12-LL-32	B12-LR-32	B13-LL-32	B13-LR-32	N/A	N/A
33	B12-UL-33	B12-UR-33	B12-LL-33	B12-LR-33	B13-LL-33	B13-LR-33	N/A	N/A
34	B12-UL-34	B12-UR-34	B12-LL-34	B12-LR-34	B13-LL-34	B13-LR-34	N/A	N/A
35	B12-UL-35	B12-UR-35	B12-LL-35	B12-LR-35	B13-LL-35	B13-LR-35	N/A	N/A
36	B12-UL-36	B12-UR-36	B12-LL-36	B12-LR-36	B13-LL-36	B13-LR-36	N/A	N/A



BAND SEATING INSTRUMENTS AVAILABLE ON PAGE 121

Saturn™ Molar & Bicuspid Band Kits

Trial Kit

80 Total Bands
40 Lefts and 40 Rights
Sizes 6-20

Intro Kit

150 Total Bands
75 Lefts and 75 Rights
Sizes 1-32

Pro Kit

300 Total Bands
150 Lefts and 150 Rights
Sizes 1-32

Master Kit

600 Total Bands
300 Lefts and 300 Rights
Sizes 1-32

Kit quantities include half left and half right.
Kits include a plastic band organizer.

Maxillary 1st & 2nd Molar Bands

Catalog No./Type	1	2	3	4	5	6	7	8	9	10	11	12	13	14	15	16	17	18	19	20	21	22	23	24	25	26	27	28	29	30	31	32	
K12-UP-TRIAL (80)	-	-	-	-	-	2	2	4	4	4	6	6	10	10	10	6	6	4	4	2	-	-	-	-	-	-	-	-	-	-	-	-	-
K12-UP-INTRO (150)	2	2	2	2	2	2	4	4	6	8	8	10	10	10	12	10	10	8	6	4	4	4	2	2	2	2	2	2	2	2	2	2	
K12-UP-PRO (300)	4	4	4	4	4	4	8	8	12	16	16	20	20	20	24	20	20	16	12	8	8	8	4	4	4	4	4	4	4	4	4	4	
K12-UP-MASTER (600)	8	8	8	8	8	8	16	16	24	32	32	40	40	40	48	40	40	32	24	16	16	16	8	8	8	8	8	8	8	8	8	8	

Mandibular 1st Molar Bands

Catalog No./Type	1	2	3	4	5	6	7	8	9	10	11	12	13	14	15	16	17	18	19	20	21	22	23	24	25	26	27	28	29	30	31	32
K12-LO-TRIAL (80)	-	-	-	-	-	2	2	4	4	4	6	6	10	10	10	6	6	4	4	2	-	-	-	-	-	-	-	-	-	-	-	-
K12-LO-INTRO (150)	2	2	2	2	2	2	4	4	6	8	8	10	10	10	12	10	10	8	6	4	4	4	2	2	2	2	2	2	2	2	2	2
K12-LO-PRO (300)	4	4	4	4	4	4	8	8	12	16	16	20	20	20	24	20	20	16	12	8	8	8	4	4	4	4	4	4	4	4	4	4
K12-LO-MASTER (600)	8	8	8	8	8	8	16	16	24	32	32	40	40	40	48	40	40	32	24	16	16	16	8	8	8	8	8	8	8	8	8	8

Mandibular 2nd Molar Bands

Catalog No./Type	1	2	3	4	5	6	7	8	9	10	11	12	13	14	15	16	17	18	19	20	21	22	23	24	25	26	27	28	29	30	31	32
K13-LO-TRIAL (80)	-	-	-	-	-	2	2	4	4	4	6	6	10	10	10	6	6	4	4	2	-	-	-	-	-	-	-	-	-	-	-	-
K13-LO-INTRO (150)	2	2	2	2	2	2	4	4	6	8	8	10	10	10	12	10	10	8	6	4	4	4	2	2	2	2	2	2	2	2	2	2
K13-LO-PRO (300)	4	4	4	4	4	4	8	8	12	16	16	20	20	20	24	20	20	16	12	8	8	8	4	4	4	4	4	4	4	4	4	4
K13-LO-MASTER (600)	8	8	8	8	8	8	16	16	24	32	32	40	40	40	48	40	40	32	24	16	16	16	8	8	8	8	8	8	8	8	8	8

SATURN™ BICUSPID BANDS

All Saturn™ bicuspid bands are permanently etched using an electro Chemical Etching process for easy permanent identification. Interiors are micro-etched for roughness to increase bond strength.

Maxillary 1st & 2nd Bicuspid Bands

Catalog No./Type	1	2	3	4	5	6	7	8	9	10	11	12	13	14	15	16	17	18	19	20	21	22	23	24
K22-UP-TRIAL (80)	-	-	2	2	2	4	4	4	6	6	6	8	8	6	4	4	4	2	2	2	2	2	-	-
K22-UP-INTRO (150)	2	2	4	4	4	6	6	8	10	10	12	12	12	10	10	8	6	6	4	4	4	2	2	2
K22-UP-PRO (300)	4	4	8	8	8	12	12	16	20	20	24	24	24	20	20	16	12	12	8	8	8	4	4	4
K22-UP-MASTER (600)	8	8	16	16	16	24	24	32	40	40	48	48	48	40	40	32	24	24	16	16	16	8	8	8

Mandibular 1st & 2nd Bicuspid Bands

Catalog No./Type	1	2	3	4	5	6	7	8	9	10	11	12	13	14	15	16	17	18	19	20	21	22	23	24
K24-LO-TRIAL (80)	-	-	2	2	2	4	4	4	6	6	6	8	8	6	4	4	4	2	2	2	2	2	-	-
K24-LO-INTRO (150)	2	2	4	4	4	6	6	8	10	10	12	12	12	10	10	8	6	6	4	4	4	2	2	2
K24-LO-PRO (300)	4	4	8	8	8	12	12	16	20	20	24	24	24	20	20	16	12	12	8	8	8	4	4	4
K24-LO-MASTER (600)	8	8	16	16	16	24	24	32	40	40	48	48	48	40	40	32	24	24	16	16	16	8	8	8

Auxiliary Attachments

Freddy™ By Gestenco International AB

Ceramic Buttons

10/pkg.

Maintains the transparent look with aligners as anchorage for elastics. Works lingually & labially. Anatomical mesh base for strong bond fits all teeth. **CLB10**



Freddy™ By Gestenco International AB

Ceramic Hook

10/pkg.

Introducing the Freddy Hook, a smooth, low profile ellipse shaped clear ceramic hook. An aesthetic auxiliary that matches perfectly to aligner and lingual appliances. **FCB-00-01HK**



Weldable

Lingual Buttons

20/pkg.

Flat
Curved

WLBF20
WLBC20



Direct Bond

Lingual Buttons

20/pkg.

Flat
Curved

BLBF20
BLBC20



Buttons

The domed head allows for maximum patient comfort.

	Weldable	Bondable
Semi-Flat Ea.	M020-01	•
Semi-Flat Low Prof. Ea.	M020-02	•
Mini Ea.	•	M021B-01

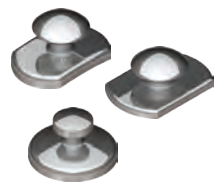

Direct Bond

Lingual Cleats

20/pkg.

Curved

270-212



Weldable

Cleats

Ea.

Short
Long

WLCLEATS
WLCLEATL



Weldable, Universal

Seating Lug

Ea.

M010-04



Lingual Cleats

	Weldable	Bondable
Large 8.1mm Ea.	-	M015B-01
Small 5.3mm Ea.	-	M015B-02
Gull Wing 4.2mm Ea.	M015-03	M015B-03



Weldable

Lingual Sheaths

10/pkg.

.036" Right - w/Hook
.036" Left - w/Hook

WLS055R
WLS055L



Weldable

Lingual Sheaths

Universal
Ea.

M040-01



Weldable, Universal

Lingual Sheaths

With no window, with indent.
Ea.

M040-06



Weldable

Lingual Sheaths

With window, indent, and mesial ball hook.
UR/LL Ea. **M040-04**
UL/LR Ea. **M040-05**



Weldable

Lingual Sheaths

With window, indent and distal ball hook.
UR/LL Ea. **M040-09**
UL/LR Ea. **M040-10**



Eruption Appliance

Extrusion Chain w/Hook

Bondable to cuspid impacted palatally or labially. 14k gold and titanium nitride-coated hook & chain reduces possibility of allergic reactions.

Ea.

EXHK14K



Direct Bond

Coil Eyelets

Round base with .036 inside dia. opening.
Ea.

M006B-01



Stainless Steel Bondable

Extrusion Hook

Mesh pad for secure bonding.

10/pkg.

EXHK



Direct Bond

Composite Eyelets

5/pkg.

CMEYE



Wire Products | Springs

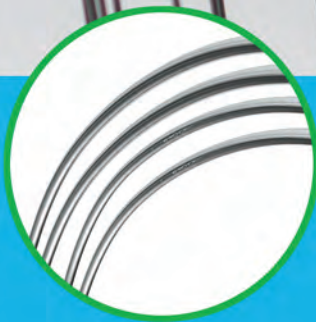

As a wire manufacturer, G&H® maintains total control of all production processes.

Archwire Varieties in Every Alloy Precision manufactured by G&H® in the U.S.A.

TOP SELLER!



G4™ NICKEL TITANIUM
Available in:

- All Archforms
- Pre-Stopped
- Lingual Arches
- Pre-Torqued
- G4orce™ Triple Force
- Ultraesthetic™ Tooth-Colored
- Reverse Curve

TOP SELLER!



M5™ THERMAL COPPER NICKEL TITANIUM
Available in:

- All Archforms
- Pre-Stopped
- Lingual Arches
- Reverse Curve

TOP SELLER!



TitanMoly™ TITANIUM MOLYBDENUM
(Previously called BT3™ Beta Titanium)
Available in:

- 5 Archforms
- T-Loop
- Lingual Arches

TOP SELLER!



S304 VM STAINLESS STEEL
Available in:

- All Archforms
- Ultraesthetic™ Tooth-Colored
- Lingual Arches

XR1™ HEAT-TREATED STAINLESS STEEL
Available in:

- All Archforms
- Brass Ball-Post Posted Arches

ULTRAESTHETIC™ TOOTH-COLORED
Available in:

- 5 Archforms
- G4™ NiTi
- Stainless Steel
- Reverse Curve
- Pre-Stopped

MULTI-STRAND STAINLESS STEEL
Available in:

- 2 Archforms
- Four Strand Varieties:
 - 3-Strand (twisted)
 - 6-Strand (coaxial)
 - 7-Strand (twisted)
 - 8-Strand (woven)

REVERSE CURVE NICKEL TITANIUM
Available in:

- RC 1 & 3
- Europa™ II
- Pre-Stopped
- Pre-Torqued
- Thermal Copper
- Ultraesthetic™ Tooth-Colored

LOOPED STAINLESS STEEL
Available in:

- Trueform™
- T-Loop
- Keyhole Loop

POSTED STAINLESS STEEL
Available in:

- 4 Archforms
- Heat-Treated w/Brass Ball-Post
- Straight Brass Post



G&H Solo-Pack™ autoclavable packaging

G&H is at the forefront in the industry in providing autoclavable, individual archwire packaging consistent with the highest standards of hygiene.

Archwire Pack Storage Boxes

These storage containers give you the ability to neatly organize your archwire products from G&H. Bulk wire box holds up to 60 archwire sleeves Solo-Pack™ box holds up to 24 solo-pack™ boxes. Each box Includes 10 dividers which allows you to separate wires by type. Boxes sold separately. (Archwires not included)

Dimensions: Bulk box - 2.5"W x 7"L x 3"H.
Solo-Pack™ box - 3½"W x 12"L x 3"H

Bulk wire box **AWSCSLD**
Solo-Pack™ box **AWSCSOD**



Archform Templates

Sturdy clear plastic cards with G&H archform shapes of our most popular forms. Easily compare wire shapes to template, or use to match shape when forming archwires, or overlay on models. Kits include 2 cards: (1) template of NiTi form and (1) template of stainless steel form. (Archwires not included)

Dimensions: 3½"W x 4"H

Trueform™ Kit: **GHTFIKTC**
Europa™ I Kit: **GHEFIKTC**
Europa™ II Kit: **GHEFIIKTC**
Bioform III Kit: **GHBFIIKTC**
Standard Form Kit: **GHFSKTC**



Our Most Popular Archforms

ARCHFORMS ARE PICTURED ACTUAL SIZE.

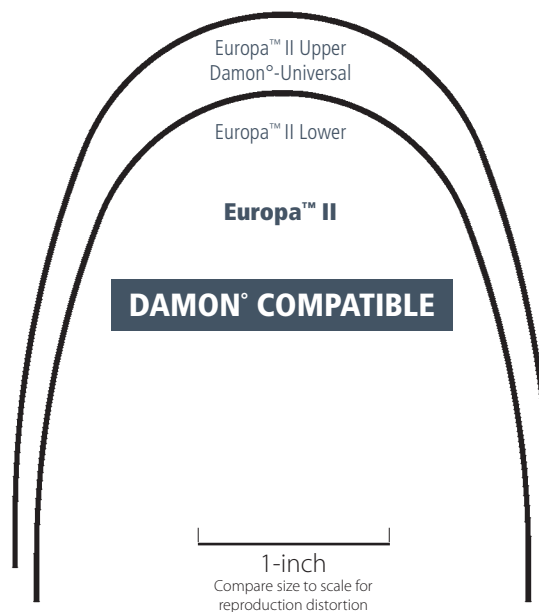
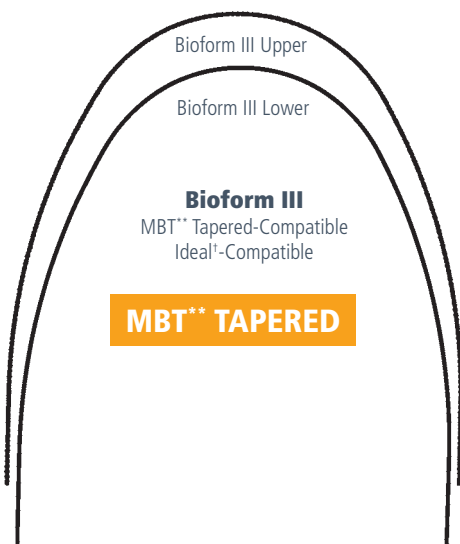
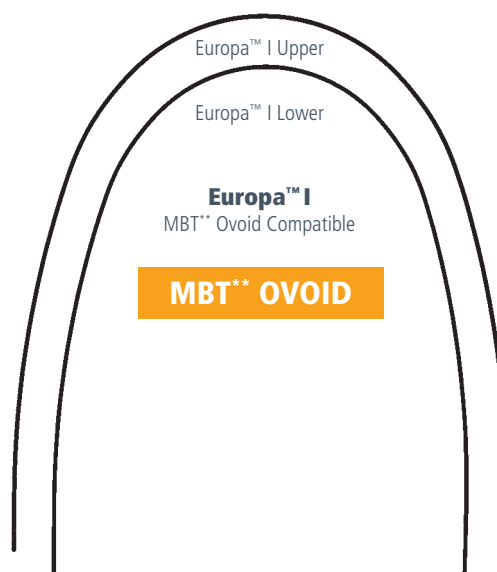
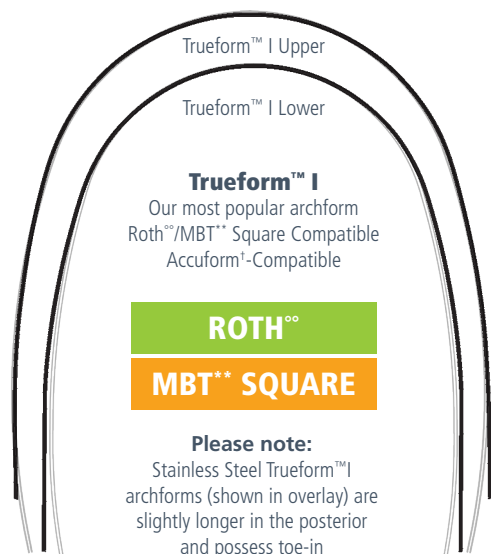

Archwire Dispenser

Our archwire dispenser organizes up to 12 sets of archwires neatly and efficiently. Manufactured of anodized aluminum, this rack can be thoroughly cleaned and sterilized as desired. Light weight and attractive, this dispenser will compliment any office décor. 3¼" wide x 7¼" long x 1¼" high

Anodized aluminum **AWDSA100**



°G&H® Orthodontics is in no way affiliated with or endorsed by Ormco Corporation or Dr. Dwight Damon.

**MBT is a trademark of 3M Unitek.

¹Accuform & Ideal are registered trademarks of Dentsply GAC International.

°°G&H® prescriptions are not implied to be an exact version of any other system, nor do we claim any endorsement by the doctor.

33 ARCHFORM OPTIONS AVAILABLE!

See page 79 for additional archforms.

See & download our complete variety of archform shapes at: GHOrthodontics.com

Permanent, electro-etched midline ID

- Three-etch lines for UPPER
- One-etch line for LOWER

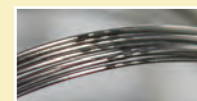

Material Science / Scientific Testing

G&H® NiTi archwires deliver the clinical expectations of extreme elasticity, consistent force, and shape memory, realized over a range of deflection.

G&H® Orthodontics is a recognized leader in manufacturing Nickel Titanium wire products. Continuous and meticulous testing of our wires ensures the high standards of performance we guarantee. State-of-the-art stress/strain testing of Nickel Titanium wire is performed employing a three-point deflection test (fig. A) with a load cell probe impacting a wire and recording the forces throughout the range from deflection to recovery. The test data (force vs. deflection) is validated on a daily basis to meet our stringent specifications. The data is then documented and archived on a hysteresis graph (fig. B).



How a Hysteresis Graph demonstrates if a NiTi wire will fulfill the clinical expectations of **elasticity**, **consistent force** and **shape memory**.

- 1 Start test – Load cell contacts wire and begins deflection in 37 °C waterbath
- 2 **Extreme elasticity** shown by the Load Resistance Force (bump in the graph) at 0.6mm deflection
 - This wire is active and aggressive as it transitions from the Austenitic (increasing force) to Martensitic (constant force) state
- 3 **Consistent forces** of Martensitic response
 - Engagement forces have "flatlined" at 230g as the wire is deflected from 0.6mm to 2.0mm
 - Desired, defined excursion of Martensitic phenomenon (constant force over a large deflection) exhibited represents properties unique to effective Superelastic Niti wire
- 4 **Extreme elasticity** and **consistent force** shown at 3.0mm deflection
 - Peak load force of 230g at 2.0mm deflection is consistent with force levels at the 0.6mm deflection point during engagement
 - Transitional rebound shows the wire is active and aggressive as engagement forces cease and recovery forces begin applying tooth moving force
- 5 **Consistent unload force** as Martensitic state is reentered during recovery
 - Tooth moving forces dissipate slightly then stabilize to ensure consistent unload to shape memory.
- 6 **Shape memory** and **elasticity** are expressed
 - Full shape memory rebound occurs at 130g ensuring continuity of effective tooth moving forces through complete shape recovery

(fig. A)

Three-point deflection testing to measure force values

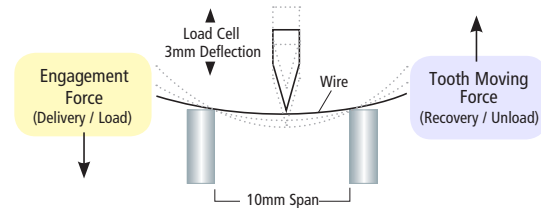

ANSI/ADA Specifications #32, Orthodontic Wires: 2006

Hysteresis Graph (fig. B)

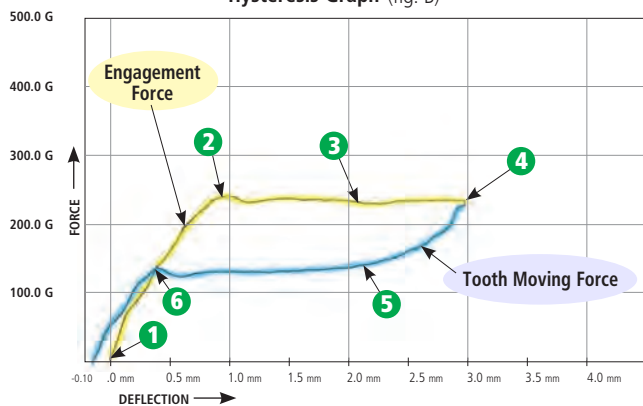

Description: .016 G4™ Niti Test Temp: 37 °C

Force Value Graphs of G&H® Archwires

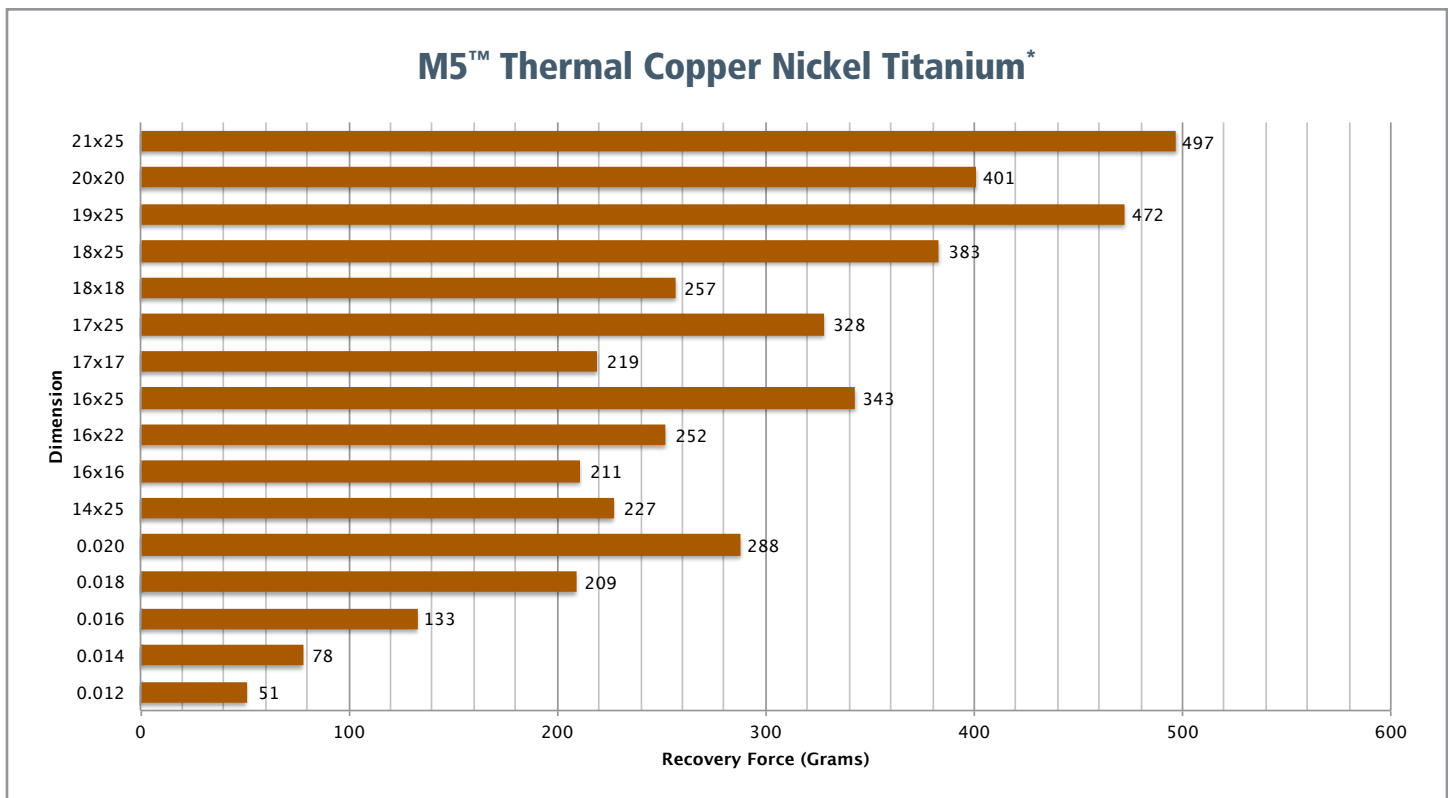
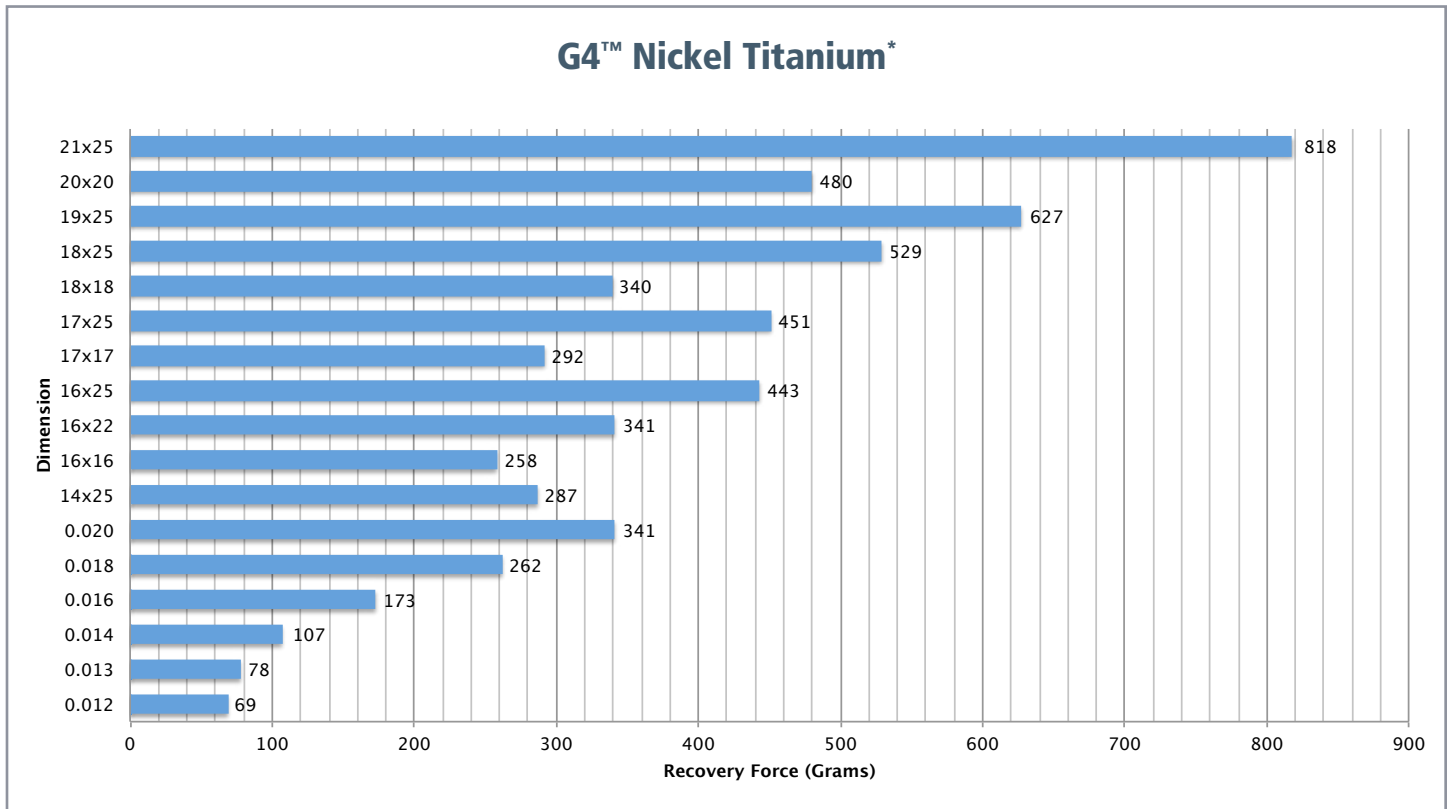

*ANSI/ADA Specifications #32, Orthodontic Wires: 2006

Force Value Graphs of G&H® Archwires

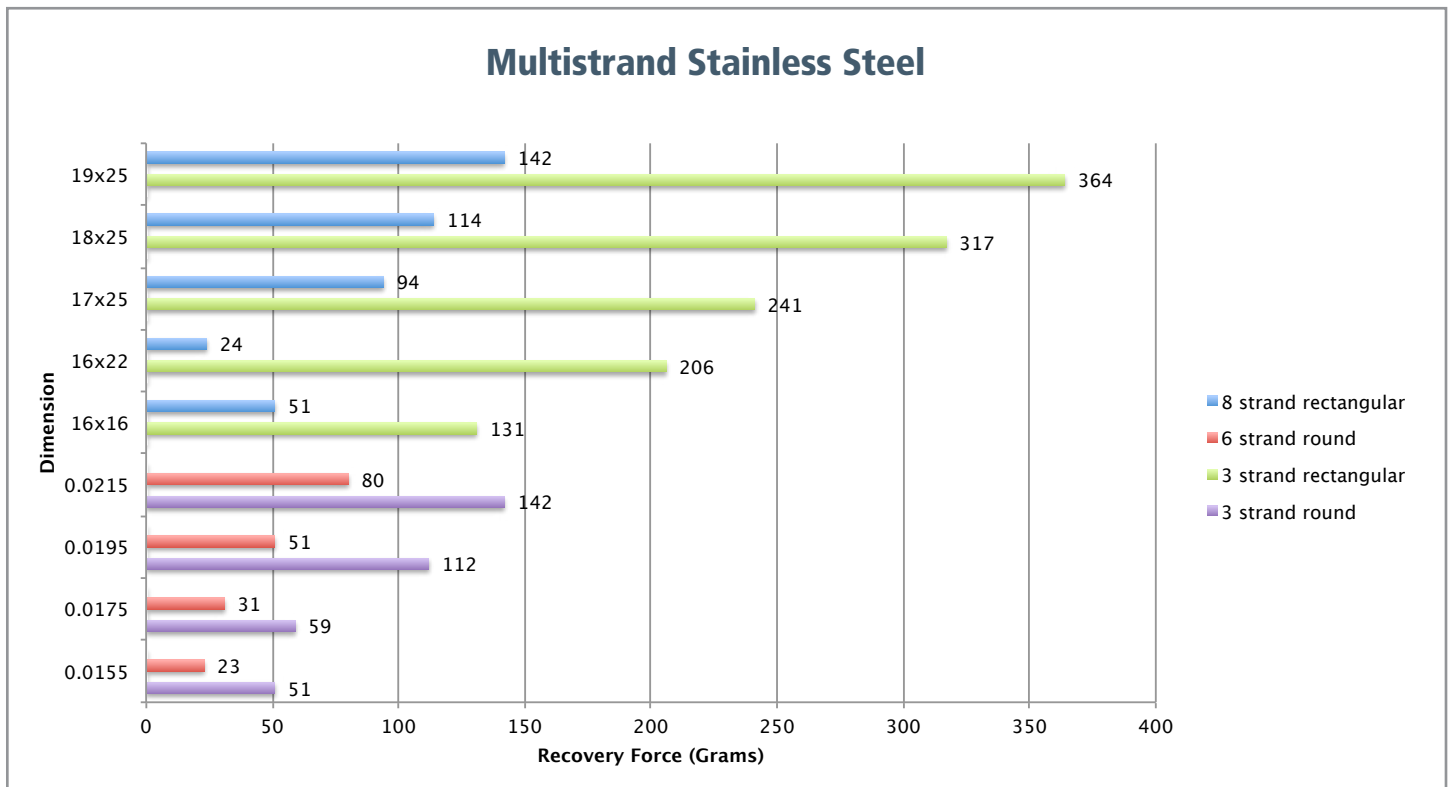
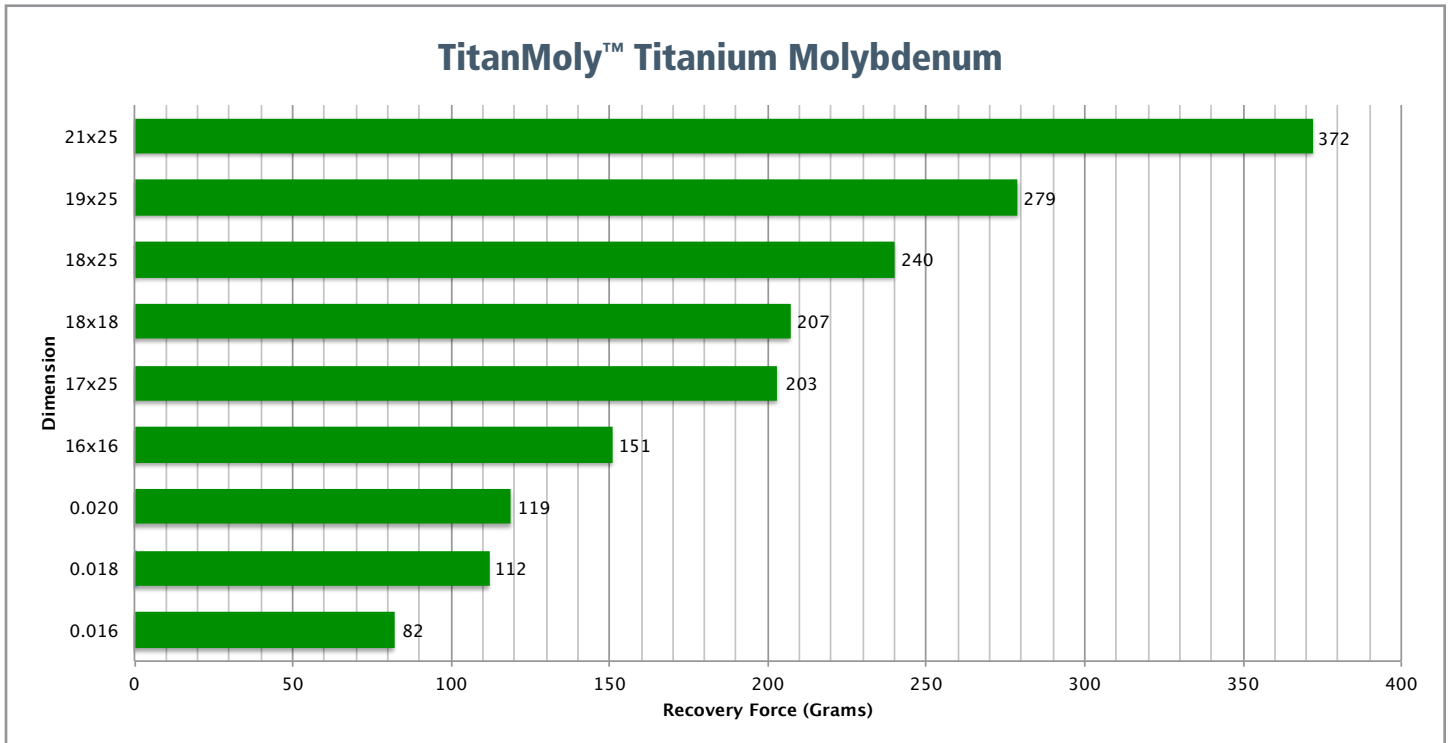

Force Value Graphs of G&H® Archwires

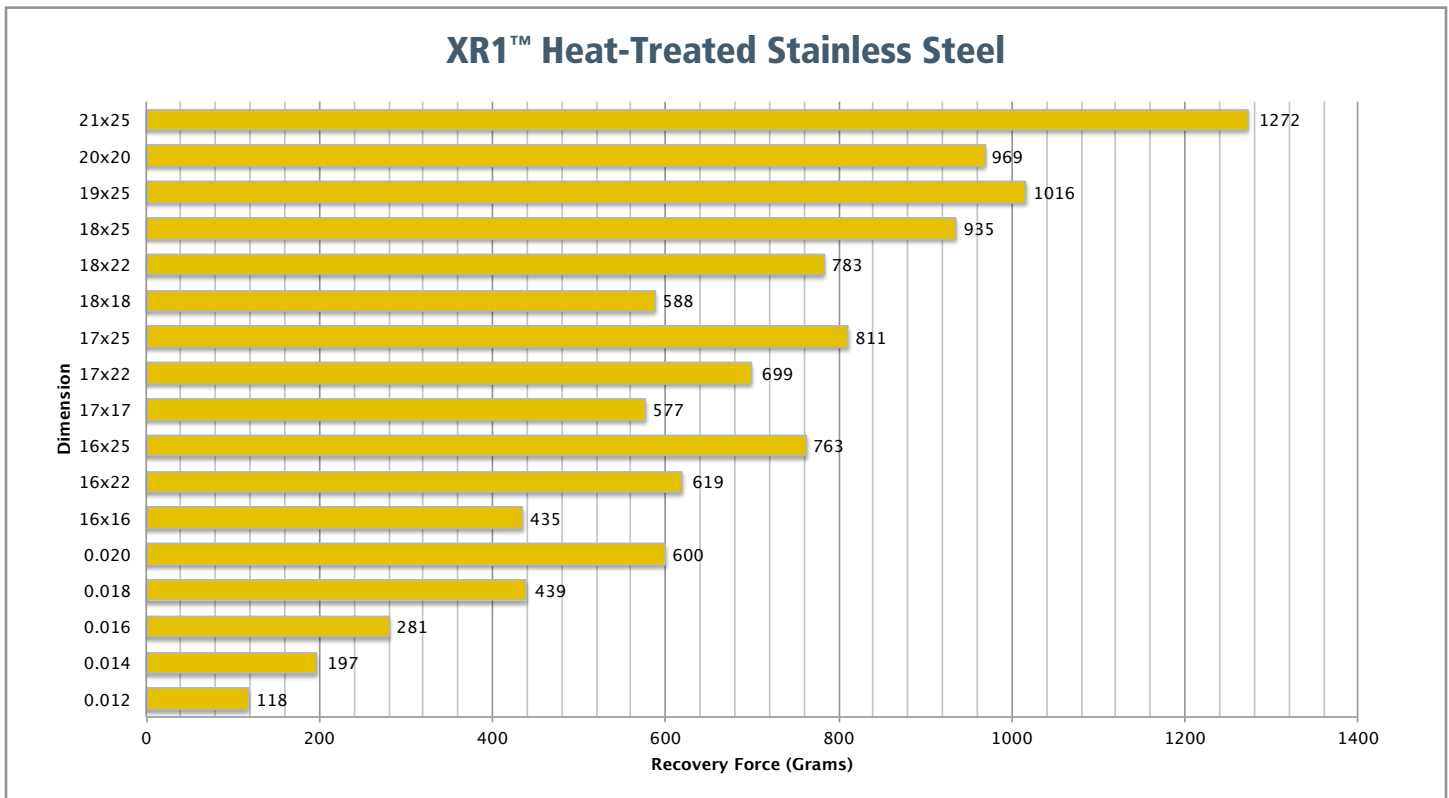
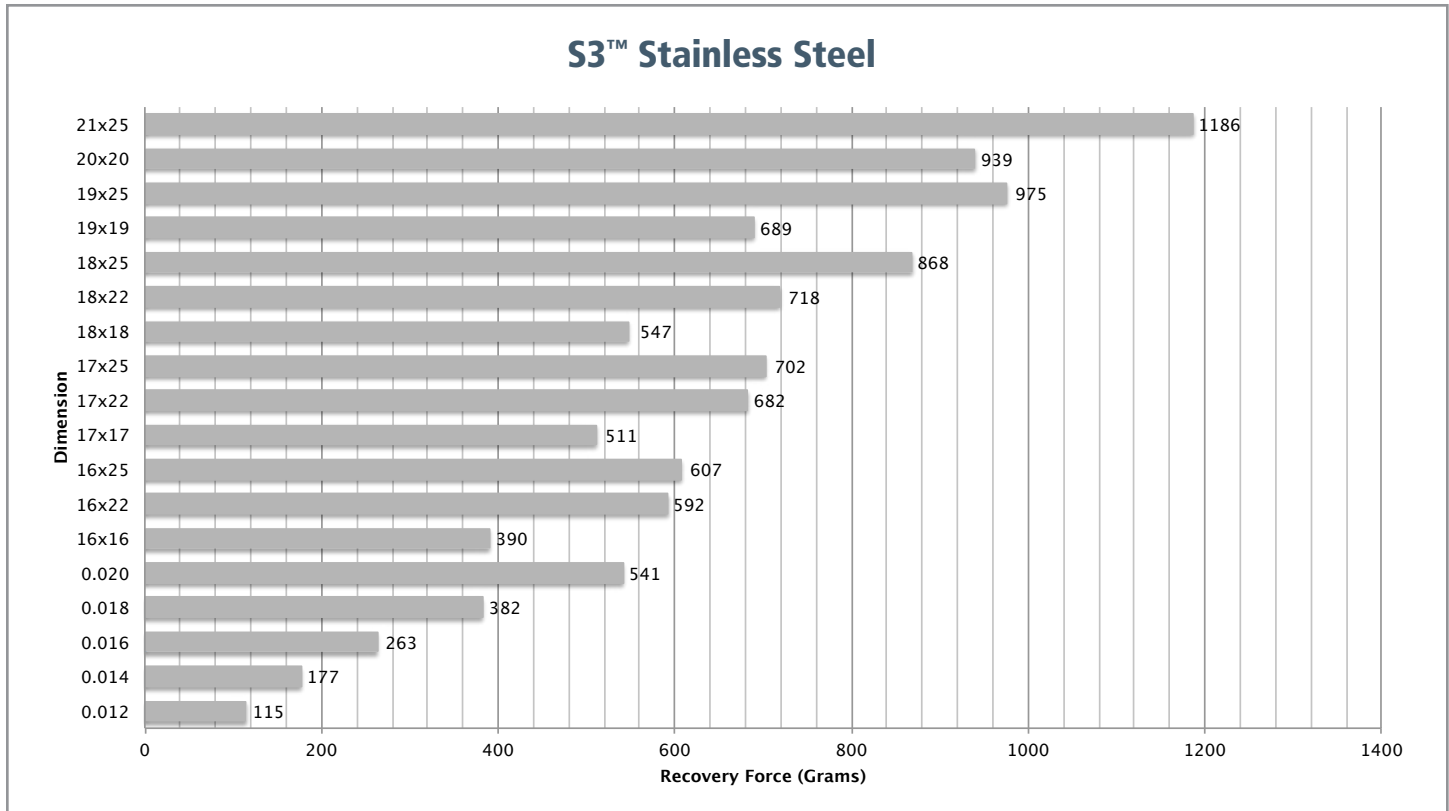

G&H® MAKES OUR WIRES, AND THAT MAKES THE DIFFERENCE

G&H is recognized as the world's best manufacturer of premium archwires and G&H precision manufacturing processes make the difference.

- Quality, precision manufactured in the U.S.A.
- Material science and engineering
- Sourcing of premium alloy materials
- Scientific testing protocols
- Proven clinical performance for more than 40 years



SCIENTIFIC TESTING PROTOCOLS

Continuous, meticulous testing of each lot with 14 separate quality tests. Then, our wire undergoes a rigorous 28-point final inspection before packaging. Our wires successfully pass all testing so that performance characteristics can be guaranteed.

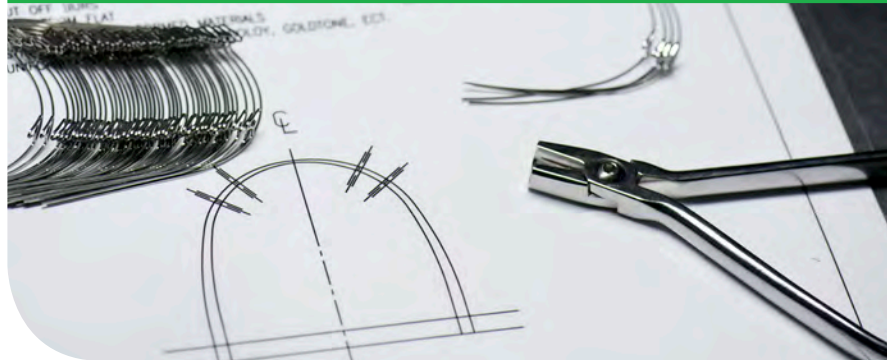

G4™ Nickel Titanium Archwires Precision Manufactured By G&H® Orthodontics



G4™ NiTi wire provides lower initial load forces and increased residual forces as full shape recovery progresses. Teeth move farther and faster.

- Higher residual forces of recovery
- Full shape recovery
- Complete unraveling and archform development
- Stays active to the end - moves teeth the last 1/2mm

ALSO AVAILABLE On Pg.

- Tooth-Colored - 56
- Pre-stopped - 57
- Pre-torqued - 58
- Triple Force - 59
- Reverse Curve - 60
- Lingual - 71
- Dimpled Midline (see below)

SIZE	ROTH ^{°°}		Full-size archform shapes on page 49.					
	MBT ^{**} SQUARE		MBT ^{**} OVOID		MBT ^{**} TAPERED		DAMON [°] -COMPATIBLE	
	TRUEFORM™ I		EUROPA™ I		BIOFORM III		EUROPA™ II	
	UPPER	LOWER	UPPER	LOWER	UPPER	LOWER	UPPER	LOWER
.012	G4TFU012	G4TFL012	G4EFU012	G4EFL012	G4BF3U012	G4BF3L012	G4EFU112	G4EFL112
.013	–	–	G4EFU013	G4EFL013	–	–	G4EFU113	G4EFL113
.014	G4TFU014	G4TFL014	G4EFU014	G4EFL014	G4BF3U014	G4BF3L014	G4EFU114	G4EFL114
.016	G4TFU016	G4TFL016	G4EFU016	G4EFL016	G4BF3U016	G4BF3L016	G4EFU116	G4EFL116
.018	G4TFU018	G4TFL018	G4EFU018	G4EFL018	G4BF3U018	G4BF3L018	G4EFU118	G4EFL118
.020	G4TFU020	G4TFL020	G4EFU020	G4EFL020	G4BF3U020	G4BF3L020	G4EFU120	G4EFL120
.014x.025	G4TFU1425	–	G4EFU1425	G4EFL1425	–	–	G4EFU3425	G4EFL3425
.016x.016	G4TFU1616	G4TFL1616	G4EFU1616	G4EFL1616	G4BF3U1616	G4BF3L1616	G4EFU3616	G4EFL3616
.016x.022	G4TFU1622	G4TFL1622	G4EFU1622	G4EFL1622	G4BF3U1622	G4BF3L1622	G4EFU3622	G4EFL3622
.016x.025	–	–	G4EFU1625	G4EFL1625	–	–	G4EFU3625	G4EFL3625
.017x.017	–	–	G4EFU1717	G4EFL1717	–	–	G4EFU3717	G4EFL3717
.017x.025	G4TFU1725	G4TFL1725	G4EFU1725	G4EFL1725	G4BF3U1725	G4BF3L1725	G4EFU3725	G4EFL3725
.018x.018	G4TFU1818	G4TFL1818	G4EFU1818	G4EFL1818	G4BF3U1818	G4BF3L1818	G4EFU3818	G4EFL3818
.018x.025	G4TFU1825	G4TFL1825	G4EFU1825	G4EFL1825	G4BF3U1825	G4BF3L1825	G4EFU3825	G4EFL3825
.019x.025	G4TFU1925	G4TFL1925	G4EFU1925	G4EFL1925	G4BF3U1925	G4BF3L1925	G4EFU3925	G4EFL3925
.020x.020	G4TFU2020	G4TFL2020	G4EFU2020	G4EFL2020	G4BF3U2020	G4BF3L2020	G4EFU3020	G4EFL3020
.021x.025	G4TFU2125	G4TFL2125	G4EFU2125	G4EFL2125	G4BF3U2125	G4BF3L2125	G4EFU3125	G4EFL3125
.022x.028	G4TFU2228	G4TFL2228	–	–	–	–	–	–

ORDER OPTIONS



Standard Pack

25 archwires/pack - order numbers as listed.



Optional Solo-Pack™

10 individually sealed autoclavable archwires per carton. For Solo-Pack™ wires, add "S" to the end of part number. Please allow 2-3 days for Solo-Pack™ packaging.

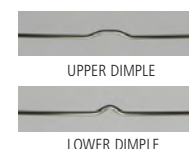

Optional Dimpled Midline

For Dimpled Midline wires, add "D" to the end of part number – for Dimpled Solo-Pack™ add "DS" to the end of part number.

ARCHWIRE CUTTERS & PLIERS BEGIN ON PAGE 119

[°]G&H® Orthodontics is in no way affiliated with or endorsed by Ormco Corporation or Dr. Dwight Damon. ^{**}MBT is a trademark of 3M Unitek. ^{°°}G&H® prescriptions are not implied to be an exact version of any other system, nor do we claim any endorsement by the doctor.

G4™ Tooth-Colored Nickel Titanium Archwires Precision Manufactured By G&H® Orthodontics

The only epoxy coated wires in orthodontics.



As the world's best manufacturer of premium archwires, we use a proprietary epoxy coating which is durable, stain resistant, and just the right shade.

The durable epoxy coating is applied to wires that are .002" smaller for a standard finished dimension.

- Durable epoxy coating
- Stain resistant
- Midline marked
- Available in stainless steel

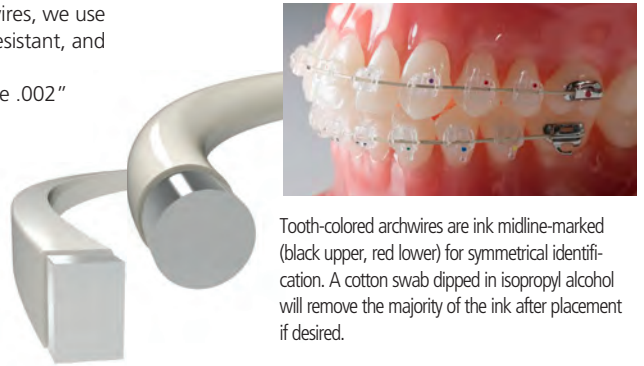

Tooth-colored archwires are ink midline-marked (black upper, red lower) for symmetrical identification. A cotton swab dipped in isopropyl alcohol will remove the majority of the ink after placement if desired.

Full-size archform shapes on page 49.

SIZE	ROTH [®]		MBT ^{**} SQUARE		MBT ^{**} OVOID		MBT ^{**} TAPERED		DAMON [°] -COMPATIBLE	
	TRUEFORM™ I		EUROPA™ I		BIOFORM III		EUROPA™ II			
	UPPER	LOWER	UPPER	LOWER	UPPER	LOWER	UPPER	LOWER	UPPER	LOWER
.012	G4TFU012T	G4TFL012T	G4EFU012T	G4EFL012T	G4BF3U012T	G4BF3L012T	G4EFU112T	G4EFL112T		
.014	G4TFU014T	G4TFL014T	G4EFU014T	G4EFL014T	G4BF3U014T	G4BF3L014T	G4EFU114T	G4EFL114T		
.016	G4TFU016T	G4TFL016T	G4EFU016T	G4EFL016T	G4BF3U016T	G4BF3L016T	G4EFU116T	G4EFL116T		
.018	G4TFU018T	G4TFL018T	G4EFU018T	G4EFL018T	G4BF3U018T	G4BF3L018T	G4EFU118T	G4EFL118T		
.020	G4TFU020T	G4TFL020T	G4EFU020T	G4EFL020T	G4BF3U020T	G4BF3L020T	G4EFU120T	G4EFL120T		
.016x.022	G4TFU1622T	G4TFL1622T	G4EFU1622T	G4EFL1622T	G4BF3U1622T	G4BF3L1622T	G4EFU3622T	G4EFL3622T		
.017x.025	G4TFU1725T	G4TFL1725T	G4EFU1725T	G4EFL1725T	G4BF3U1725T	G4BF3L1725T	G4EFU3725T	G4EFL3725T		
.018x.018	G4TFU1818T	G4TFL1818T	G4EFU1818T	G4EFL1818T	G4BF3U1818T	G4BF3L1818T	G4EFU3818T	G4EFL3818T		
.018x.025	G4TFU1825T	G4TFL1825T	G4EFU1825T	G4EFL1825T	G4BF3U1825T	G4BF3L1825T	G4EFU3825T	G4EFL3825T		
.019x.025	G4TFU1925T	G4TFL1925T	G4EFU1925T	G4EFL1925T	G4BF3U1925T	G4BF3L1925T	G4EFU3925T	G4EFL3925T		
.020x.020	G4TFU2020T	G4TFL2020T	G4EFU2020T	G4EFL2020T	G4BF3U2020T	G4BF3L2020T	G4EFU3020T	G4EFL3020T		
.021x.025	G4TFU2125T	G4TFL2125T	G4EFU2125T	G4EFL2125T	G4BF3U2125T	G4BF3L2125T	G4EFU3125T	G4EFL3125T		

ORDER OPTIONS



Standard Pack

10 archwires/pack - order numbers as listed.



Optional Solo-Pack™

10 individually sealed autoclavable archwires per carton. For Solo-Pack™ wires, add "S" to the end of part number. Please allow 2-3 days for Solo-Pack™ packaging.

ARCHWIRE CUTTERS & PLIERS BEGIN ON PAGE 119

Tooth-Colored Reverse Curve G4™ NiTi

Size	REVERSE CURVE I	
	UPPER	LOWER
.012	G4RCU012T	G4RCL012T
.014	G4RCU014T	G4RCL014T
.016	G4RCU016T	G4RCL016T
.018	G4RCU018T	G4RCL018T
.020	G4RCU020T	G4RCL020T
.016x.022	G4RCU1622T	G4RCL1622T
.017x.025	G4RCU1725T	G4RCL1725T
.018x.018	G4RCU1818T	G4RCL1818T
.018x.025	G4RCU1825T	G4RCL1825T
.019x.025	G4RCU1925T	G4RCL1925T
.020x.020	G4RCU2020T	G4RCL2020T
.021x.025	G4RCU2125T	G4RCL2125T

*G&H® Orthodontics is in no way affiliated with or endorsed by Ormco Corporation or Dr. Dwight Damon. **MBT is a trademark of 3M Unitek.

°G&H® prescriptions are not implied to be an exact version of any other system, nor do we claim any endorsement by the doctor.

G4™ Pre-Stopped Nickel Titanium Archwires Precision Manufactured By G&H® Orthodontics



Eliminates the need to apply stops to archwires. Pre-loaded stops allow positioning as desired, then stay put until crimped. Properly tempered stops crimp easily and securely.

- Eliminate NiTi archwire migration through the slots
- Applicable with all bracket systems and techniques
- Highly indicated for any self-ligating bracket system
- Maintain anterior space consolidation
- Annealed stops crimp evenly and securely
- Pre-loaded stops save chairtime - just position and crimp
- Stops slide and stick for desired positioning prior to crimping



SIZE	ROTH [®]		Full-size archform shapes on page 49.				DAMON [®] -COMPATIBLE	
	MBT ^{**} SQUARE		MBT ^{**} OVOID		MBT ^{**} TAPERED		EUROPA [™] II	
	UPPER	LOWER	UPPER	LOWER	UPPER	LOWER	UPPER	LOWER
.012	G4TFU012CB	G4TFL012CB	G4EFU012CB	G4EFL012CB	G4BF3U012CB	G4BF3L012CB	G4EFU112CB	G4EFL112CB
.013	—	—	—	—	—	—	G4EFU113CB	G4EFL113CB
.014	G4TFU014CB	G4TFL014CB	G4EFU014CB	G4EFL014CB	G4BF3U014CB	G4BF3L014CB	G4EFU114CB	G4EFL114CB
.016	G4TFU016CB	G4TFL016CB	G4EFU016CB	G4EFL016CB	G4BF3U016CB	G4BF3L016CB	G4EFU116CB	G4EFL116CB
.018	G4TFU018CB	G4TFL018CB	G4EFU018CB	G4EFL018CB	G4BF3U018CB	G4BF3L018CB	G4EFU118CB	G4EFL118CB
.020	G4TFU020CB	G4TFL020CB	G4EFU020CB	G4EFL020CB	G4BF3U020CB	G4BF3L020CB	G4EFU120CB	G4EFL120CB
.014x.025	—	—	G4EFU1425CB	G4EFL1425CB	—	—	G4EFU3425CB	G4EFL3425CB
.016x.016	G4TFU1616CB	G4TFL1616CB	G4EFU1616CB	G4EFL1616CB	G4BF3U1616CB	G4BF3L1616CB	G4EFU3616CB	G4EFL3616CB
.016x.022	G4TFU1622CB	G4TFL1622CB	G4EFU1622CB	G4EFL1622CB	G4BF3U1622CB	G4BF3L1622CB	G4EFU3622CB	G4EFL3622CB
.016x.025	—	—	G4EFU1625CB	G4EFL1625CB	—	—	G4EFU3625CB	G4EFL3625CB
.017x.017	—	—	G4EFU1717CB	G4EFL1717CB	—	—	G4EFU3717CB	G4EFL3717CB
.017x.025	G4TFU1725CB	G4TFL1725CB	G4EFU1725CB	G4EFL1725CB	G4BF3U1725CB	G4BF3L1725CB	G4EFU3725CB	G4EFL3725CB
.018x.018	G4TFU1818CB	G4TFL1818CB	G4EFU1818CB	G4EFL1818CB	G4BF3U1818CB	G4BF3L1818CB	G4EFU3818CB	G4EFL3818CB
.018x.025	G4TFU1825CB	G4TFL1825CB	G4EFU1825CB	G4EFL1825CB	G4BF3U1825CB	G4BF3L1825CB	G4EFU3825CB	G4EFL3825CB
.019x.025	G4TFU1925CB	G4TFL1925CB	G4EFU1925CB	G4EFL1925CB	G4BF3U1925CB	G4BF3L1925CB	G4EFU3925CB	G4EFL3925CB
.020x.020	G4TFU2020CB	G4TFL2020CB	G4EFU2020CB	G4EFL2020CB	G4BF3U2020CB	G4BF3L2020CB	G4EFU3020CB	G4EFL3020CB

ORDER OPTIONS



Standard Pack

25 archwires/pack - order numbers as listed.



Optional Solo-Pack™

10 individually sealed autoclavable archwires per carton. For Solo-Pack™ wires, change "B" to "S" in part number. Please allow 2-3 days for Solo-Pack™ packaging.



Standard Pack
Tooth-Colored 10/pkg.

Tooth-Colored Pre-Stopped G4™ NiTi Archwires

Size	EUROPA [™] II	
	UPPER	LOWER
.014	G4EFU114CBT	G4EFL114CBT
.016	G4EFU116CBT	G4EFL116CBT
.018	G4EFU118CBT	G4EFL118CBT
.016x.027	G4EFU3627CBT	G4EFL3627CBT
.018x.025	G4EFU3825CBT	G4EFL3825CBT
.019x.025	G4EFU3925CBT	G4EFL3925CBT

*G&H® Orthodontics is in no way affiliated with or endorsed by Ormco Corporation or Dr. Dwight Damon. **MBT is a trademark of 3M Unitek.

°G&H® prescriptions are not implied to be an exact version of any other system, nor do we claim any endorsement by the doctor.

G4™ Pre-Torqued Nickel Titanium Archwires Precision Manufactured By G&H® Orthodontics



G4™ Pre-torqued NiTi wires provide early and continuous translation of torque forces to anteriors. Effective on upper or lower arches, there is 20° of torque built into the anterior region of each wire. Torque forces can be applied labially or lingually by reversing the orientation of the wire. Three anterior mm sizes allow torque forces to be applied to upper or lower arch with choice of 3 wire sizes.

- 20° Torque applied only to centrals and laterals
- Clinically proven G4™ recovery forces applied in the 3rd Order
- Roots torque and parallel consistently
- Begin torque translation early in treatment
- 2 popular archform choices - Trueform™ I and Europa™ II
- Pre-Torqued also available in Reverse Curve - see page 60

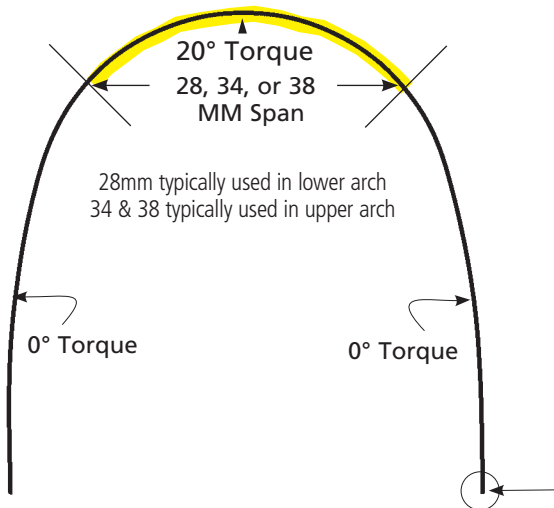

One end color coded:

- Red = 28mm (Lower)
- Blue = 34mm (Upper)
- Black = 38mm (Upper)

Color Mark Orientation:

- As applied to the upper arch - 34 & 38mm
- Engage color to patient right for lingual root torque
 - Engage color to patient left for labial root torque
 - Reverse this orientation for lower arch (28mm) applications

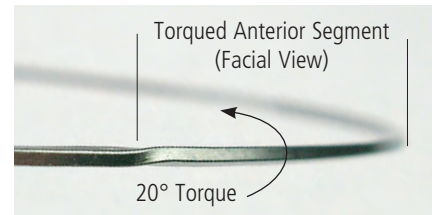

All G4™ Pre-Torqued NiTi wires available with or without pre-loaded crimpable stops

ORDER OPTIONS



Standard Pack

5 archwires/pack - order numbers as listed. For Crimpable Stops add "CB" to the end of the part number.



Optional Solo-Pack™

5 individually sealed autoclavable archwires per carton. For Solo-Pack™ wires, add "S" to the end of part number. For Solo-Pack™ plus Crimpable Stops, add "CS" Please allow 2-3 days for Solo-Pack™ packaging.

SIZE	ROTH™		DAMON®-COMPATIBLE		
	MBT™ SQUARE		EUROPA™ II		
	TRUEFORM™ I				
	mm span			mm span	
.017x.025	PTTF172528	28mm LOWER	PTEF372528	28mm	LOWER
	PTTF172534	34mm UPPER	PTEF372534	34mm	UPPER
	PTTF172538	38mm UPPER	PTEF372538	38mm	UPPER
.019x.025	PTTF192528	28mm LOWER	PTEF392528	28mm	LOWER
	PTTF192534	34mm UPPER	PTEF392534	34mm	UPPER
	PTTF192538	38mm UPPER	PTEF392538	38mm	UPPER
.021x.025	PTTF212528	28mm LOWER	-	-	-
	PTTF212534	34mm UPPER	-	-	-
	PTTF212538	38mm UPPER	-	-	-

Full-size archform shapes on page 49.

*G&H® Orthodontics is in no way affiliated with or endorsed by Ormco Corporation or Dr. Dwight Damon. **MBT is a trademark of 3M Unitek. °G&H® prescriptions are not implied to be an exact version of any other system, nor do we claim any endorsement by the doctor.

G4orce™ Progressive Force Nickel Titanium Archwires Precision Manufactured By G&H® Orthodontics



G4orce™ is a Triple Force G4™ NiTi wire with distinct zones offering progressive forces that increase from anterior to posterior. Light anterior force, medium cuspid/bicuspid force and heavy molar force.

“Individual tooth movement is optimized when applied force synchronizes with anatomy and periodontal physiology.”

- Small anterior teeth move best with lower forces
- Large posterior teeth move best with higher forces

G4orce™ is available in Trueform™ I archform

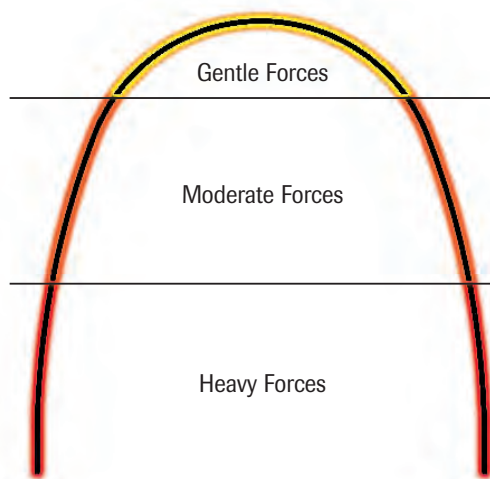
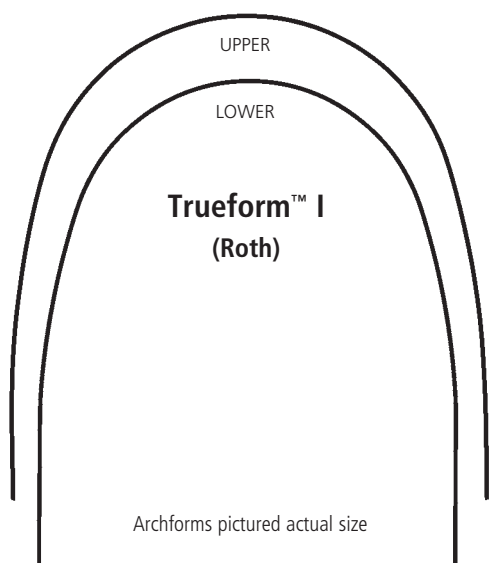

Three Forces in One Archwire for Optimum Control

Different force values applied to different arch segments*

- ▶ Anterior Teeth 100 grams
- ▶ Cuspid/Bicuspid 200 grams
- ▶ Molars 300 grams

*As applied to an .019x.025 wire

ORDER OPTIONS



Standard Pack

10 archwires/pack - order numbers as listed.



Optional Solo-Pack™

10 individually sealed autoclavable archwires per carton. For Solo-Pack™ wires, add “S” to the end of part number. Please allow 2-3 days for Solo-Pack™ packaging.

	ROTH ^{°°}	
	MBT ^{**} SQUARE	
	TRUEFORM™ I	
SIZE	UPPER	LOWER
.016	G4GFTU016	G4GFTL016
.018	G4GFTU018	G4GFTL018
.016x.016	G4GFTU1616	G4GFTL1616
.016x.022	G4GFTU1622	G4GFTL1622
.017x.025	G4GFTU1725	G4GFTL1725
.018x.018	G4GFTU1818	G4GFTL1818
.018x.025	G4GFTU1825	G4GFTL1825
.019x.025	G4GFTU1925	G4GFTL1925
.020x.020	G4GFTU2020	G4GFTL2020
.021x.025	G4GFTU2125	G4GFTL2125

[°]G&H® Orthodontics is in no way affiliated with or endorsed by Ormco Corporation or Dr. Dwight Damon. ^{**}MBT is a trademark of 3M Unitek.

^{°°}G&H® prescriptions are not implied to be an exact version of any other system, nor do we claim any endorsement by the doctor.

G4™ & M5™ Reverse Curve NiTi Archwires Precision Manufactured By G&H® Orthodontics



Manufactured in both G4™ and M5™ NiTi formats, Reverse Curve wires provide excellent counter forces to achieve bite modifications quickly and efficiently, while also improving archform integrity.

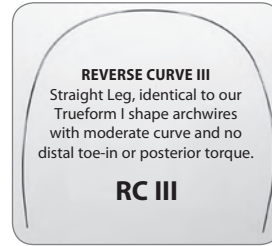
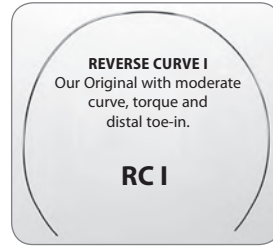

SIZE	Reverse Curve I				Reverse Curve III			
	G4™ NiTi		M5™ Thermal Copper NiTi		G4™ NiTi		M5™ Thermal Copper NiTi	
	UPPER	LOWER	UPPER	LOWER	UPPER	LOWER	UPPER	LOWER
.012	G4RCU012	G4RCL012	M5RCU012	M5RCL012	G4RCU3012	G4RCL3012	M5RCU3012	M5RCL3012
.014	G4RCU014	G4RCL014	M5RCU014	M5RCL014	G4RCU3014	G4RCL3014	M5RCU3014	M5RCL3014
.016	G4RCU016	G4RCL016	M5RCU016	M5RCL016	G4RCU3016	G4RCL3016	M5RCU3016	M5RCL3016
.018	G4RCU018	G4RCL018	M5RCU018	M5RCL018	G4RCU3018	G4RCL3018	M5RCU3018	M5RCL3018
.020	G4RCU020	G4RCL020	M5RCU020	M5RCL020	G4RCU3020	G4RCL3020	M5RCU3020	M5RCL3020
.016x.016	G4RCU1616	G4RCL1616	M5RCU1616	M5RCL1616	G4RCU31616	G4RCL31616	M5RCU31616	M5RCL31616
.016x.022	G4RCU1622	G4RCL1622	M5RCU1622	M5RCL1622	G4RCU31622	G4RCL31622	M5RCU31622	M5RCL31622
.017x.017	G4RCU1717	G4RCL1717	M5RCU1717	M5RCL1717	–	–	–	–
.017x.025	G4RCU1725	G4RCL1725	M5RCU1725	M5RCL1725	G4RCU31725	G4RCL31725	M5RCU31725	M5RCL31725
.018x.018	G4RCU1818	G4RCL1818	M5RCU1818	M5RCL1818	G4RCU31818	G4RCL31818	M5RCU31818	M5RCL31818
.018x.025	G4RCU1825	G4RCL1825	M5RCU1825	M5RCL1825	G4RCU31825	G4RCL31825	M5RCU31825	M5RCL31825
.019x.025	G4RCU1925	G4RCL1925	M5RCU1925	M5RCL1925	G4RCU31925	G4RCL31925	M5RCU31925	M5RCL31925
.020x.020	G4RCU2020	G4RCL2020	M5RCU2020	M5RCL2020	G4RCU32020	G4RCL32020	M5RCU32020	M5RCL32020
.021x.025	G4RCU2125	G4RCL2125	M5RCU2125	M5RCL2125	G4RCU32125	G4RCL32125	M5RCU32125	M5RCL32125

ORDER OPTIONS



Standard Pack

10 archwires/pack - order numbers as listed.
Optional: Dimpled Midline (narrow), - add "D" to the end of the part number.



Optional Solo-Pack™

10 individually sealed autoclavable archwires per carton.
For Solo-Pack™ wires, add "S" to the end of part number.
For Dimpled Midline (narrow), add "DS" to the end of part number.
Please allow 2-3 days for Solo-Pack™ packaging.



Europa™ II Reverse Curve is also available with preloaded crimpable stops

For pre-loaded Crimpable Stops add "CB" to the end of part number.
For Solo-Pack™ plus Crimpable Stops, add "CS"
Please allow 2-3 days for Solo-Pack™ packaging.

Damon®-Compatible		
Europa™ II Reverse Curve		
Size	UPPER	LOWER
.013	G4RCD113	–
.014	G4RCD114	–
.016	G4RCD116	–
.018	G4RCD118	–
.014x.025	G4RCD3425	G4RCM3425
.016x.016	G4RCD3616	–
.016x.025	G4RCD3625	–
.017x.017	G4RCD3717	–
.017x.025	G4RCD3725	–
.018x.018	G4RCD3818	–
.018x.025	G4RCD3825	G4RCM3825
.019x.025	G4RCD3925	–
.020x.020	G4RCD3020	–



*G&H® Orthodontics is in no way affiliated with or endorsed by Ormco Corporation or Dr. Dwight Damon. **MBT is a trademark of 3M Unitek.
*G&H® prescriptions are not implied to be an exact version of any other system, nor do we claim any endorsement by the doctor.

G4™ Pre-Torqued Reverse Curve NiTi Archwires Precision Manufactured By G&H® Orthodontics



Reverse Curve NiTi wires with 20° pre-torqued anterior segments increase torque control during intrusion. Lingual root torque is applied in upper archwires. Lower wires offer the choice of lingual or labial root torque.



Pre-Torqued Reverse Curve I

- Mild toe-in bends
- Our most popular

Pre-Torqued Europa™II Reverse Curve

- No toe-in bends
- Damon® compatible archform
- Available with or without pre-loaded crimpable stops

Pre-Torqued Reverse Curve I & Europa™II Reverse Curve Archform Notations

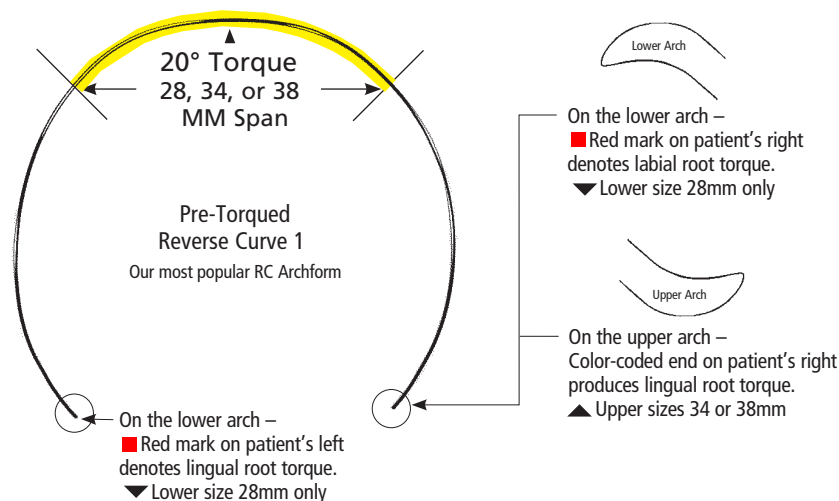

ORDER OPTIONS



Standard Pack

5 archwires/pack - order numbers as listed.



Optional Solo-Pack™

5 individually sealed autoclavable archwires per carton. For Solo-Pack™ wires, add "S" to the end of part number. Please allow 2-3 days for Solo-Pack™ packaging.

SIZE	REVERSE CURVE I				DAMON®-COMPATIBLE			
	mm span				mm span			
.017x.025	RC1B172528	28mm	LOWER	Labial Root Torque	RADB172528	28mm	LOWER	Labial Root Torque
	RC1G172528	28mm	LOWER	Lingual Root Torque	RCDG172528	28mm	LOWER	Lingual Root Torque
	RC1G172534	34mm	UPPER	Lingual Root Torque	RCDG172534	34mm	UPPER	Lingual Root Torque
	RC1G172538	38mm	UPPER	Lingual Root Torque	RCDG172538	38mm	UPPER	Lingual Root Torque
.019x.025	RC1B192528	28mm	LOWER	Labial Root Torque	RADB192528	28mm	LOWER	Labial Root Torque
	RC1G192528	28mm	LOWER	Lingual Root Torque	RCDG192528	28mm	LOWER	Lingual Root Torque
	RC1G192534	34mm	UPPER	Lingual Root Torque	RCDG192534	34mm	UPPER	Lingual Root Torque
	RC1G192538	38mm	UPPER	Lingual Root Torque	RCDG192538	38mm	UPPER	Lingual Root Torque

ARCHWIRE CUTTERS & PLIERS BEGIN ON PAGE 119

Europa™II Reverse Curve is also available with preloaded crimpable stops

For pre-loaded Crimpable Stops add "CB" to the end of part number. For Solo-Pack™ plus Crimpable Stops, add "CS"
Please allow 2-3 days for Solo-Pack™ packaging.

*G&H Orthodontics is in no way affiliated with or endorsed by Ormco Corporation or Dr. Dwight Damon

More choices in Nickel Titanium

FROM THE WORLD'S BEST MANUFACTURER OF PREMIUM ARCHWIRES

Compare our best selling G4™ NiTi and M5™ Thermal Copper NiTi!



G4™ Nickel Titanium

Nickel Titanium is a complex alloy to process and form. Very slight variations in a multitude of factors during manufacturing can alter its clinical performance. Only scientific testing of a NiTi wire can determine its actual working characteristics. Every G&H wire undergoes rigorous testing to ensure consistent clinical performance.

- Higher residual forces of recovery
- Full shape recovery
- Complete unraveling and archform development
- Stays active to the end – Moves teeth the last 1/2mm



M5™ Thermal Copper Nickel Titanium

M5™ Thermal Copper NiTi incorporates a precise temperature transformation of 27°C for predictable tooth moving forces. G&H quality manufacturing and testing processes make M5™ distinct from all other archwires used in orthodontics.

- Gentler loading forces for easier engagement and less patient trauma especially in severe cases
- Precise temperature transformation of 27°C
- Less susceptible to permanent deformation

See pages 55 (G4™) & 63 (M5™) for order numbers.

Comparative Hysteresis Graph
M5™ Thermal Copper NiTi & G4™ Nickel Titanium Archwires

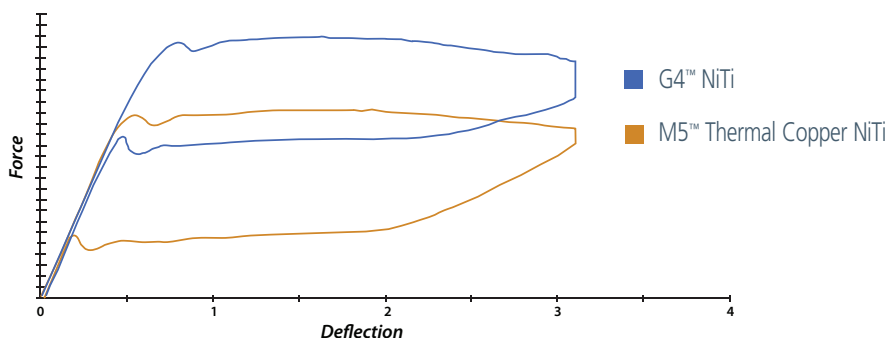

Tested to ANSI/ADA Specification #32, Orthodontic Wires: 2006

Experience the G&H difference –
Call 800-526-1026
or visit GHOrthodontics.com

See and order our full line of products at
GHOrthodontics.com



M5™ Thermal Copper Nickel Titanium Archwires Precision Manufactured By G&H® Orthodontics



M5™ Thermal Copper Nickel Titanium is a premium wire that incorporates a precise temperature transformation of 27°C for predictable tooth moving forces. G&H quality manufacturing and testing processes make M5™ Copper Nickel Titanium distinct from all other archwires used in orthodontics.

- Gentler loading forces for easier engagement
- Precise temperature transformation of 27°C
- Consistent and predictable tooth moving forces
- Proprietary mechanical high polish technique for reduced surface friction
- Available with or without preloaded crimpable stops
- US manufacturing quality

ALSO AVAILABLE On Pg.

- Lingual - 71
- Dimpled Midline (see below)
- Pre-Stopped (see below)

SIZE	ROTH [®]		Full-size archform shapes on page 49.					
	MBT ^{**} SQUARE		MBT ^{**} OVOID		MBT ^{**} TAPERED		DAMON [°] -COMPATIBLE	
	TRUEFORM™ I		EUROPA™ I		BIOFORM III		EUROPA™ II	
	UPPER	LOWER	UPPER	LOWER	UPPER	LOWER	UPPER	LOWER
.012	M5TFU012	M5TFL012	M5EFU012	M5EFL012	M5BF3U012	M5BF3L012	M5EFU112	M5EFL112
.014	M5TFU014	M5TFL014	M5EFU014	M5EFL014	M5BF3U014	M5BF3L014	M5EFU114	M5EFL114
.016	M5TFU016	M5TFL016	M5EFU016	M5EFL016	M5BF3U016	M5BF3L016	M5EFU116	M5EFL116
.018	M5TFU018	M5TFL018	M5EFU018	M5EFL018	M5BF3U018	M5BF3L018	M5EFU118	M5EFL118
.020	M5TFU020	M5TFL020	M5EFU020	M5EFL020	M5BF3U020	M5BF3L020	M5EFU120	M5EFL120
.014x.025	–	–	–	–	–	–	M5EFU3425	M5EFL3425
.016x.016	M5TFU1616	M5TFL1616	M5EFU1616	M5EFL1616	M5BF3U1616	M5BF3L1616	M5EFU3616	M5EFL3616
.016x.022	M5TFU1622	M5TFL1622	M5EFU1622	M5EFL1622	M5BF3U1622	M5BF3L1622	M5EFU3622	M5EFL3622
.016x.025	–	–	–	–	–	–	M5EFU3625	M5EFL3625
.017x.017	M5TFU1717	M5TFL1717	M5EFU1717	M5EFL1717	–	–	M5EFU3717	M5EFL3717
.017x.025	M5TFU1725	M5TFL1725	M5EFU1725	M5EFL1725	M5BF3U1725	M5BF3L1725	M5EFU3725	M5EFL3725
.018x.018	M5TFU1818	M5TFL1818	M5EFU1818	M5EFL1818	M5BF3U1818	M5BF3L1818	M5EFU3818	M5EFL3818
.018x.025	M5TFU1825	M5TFL1825	M5EFU1825	M5EFL1825	M5BF3U1825	M5BF3L1825	M5EFU3825	M5EFL3825
.019x.025	M5TFU1925	M5TFL1925	M5EFU1925	M5EFL1925	M5BF3U1925	M5BF3L1925	M5EFU3925	M5EFL3925
.020x.020	M5TFU2020	M5TFL2020	M5EFU2020	M5EFL2020	M5BF3U2020	M5BF3L2020	M5EFU3020	M5EFL3020
.021x.025	M5TFU2125	M5TFL2125	M5EFU2125	M5EFL2125	M5BF3U2125	M5BF3L2125	M5EFU3125	M5EFL3125

ORDER OPTIONS



Standard Pack

25 archwires/pack - order numbers as listed.



Optional Solo-Pack™

10 individually sealed autoclavable archwires per carton. For Solo-Pack™ wires, add "S" to the end of part number. Please allow 2-3 days for Solo-Pack™ packaging.

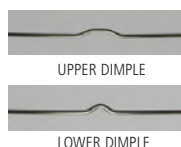

Optional Dimpled Midline

For Dimpled Midline wires, add "D" to the end of part number – for Dimpled Solo-Pack™ add "DS" to the end of part number.



Optional Pre-Stopped

For pre-loaded Crimpable Stops add "CB" to the end of part number. For Solo-Pack™ plus Crimpable Stops, add "CS"

°G&H® Orthodontics is in no way affiliated with or endorsed by Ormco Corporation or Dr. Dwight Damon. **MBT is a trademark of 3M Unitek.

°°G&H® prescriptions are not implied to be an exact version of any other system, nor do we claim any endorsement by the doctor.

From  World's Best Manufacturer of Premium Archwires

TitanMoly™

The Perfect Bendable, Nickel-Free Wire

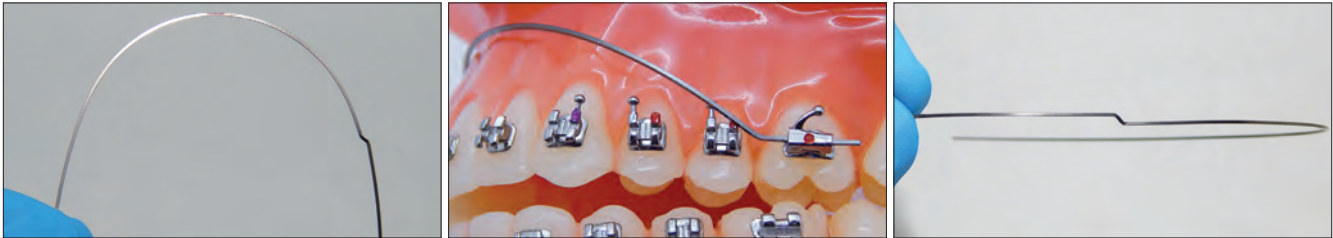

TitanMoly™ titanium molybdenum wire exhibits a superior working range for various treatment adaptations. All orders of treatment bends can be applied without breakage.

A **SMOOTHER** titanium molybdenum wire than the leading competitor

The material science behind G&H® titanium molybdenum archwires means:

- **Smoother surface finish for improved sliding mechanics:**
 - State-of-the-art diamond-drawing processes
 - Proprietary mechanical polishing technology, brighter finish
- **Precise tolerances for optimal torque expression**
- **Provides nearly twice the working range of stainless steel with 45% less deflection force and superior recovery**
- **Accepts adaptation bends without breakage**
- **Nickel-free for sensitive patients**
- **U.S. manufactured under stringent quality control**
- **Better value - direct from the manufacturer**



"The clinical advantage of titanium molybdenum archwires has been well documented. Now TitanMoly wires offer all the advantages plus reduced friction and a brighter, more pleasing finish."

– Howard A. Fine, DMD

G&H® TitanMoly™ is smoother

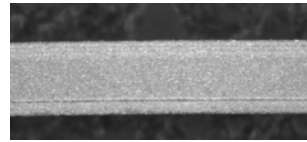

40x Magnification

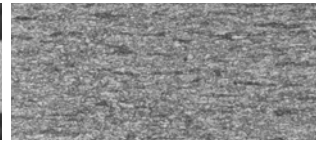

200x Magnification

Leading Competitor

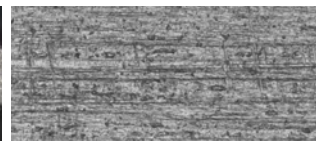
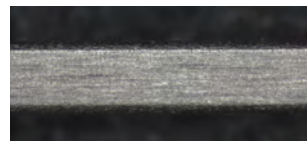

Independent Laboratory Surface Evaluation Testing Results:

G&H® titanium molybdenum wires are smoother as documented via optical light microscope and via a Zygo® 3D Surface Profiler per ASME B46.1.

Experience the G&H difference – Call 800-526-1026 or see and order our full line of products at

GHOrthodontics.com



ORTHODONTICS®

Quality Manufacturing. Exceptional Service.

Order our full line of products at GHOrthodontics.com or call 800-526-1026

TitanMoly™ Titanium Molybdenum Archwires Precision Manufactured By G&H® Orthodontics



TitanMoly™ titanium molybdenum archwires have enough recovery force and bendability without breaking, making them a preferred wire over stainless steel - and they are nickel-free.

TitanMoly™ titanium molybdenum wires provide force levels that are 45% less than those of equivalent stainless steel arches. TitanMoly™ represents the latest material science available in Titanium Molybdenum archwires.

ALSO AVAILABLE On Pg.

- Lingual - 71
- Straight Lengths - 75

- **Smoother surface finish for improved sliding mechanics:**
 - State-of-the-art diamond-drawing processes
 - Proprietary mechanical polishing technology, brighter finish
- **Precise tolerances for optimal torque expression**
- **Provides nearly twice the working range of stainless steel with 45% less deflection force and superior recovery**
- **Accepts adaptation bends without breakage**
- **Nickel-free for sensitive patients**
- **U.S. manufactured under stringent quality control**
- **Better value - direct from the manufacturer**

SIZE	ROTH [®]		Full-size archform shapes on page 49.					
	MBT ^{**} SQUARE		MBT ^{**} OVOID		MBT ^{**} TAPERED		DAMON [°] -COMPATIBLE	
	TRUEFORM™ I		EUROPA™ I		BIOFORM III		EUROPA™ II	
	UPPER	LOWER	UPPER	LOWER	UPPER	LOWER	UPPER	LOWER
.016	B3TFU016	B3TFL016	–	–	–	–	–	–
.018	B3TFU018	B3TFL018	–	–	–	–	–	–
.016x.016	B3TFU1616	B3TFL1616	–	–	–	–	–	–
.016x.022	B3TFU1622	B3TFL1622	B3EFU1622	B3EFL1622	B3BF3U1622	B3BF3L1622	B3EFU3622	B3EFL3622
.017x.025	B3TFU1725	B3TFL1725	B3EFU1725	B3EFL1725	B3BF3U1725	B3BF3L1725	B3EFU3725	B3EFL3725
.0175x.0175	B3TFU7575	B3TFL7575	–	–	–	–	–	–
.018x.025	B3TFU1825	B3TFL1825	–	–	–	–	–	–
.019x.025	B3TFU1925	B3TFL1925	B3EFU1925	B3EFL1925	B3BF3U1925	B3BF3L1925	B3EFU3925	B3EFL3925
.020x.020	–	–	–	–	–	–	B3EFU3020	B3EFL3020
.021x.025	B3TFU2125	B3TFL2125	–	–	–	–	B3EFU3125	B3EFL3125

Additional archform shapes available for this wire on page 79.

ORDER OPTIONS



Standard Pack

10 archwires/pack - order numbers as listed



Solo-Pack™

10 individually sealed autoclavable archwires per carton.
For Solo-Pack™ wires, add "S" to the end of part number.
Please allow 2-3 days for Solo-Pack™ packaging.

TitanMoly™ archwires are also available with retraction loops - see our website for more details, GHOrthodontics.com.

ARCHWIRE CUTTERS
& PLIERS BEGIN
ON PAGE 119

[°]G&H® Orthodontics is in no way affiliated with or endorsed by Ormco Corporation or Dr. Dwight Damon. ^{**}MBT is a trademark of 3M Unitek.

^{°°}G&H® prescriptions are not implied to be an exact version of any other system, nor do we claim any endorsement by the doctor.

S3™ Stainless Steel Archwires Precision Manufactured By G&H® Orthodontics



G&H® uses only 304V medical grade stainless steel wire in forming these archwires. G&H® uses state-of-the-art forming equipment which ensures product integrity, consistent performance characteristics, and precise archforms.

ALSO AVAILABLE On Pg.

- Tooth-Colored - 67
- Heat-Treated - 68
- Looped - 69
- Posted - 70
- Lingual - 71
- Multi-Strand - 74

SIZE	ROTH [®]		Full-size archform shapes on page 49.					
	MBT ^{**} SQUARE		MBT ^{**} OVOID		MBT ^{**} TAPERED		DAMON [°] -COMPATIBLE	
	TRUEFORM™ I		EUROPA™ I		BIOFORM III		EUROPA™ II	
	UPPER	LOWER	UPPER	LOWER	UPPER	LOWER	UPPER	LOWER
.012	S3TFU012	S3TFL012	S3EFU012	S3EFL012	S3BF3U012	S3BF3L012	S3EFU112	S3EFL112
.014	S3TFU014	S3TFL014	S3EFU014	S3EFL014	S3BF3U014	S3BF3L014	S3EFU114	S3EFL114
.016	S3TFU016	S3TFL016	S3EFU016	S3EFL016	S3BF3U016	S3BF3L016	S3EFU116	S3EFL116
.018	S3TFU018	S3TFL018	S3EFU018	S3EFL018	S3BF3U018	S3BF3L018	S3EFU118	S3EFL118
.020	S3TFU020	S3TFL020	S3EFU020	S3EFL020	S3BF3U020	S3BF3L020	S3EFU120	S3EFL120
.016x.016	S3TFU1616	S3TFL1616	S3EFU1616	S3EFL1616	S3BF3U1616	S3BF3L1616	S3EFU3616	S3EFL3616
.016x.022	S3TFU1622	S3TFL1622	S3EFU1622	S3EFL1622	S3BF3U1622	S3BF3L1622	S3EFU3622	S3EFL3622
.016x.025	S3TFU1625	–	S3EFU1625	S3EFL1625	–	–	S3EFU3625	S3EFL3625
.017x.017	S3TFU1717	S3TFL1717	S3EFU1717	S3EFL1717	S3BF3U1717	S3BF3L1717	S3EFU3717	S3EFL3717
.017x.022	S3TFU1722	S3TFL1722	S3EFU1722	S3EFL1722	S3BF3U1722	S3BF3L1722	S3EFU3722	S3EFL3722
.017x.025	S3TFU1725	S3TFL1725	S3EFU1725	S3EFL1725	S3BF3U1725	S3BF3L1725	S3EFU3725	S3EFL3725
.018x.018	S3TFU1818	S3TFL1818	S3EFU1818	S3EFL1818	S3BF3U1818	S3BF3L1818	S3EFU3818	S3EFL3818
.018x.022	S3TFU1822	S3TFL1822	S3EFU1822	S3EFL1822	S3BF3U1822	S3BF3L1822	S3EFU3822	S3EFL3822
.018x.025	S3TFU1825	S3TFL1825	S3EFU1825	S3EFL1825	S3BF3U1825	S3BF3L1825	S3EFU3825	S3EFL3825
.019x.019	S3TFU1919	S3TFL1919	S3EFU1919	S3EFL1919	S3BF3U1919	S3BF3L1919	S3EFU3919	S3EFL3919
.019x.025	S3TFU1925	S3TFL1925	S3EFU1925	S3EFL1925	S3BF3U1925	S3BF3L1925	S3EFU3925	S3EFL3925
.020x.020	S3TFU2020	S3TFL2020	S3EFU2020	S3EFL2020	S3BF3U2020	S3BF3L2020	S3EFU3020	S3EFL3020
.021x.025	S3TFU2125	S3TFL2125	S3EFU2125	S3EFL2125	S3BF3U2125	S3BF3L2125	S3EFU3125	S3EFL3125

ORDER OPTIONS

Additional archform shapes available for this wire on page 79.



Standard Pack

25 archwires/pack - order numbers as listed.



Solo-Pack™

10 individually sealed autoclavable archwires per carton. For Solo-Pack™ wires, add "S" to the end of part number. Please allow 2-3 days for Solo-Pack™ packaging.

ARCHWIRE BENDING
PLIERS AVAILABLE
ON PAGE 119

°G&H® Orthodontics is in no way affiliated with or endorsed by Ormco Corporation or Dr. Dwight Damon. **MBT is a trademark of 3M Unitek. °°G&H® prescriptions are not implied to be an exact version of any other system, nor do we claim any endorsement by the doctor.

S3™ Tooth-Colored Stainless Steel Archwires Precision Manufactured By G&H® Orthodontics

The only epoxy coated wires in orthodontics.



304V stainless steel tooth-colored epoxy coated archwires necessitate the use of base wires that are .002" smaller than the final coated dimensions, so please consider this when selecting wires to ensure performance will be compatible with treatment objectives.

- Durable epoxy coating
- Stain resistant
- Midline marked



Tooth-colored archwires are ink midlined (black upper - red lower) for symmetrical identification. After archwire placement, rub midline gently with a cotton swab dipped in isopropyl alcohol—this will remove the majority of ink.

SIZE	ROTH [®]		Full-size archform shapes on page 49.					
	MBT ^{**} SQUARE		MBT ^{**} OVOID		MBT ^{**} TAPERED		DAMON [°] -COMPATIBLE	
	TRUEFORM™ I		EUROPA™ I		BIOFORM III		EUROPA™ II	
	UPPER	LOWER	UPPER	LOWER	UPPER	LOWER	UPPER	LOWER
.014	S3TFU014T	S3TFL014T	S3EFU014T	S3EFL014T	S3BF3U014T	S3BF3L014T	S3EFU114T	S3EFL114T
.016	S3TFU016T	S3TFL016T	S3EFU016T	S3EFL016T	S3BF3U016T	S3BF3L016T	S3EFU116T	S3EFL116T
.018	S3TFU018T	S3TFL018T	S3EFU018T	S3EFL018T	S3BF3U018T	S3BF3L018T	S3EFU118T	S3EFL118T
.020	S3TFU020T	S3TFL020T	S3EFU020T	S3EFL020T	S3BF3U020T	S3BF3L020T	S3EFU120T	S3EFL120T
.016x.022	S3TFU1622T	S3TFL1622T	S3EFU1622T	S3EFL1622T	S3BF3U1622T	S3BF3L1622T	S3EFU3622T	S3EFL3622T
.017x.025	S3TFU1725T	S3TFL1725T	S3EFU1725T	S3EFL1725T	S3BF3U1725T	S3BF3L1725T	S3EFU3725T	S3EFL3725T
.018x.018	S3TFU1818T	S3TFL1818T	S3EFU1818T	S3EFL1818T	S3BF3U1818T	S3BF3L1818T	S3EFU3818T	S3EFL3818T
.018x.025	S3TFU1825T	S3TFL1825T	S3EFU1825T	S3EFL1825T	S3BF3U1825T	S3BF3L1825T	S3EFU3825T	S3EFL3825T
.019x.025	S3TFU1925T	S3TFL1925T	S3EFU1925T	S3EFL1925T	S3BF3U1925T	S3BF3L1925T	S3EFU3925T	S3EFL3925T
.020x.020	S3TFU2020T	S3TFL2020T	S3EFU2020T	S3EFL2020T	S3BF3U2020T	S3BF3L2020T	S3EFU3020T	S3EFL3020T
.021x.025	S3TFU2125T	S3TFL2125T	S3EFU2125T	S3EFL2125T	S3BF3U2125T	S3BF3L2125T	S3EFU3125T	S3EFL3125T

ORDER OPTIONS



Standard Pack

25 archwires/pack - order numbers as listed.



Solo-Pack™

10 individually sealed autoclavable archwires per carton. For Solo-Pack™ wires, add "S" to the end of part number. Please allow 2-3 days for Solo-Pack™ packaging.

ARCHWIRE CUTTERS
& PLIERS BEGIN
ON PAGE 119

[°]G&H® Orthodontics is in no way affiliated with or endorsed by Ormco Corporation or Dr. Dwight Damon. ^{**}MBT is a trademark of 3M Unitek.
^{°°}G&H® prescriptions are not implied to be an exact version of any other system, nor do we claim any endorsement by the doctor.

XR1™ Heat-Treated Stainless Steel Archwires Precision Manufactured By G&H® Orthodontics



Our new XR1™ Stainless Steel is uniquely heat-treated and stress-relieved – increasing the resiliency of the wire to improve mechanics. G&H® uses state of the art forming equipment which ensures product integrity, consistent performance characteristics and precise archforms. With over 40 years of wire forming experience, G&H® understands the intricacies and nature of archwire production and takes great pride in craftsmanship.



SIZE	ROTH ^{°°}		Full-size archform shapes on page 49.					
	MBT ^{**} SQUARE		MBT ^{**} OVOID		MBT ^{**} TAPERED		DAMON [°] -COMPATIBLE	
	TRUEFORM™ I		EUROPA™ I		BIOFORM III		EUROPA™ II	
	UPPER	LOWER	UPPER	LOWER	UPPER	LOWER	UPPER	LOWER
.012	XRTFU012	XRTFL012	XREFU012	XREFL012	XRBF3U012	XRBF3L012	XREFU112	XREFL112
.014	XRTFU014	XRTFL014	XREFU014	XREFL014	XRBF3U014	XRBF3L014	XREFU114	XREFL114
.016	XRTFU016	XRTFL016	XREFU016	XREFL016	XRBF3U016	XRBF3L016	XREFU116	XREFL116
.018	XRTFU018	XRTFL018	XREFU018	XREFL018	XRBF3U018	XRBF3L018	XREFU118	XREFL118
.020	XRTFU020	XRTFL020	XREFU020	XREFL020	XRBF3U020	XRBF3L020	XREFU120	XREFL120
.016x.016	XRTFU1616	XRTFL1616	XREFU1616	XREFL1616	XRBF3U1616	XRBF3L1616	XREFU3616	XREFL3616
.016x.022	XRTFU1622	XRTFL1622	XREFU1622	XREFL1622	XRBF3U1622	XRBF3L1622	XREFU3622	XREFL3622
.016x.025	–	–	XREFU1625	XREFL1625	–	–	XREFU3625	XREFL3625
.017x.017	XRTFU1717	XRTFL1717	XREFU1717	XREFL1717	XRBF3U1717	XRBF3L1717	XREFU3717	XREFL3717
.017x.022	XRTFU1722	XRTFL1722	XREFU1722	XREFL1722	XRBF3U1722	XRBF3L1722	XREFU3722	XREFL3722
.017x.025	XRTFU1725	XRTFL1725	XREFU1725	XREFL1725	XRBF3U1725	XRBF3L1725	XREFU3725	XREFL3725
.018x.018	XRTFU1818	XRTFL1818	XREFU1818	XREFL1818	XRBF3U1818	XRBF3L1818	XREFU3818	XREFL3818
.018x.022	XRTFU1822	XRTFL1822	XREFU1822	XREFL1822	XRBF3U1822	XRBF3L1822	XREFU3822	XREFL3822
.018x.025	XRTFU1825	XRTFL1825	XREFU1825	XREFL1825	XRBF3U1825	XRBF3L1825	XREFU3825	XREFL3825
.019x.025	XRTFU1925	XRTFL1925	XREFU1925	XREFL1925	XRBF3U1925	XRBF3L1925	XREFU3925	XREFL3925
.020x.020	XRTFU2020	XRTFL2020	XREFU2020	XREFL2020	XRBF3U2020	XRBF3L2020	XREFU3020	XREFL3020
.021x.025	XRTFU2125	XRTFL2125	XREFU2125	XREFL2125	XRBF3U2125	XRBF3L2125	XREFU3125	XREFL3125

ORDER OPTIONS



Standard Pack

25 archwires/pack - order numbers as listed.



Solo-Pack™

10 individually sealed autoclavable archwires per carton. For Solo-Pack™ wires, add "S" to the end of part number. Please allow 2-3 days for Solo-Pack™ packaging.

Additional archform shapes available for this wire on page 79.

ARCHWIRE CUTTERS & PLIERS BEGIN ON PAGE 119

[°]G&H® Orthodontics is in no way affiliated with or endorsed by Ormco Corporation or Dr. Dwight Damon. ^{**}MBT is a trademark of 3M Unitek. ^{°°}G&H® prescriptions are not implied to be an exact version of any other system, nor do we claim any endorsement by the doctor.

Stainless Steel Looped Archwires Precision Manufactured By G&H® Orthodontics



G&H's looped retraction arches are individually formed to exacting standards. Our looped archwires are available in Keyhole Loops and T-Loops allowing clinicians a choice of designs. These loops make a stainless archwire a multipurpose treatment adjunct that can achieve various intraoral objectives, often simultaneously. Such objectives can include:

- Friction-free segmented retraction
- Opening or closing spaces
- Intruding or extruding anterior teeth
- Opening or closing the bite
- Leveling the Curve of Spee
- Engaging Class I, II, III or up-and-down elastics
- Torquing the anterior or posterior teeth
- Attaching J-hooks for headgear in retracting anterior teeth

Looped sizes 28mm (Lower) & 36mm (Upper) are used the most.



KEYHOLE

T-LOOP

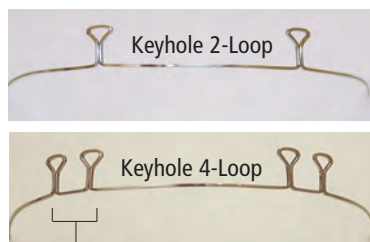

Paired Loop Spacing – 6.5mm Lower, 8mm Upper

ORDER OPTIONS



Standard Pack
10 archwires/pack - order numbers as listed.

Looped Archwire Kit of 100 wires size distribution

MM Sizes	22	24	26	28	30	32	34	36	38	40	42	44	46
Keyhole (quantity per size)	5	5	10	10	10	5	10	10	10	10	10	5	N/A
T-Loop (quantity per size)	N/A	5	10	10	10	5	5	10	10	10	10	10	5

(Solo-Pack™ not available for looped and posted wires.)

KEYHOLE

ROTH^{°°}

MBT^{**} SQUARE

TRUEFORM™ I

SIZE	2-LOOP	4-LOOP
.016x.022	KHTF21622*	KHTF41622*
.017x.025	KHTF21725*	KHTF41725*
.019x.025	KHTF21925*	KHTF41925*
KITS	KHTFK2**	KHTFK4**

*Insert preferred millimeter size, available in 2mm increments - Upper = 34mm to 44mm / Lower = 22mm to 32mm.

**Insert preferred wire size - Kit includes 100 wires plus dispenser and ruler.

Note: .016x.016, .016x.022, .017x.025, .018x.025, .019x.025 - Trueform • 2-Loop - Kits not available .016x.022, .017x.025 & .019x.025 - Trueform • 4-Loop - Kits not available

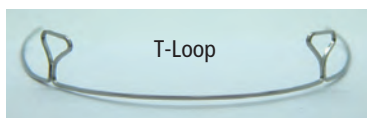

T-Loop

Also available in TitanMoly™ titanium molybdenum (See our website)

Dr. Ron Roth said that for retraction, a stainless loop should be activated by expanding it the "width of one thin dime."

ORDER OPTIONS



Standard Pack
10 archwires/pack - order numbers as listed.

T-LOOP

ROTH^{°°}

MBT^{**} SQUARE

TRUEFORM™ I

SIZE	2-LOOP
.016x.022	TLTF1622*
.017x.025	TLTF1725*
.019x.025	TLTF1925*
KITS	TLTFK**

*Insert preferred millimeter size, available in 2mm increments - Upper = 36mm to 46mm / Lower = 24mm to 34mm.

**Insert preferred wire size - Kit includes 100 wires plus dispenser and ruler.

Companion Product



MM Ruler
Our unique double-sided ruler features a hole to engage a post or hook making space measurement quick, easy and accurate. 20/Box
60mm Ruler RULERMG
80mm Ruler RULERMGG

Tech Tip for Looped & Posted Wires:

To apply anterior torque, hold the loop or post by straddling it with a Rose Torquing Plier. Apply 3rd order bends with a second plier to the anterior segment without distorting the loop or post.

°G&H® Orthodontics is in no way affiliated with or endorsed by Ormco Corporation or Dr. Dwight Damon. **MBT is a trademark of 3M Unitek.

°°G&H® prescriptions are not implied to be an exact version of any other system, nor do we claim any endorsement by the doctor.

XR1™ Ball Post Archwires Precision Manufactured By G&H® Orthodontics



Our exclusive XR1™ Ball Post archwires offer the comfort and retention of ball ends plus a bendable brass post. A G&H® proprietary soldering technique ensures clean, strong and consistent joints.

The .016x.022, .016x.025 or .019x.025 XR1™ stainless base wire is heat-treated and stress relieved – increasing the resiliency of the wire to improve mechanics.

Archforms available are Damon®-compatible, MBT Ovoid, MBT Tapered, or Trueform™.

Brass Ball-End Posts Provide

- Patient Comfort
- Maximum Retention
- Adaptability

Proprietary Solder Technique

- Strong, Secure & Smooth Joints
- No Archwire Annealing

XR1™ Heat-Treated Stainless Base Wire

- Increased Resiliency
- Minimizes Distortion

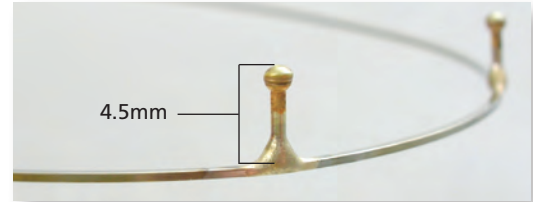

ORDER OPTIONS



Standard Pack

10 archwires/pack - order numbers as listed.

SIZE	ROTH™	DAMON® COMPATIBLE		
	MBT™ SQUARE	MBT™ OVOID	MBT™ TAPERED	
.016x.022	TRUEFORM™ I PXBT1622*	EUROPA™ I –	BIOFORM III PXBB31622*	EUROPA™ II –
.017x.025	–	PXBE1725*	PXBB31725*	–
.019x.025	PXBT1925*	PXBE1925*	PXBB31925*	PXBD3925*

*Insert preferred millimeter size, available in 2mm increments - 22mm to 44mm.

Ball Post Kits				
.016x.022	PXBT1622	–	PXBB3K1622	–
.017x.025	–	PXBEK1725	PXBB3K1725	–
.019x.025	PXBT1925	PXBEK1925	PXBB3K1925	PXBDK3925

Kit includes 100 wires plus dispenser and ruler.

Posted Archwire Kit of 100 wires size distribution - Straight Post and Ball Post Kits

MM Sizes	22	24	26	28	30	32	34	36	38	40	42	44	46
Posted (quantity per size)	5	5	10	10	10	5	10	10	10	10	10	5	N/A

(Solo-Pack™ not available for looped and posted wires.)

Straight Post Archwires

Our straight post & ball end post stainless steel posted arches have .030" silver soldered brass posts.

Sized in 2mm increments, upper archwires are available in 34 to 44 mm sizes, lower in 22 to 32mm.

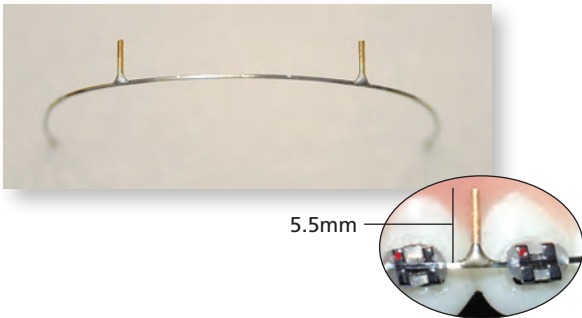

SIZE	ROTH™	DAMON® COMPATIBLE	
	MBT™ SQUARE	MBT™ OVOID	MBT™ TAPERED
.016	PSTF016*	PSEF016*	–
.018	PSTF018*	PSEF018*	–
.020	PSTF020*	PSEF020*	–
.016x.016	PSTF1616*	PSEF1616*	–
.016x.022	PSTF1622*	PSEF1622*	–
.016x.025	–	–	PSEF3625*
.017x.025	PSTF1725*	PSEF1725*	PSEF3725*
.018x.025	PSTF1825*	PSEF1825*	–
.019x.025	PSTF1925*	PSEF1925*	PSEF3925*
.020x.020	PSTF2020*	PSEF2020*	–
.021x.025	PSTF2125*	PSEF2125*	PSEF3125*

*Insert preferred millimeter size, available in 2mm increments - 22mm to 44mm.

Straight Post Kits

	PSTFK**	PSEFK**	.016x.025	PSEFK3625
Trueform™ I and Europa™ I kits are available in all sizes listed above - insert preferred wire size.			.017x.025	PSEFK3725
			.019x.025	PSEFK3925*
	Europa™ II kits are available in sizes listed at right.		.021x.025	PSEFK3125

Kit includes 100 wires plus dispenser and ruler.

©G&H® Orthodontics is in no way affiliated with or endorsed by Ormco Corporation or Dr. Dwight Damon.

**MBT is a trademark of 3M Unitek.

©G&H® prescriptions are not implied to be an exact version of any other system, nor do we claim any endorsement by the doctor.

Lingual Archwires - Preformed Precision Manufactured By G&H® Orthodontics

G&H® also offers a comprehensive line of Lingual Archwires developed to meet the challenging mechanics of modern lingual treatment. Archforms are designed and adapted precisely to lingual anatomy. Various alloys are offered to maximize treatment efficiencies in the narrow interbracket dimensions of lingual orthodontic treatment.

Nickel Titanium lingual wires are available in .010, .013, .016 G4™ NiTi for early engagement. M5™ (Thermal) NiTi wires in .016, .016x.022, .017x.017 or .017x.025 allow transitional sequencing. G4™ and M5™ Lingual Wires are produced in the popular "mushroom" shape lingual archform. Three anterior sizes in both uppers and lowers ensure a proper fit.

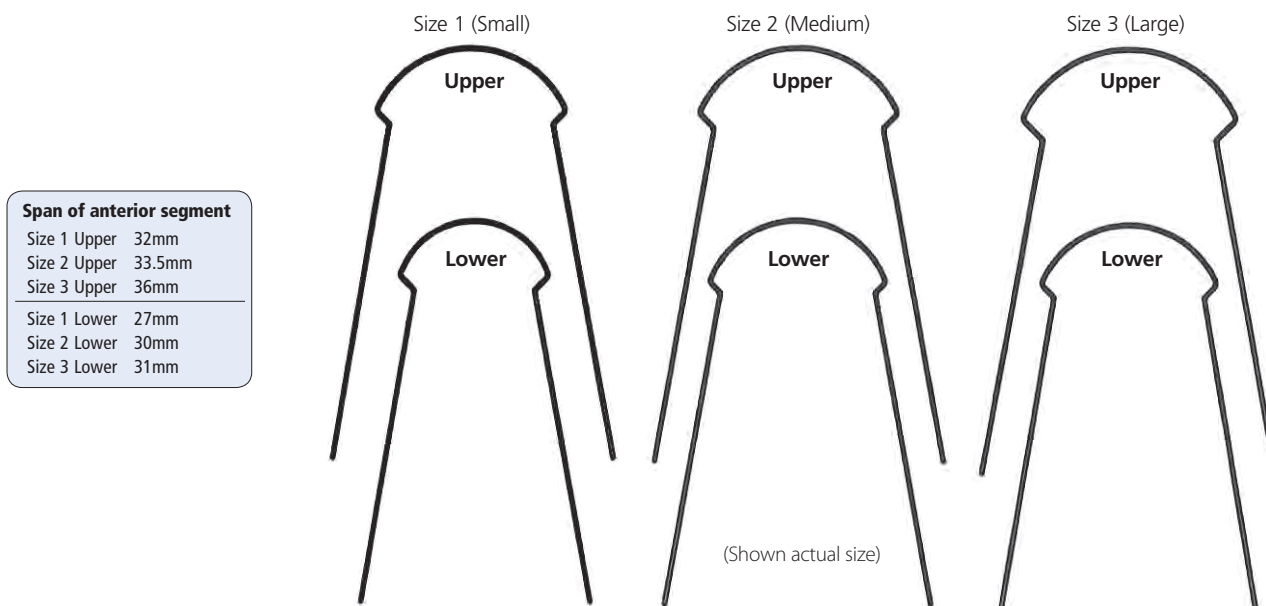

ORDER OPTIONS



Standard Pack

2 archwires/pack - order numbers as listed.



Optional Solo-Pack™

2 individually sealed autoclavable archwires per carton. For Solo-Pack™ wires, add "S" to the end of part number.

Please allow 2-3 days for Solo-Pack™ packaging.

G4™ NiTi Lingual Arches

SIZE	
.010 Small (1) Upper	G4LSU010
.010 Small (1) Lower	G4LSL010
.010 Medium (2) Upper	G4LMU010
.010 Medium (2) Lower	G4LML010
.010 Large (3) Upper	G4LLU010
.010 Large (3) Lower	G4LLL010
.013 Small (1) Upper	G4LSU013
.013 Small (1) Lower	G4LSL013
.013 Medium (2) Upper	G4LMU013
.013 Medium (2) Lower	G4LML013
.013 Large (3) Upper	G4LLU013
.013 Large (3) Lower	G4LLL013
.016 Small (1) Upper	G4LSU016
.016 Small (1) Lower	G4LSL016
.016 Medium (2) Upper	G4LMU016
.016 Medium (2) Lower	G4LML016
.016 Large (3) Upper	G4LLU016
.016 Large (3) Lower	G4LLL016

M5™ NiTi Lingual Arches

SIZE	
.016 Small (1) Upper	M5LSU016
.016 Small (1) Lower	M5LSL016
.016 Medium (2) Upper	M5LMU016
.016 Medium (2) Lower	M5LML016
.016 Large (3) Upper	M5LLU016
.016 Large (3) Lower	M5LLL016
.016x.022 Small (1) Upper	M5LSU1622
.016x.022 Small (1) Lower	M5LSL1622
.016x.022 Medium (2) Upper	M5LMU1622
.016x.022 Medium (2) Lower	M5LML1622
.016x.022 Large (3) Upper	M5LLU1622
.016x.022 Large (3) Lower	M5LLL1622
.017x.017 Small (1) Upper	M5LSU1717
.017x.017 Small (1) Lower	M5LSL1717
.017x.017 Medium (2) Upper	M5LMU1717
.017x.017 Medium (2) Lower	M5LML1717
.017x.017 Large (3) Upper	M5LLU1717
.017x.017 Large (3) Lower	M5LLL1717
.017x.025 Small (1) Upper	M5LSU1725
.017x.025 Small (1) Lower	M5LSL1725
.017x.025 Medium (2) Upper	M5LMU1725
.017x.025 Medium (2) Lower	M5LML1725
.017x.025 Large (3) Upper	M5LLU1725
.017x.025 Large (3) Lower	M5LLL1725

Lingual Archwires - Universal Precision Manufactured By G&H® Orthodontics

G&H® universal lingual archwires (Small - Ex-Large) are formed in G4™ nickel titanium and TitanMoly™ titanium molybdenum. Universal archforms allow the clinician to apply the offset bends to adapt precisely to lingual anatomy.

NiTi and titanium molybdenum maximize treatment efficiencies in the narrow interbracket dimensions of lingual orthodontic treatment.

G4™ NiTi Universal Lingual Arches

SIZE	Small	Medium	Large	Ex-Large
.010	G4SLUN010	G4MLUN010	G4LLUN010	G4XLUN010
.012	G4SLUN012	G4MLUN012	G4LLUN012	G4XLUN012
.014	G4SLUN014	G4MLUN014	G4LLUN014	G4XLUN014
.016	G4SLUN016	G4MLUN016	G4LLUN016	G4XLUN016
.016x.022	-	-	-	G4XLUN1622
.017x.017	-	-	-	G4XLUN1717

TitanMoly™ Titanium Molybdenum Universal Lingual Arches

SIZE	Small	Medium	Large	Ex-Large
.016	B3SLUN016	B3MLUN016	B3LLUN016	B3XLUN016
.0175x.0175	B3SLUN17175	B3MLUN17175	B3LLUN17175	B3XLUN17175

ORDER OPTIONS



Standard Pack

5 archwires/pack - order numbers as listed.



Optional Solo-Pack™

5 individually sealed autoclavable archwires per carton. For Solo-Pack™ wires, add "S" to the end of part number. Please allow 2-3 days for Solo-Pack™ packaging.

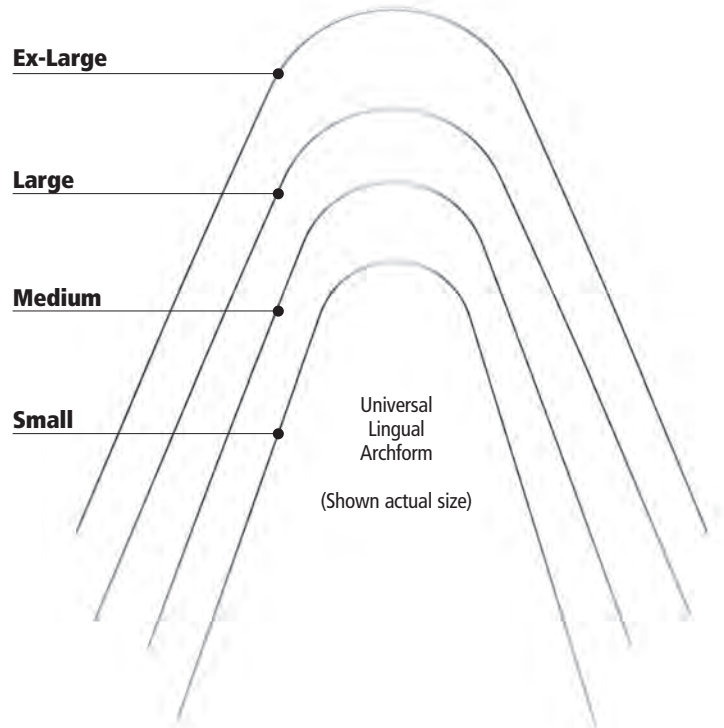

Additional (Single Shape) Universal Lingual Archwires

S3™ Stainless Steel Universal Lingual Arches

SIZE	Universal
.014	S3L014
.016	S3L016
.018	S3L018
.016x.022	S3L1622

TitanMoly™ Titanium Molybdenum Universal Lingual Arches

SIZE	Universal
.016	B3L016
.016x.022	B3L1622
.0175x.0175	B3L175175

ORDER OPTIONS



Standard Pack

5 archwires/pack - order numbers as listed.



Optional Solo-Pack™

5 individually sealed autoclavable archwires per carton. For Solo-Pack™ wires, add "S" to the end of part number. Please allow 2-3 days for Solo-Pack™ packaging.

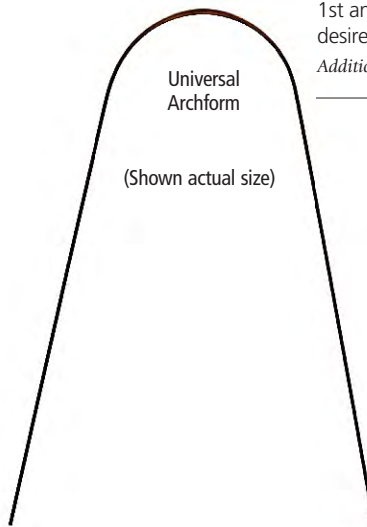

NiTi Cinch-Back Plier

The NiTi cinch-back plier is designed to place permanent offset bends in nickel titanium archwires. The unique design provides access for cinch-back bends to wires distal to the buccal tubes on either side of the arch. 1st and 2nd order bends can also be made as desired anywhere on the archwire. **GH047**

Additional pliers begin on page 119.





A.J. Wilcock® Australian Combination Lingual Archwire

A.J. Wilcock® lingual combination archwires are rectangular in the anterior segment to maintain torque while the round posterior segments allow sliding mechanics with reduced friction.

Combination Lingual Archwires

SIZE

Anterior	Posterior	
.016x.022	.016	AW671-622*
.017x.025	.017	AW671-725*
.019x.025	.019	AW671-925*
.021x.025	.021	AW672-125*

*Insert millimeter span of anterior segment 26 - 38 in 2 mm increments.

A.J. Wilcock® combination wires are not available in Solo-Pack™ packaging.

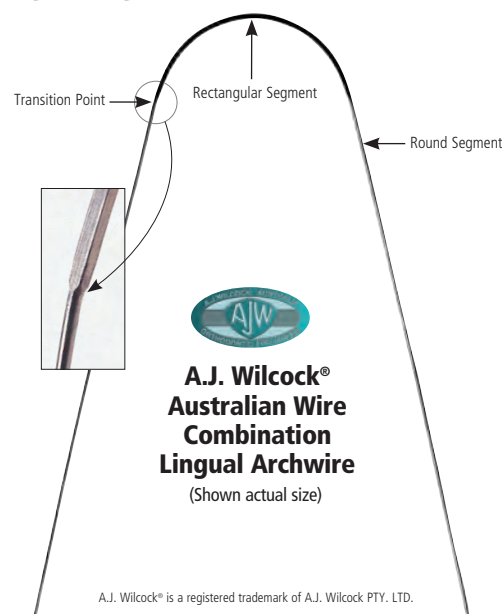

Bonded Lingual Retainers

Wires of various alloys and dimensions are frequently used clinically to fabricate bonded lingual retainers. Below are some of the favorite choices of contemporary orthodontists.

Multi-Strand Wire

The most popular wire for bonded lingual retainers, .0175 – 7-Strand (Twisted) stainless steel wire, available in 14" straight lengths or 30" spools.

See complete product details on page 74.



Bond-A-Braid

Hilgers Bond-A-Braid

The dead-soft wire easily adapts and is excellent for semi-permanent orthodontic retention.

See complete product details on page 105.



Fiber Reinforced Composites

• everStick® Ortho

See complete product details on page 113.

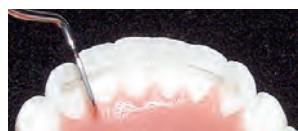

Ortho-FlexTech™

Ortho-FlexTech™

The next generation in lingual retention: using solid gold or stainless steel chain retainer.

See complete product details on page 105.



Adhesives

Flowtain®

Flowtain is a flowable light cured composite with low viscosity which makes it ideal for bonded lingual retainers and splints.

See complete product details on page 102.



LCR® Adhesive

LCR® is a light cure retainer adhesive.

See complete product details on page 102.



Retanium™

Single strand nickel-free titanium flat metal ribbon is ideal for semi-permanent splinting and maintaining difficult extraction sites.

See complete product details on page 105.



Wire Bonder/ Mini-Mold

Each mold is designed to pack with light cure adhesive, press against tooth, cure and peel away mold leaving a formed auxiliary on any tooth in just minutes.

See complete product details on page 112.



Multi-Strand Stainless Steel

Due to the gentle nature of the wire, round stranded wires are traditionally used in early treatment to correct misaligned teeth. Stranded wires apply a low force level over a given span with minor to moderate deformation depending on the severity of the malocclusion. Rectangular stranded wires are typically used in transitional applications to align and detail occlusions effectively with comparatively lower force than solid stainless steel archwires.



Three Strand (Twisted)

SIZE	ROTH [®]		Full-size archform shapes on page 49.			
	MBT [®] SQUARE		STANDARD FORM		14" Straight Lengths	30' Spools
	TRUEFORM [™] I		UPPER	LOWER		
.0155	–	–	–	–	MS3155	SST3155
.0175	–	–	–	–	MS3175	SST3175
.0195	–	–	–	–	MS3195	SST3195
.0215	–	–	–	–	MS3215	SST3215
.016x.016	CTFU1616	CTFL1616	CSFU1616	CSFL1616	MS3616	–
.016x.022	CTFU1622	CTFL1622	CSFU1622	CSFL1622	MS3622	–
.017x.025	CTFU1725	CTFL1725	CSFU1725	CSFL1725	MS3725	–
.018x.025	CTFU1825	CTFL1825	CSFU1825	CSFL1825	MS3825	–
.019x.025	CTFU1925	CTFL1925	CSFU1925	CSFL1925	MS3925	–

Six Strand (Coaxial)

SIZE	14" Straight Lengths	30' Spools
.0155	MS6155	SST6155
.0175	MS6175	SST6175
.0195	MS6195	SST6195
.0215	MS6215	SST6215

Seven Strand (Twisted)

SIZE	14" Straight Lengths	30' Spools
.0155	MS7155	SST7155
.0175	MS7175	SST7175
.0195	MS7195	SST7195
.0215	MS7215	SST7215

.0175 Seven Strand is the most popular wire for bonded lingual retainers.

ORDER OPTIONS



Standard Pack

25 archwires/pack - order numbers as listed.



Solo-Pack[™]

10 individually sealed autoclavable archwires per carton. For Solo-Pack[™] wires, add "S" to the end of part number. Please allow 2-3 days for Solo-Pack[™] packaging.

Eight Strand (Woven)

SIZE	ROTH [®]		Full-size archform shapes on page 49.	
	MBT [®] SQUARE		STANDARD FORM	
	TRUEFORM [™] I		UPPER	LOWER
.016x.016	CTFU8616	CTFL8616	CSFU8616	CSFL8616
.016x.022	CTFU8622	CTFL8622	CSFU8622	CSFL8622
.017x.025	CTFU8725	CTFL8725	CSFU8725	CSFL8725
.018x.025	CTFU8825	CTFL8825	CSFU8825	CSFL8825
.019x.025	CTFU8925	CTFL8925	CSFU8925	CSFL8925
.021x.025	CTFU8125	CTFL8125	CSFU8125	CSFL8125



EIGHT-STRAND STAINLESS STEEL

[®]G&H[®] Orthodontics is in no way affiliated with or endorsed by Ormco Corporation or Dr. Dwight Damon. [™]MBT is a trademark of 3M Unitek.

[®]G&H[®] prescriptions are not implied to be an exact version of any other system, nor do we claim any endorsement by the doctor.

Straight Lengths & Spooled Wire Precision Manufactured By G&H® Orthodontics

Nickel Titanium Straight Lengths and Spools are used for archwire and sectional applications.

Stainless Steel Straight Lengths are manufactured from a 304v spring hard wire suitable for clinical and laboratory applications. Its superior resiliency resists deformation.

TitanMoly™ Titanium Molybdenum Straight Lengths

provides the adaptability and handling characteristics of stainless steel with improved memory and gentler force levels, and its nickel-free alloy helps reduce patient sensitivity.

Colboly™ Blue Nickel Cobalt Wire

is an excellent choice for use in archwires, and is superb for use in removable and functional appliances.

Nickel Titanium

Straight Lengths • 10/tube – Spools, Each

SIZE	7" Straight Lengths	15' Spool
.010	SENT010	SESP010
.012	SENT012	SESP012
.014	SENT014	SESP014
.016	SENT016	SESP016
.018	SENT018	SESP018
.020	SENT020	SESP020
.014x.025	SENT1425	–
.016x.016	SENT1616	–
.016x.022	SENT1622	–
.016x.025	SENT1625	–
.017x.025	SENT1725	–
.018x.018	SENT1818	–
.018x.025	SENT1825	–
.019x.025	SENT1925	–
.020x.020	SENT2020	–
.021x.025	SENT2125	–

Stainless Steel Spring Tempered Wire

Straight Lengths • 25/tube

SIZE	14" Straight Lengths
.012	STSS012
.014	STSS014
.016	STSS016
.018	STSS018
.020	STSS020
.022	STSS022
.024	STSS024
.026	STSS026
.028	STSS028
.030	STSS030
.032	STSS032
.036	STSS036
.040	STSS040
.045	STSS045
.051	STSS051
.016x.016	STSS1616
.016x.022	STSS1622
.017x.017	STSS1717
.017x.022	STSS1722
.017x.025	STSS1725
.018x.018	STSS1818
.018x.022	STSS1822
.018x.025	STSS1825
.019x.019	STSS1919
.019x.025	STSS1925
.020x.020	STSS2020
.021x.025	STSS2125

TitanMoly™ Titanium Molybdenum

Straight Lengths • 10/tube

SIZE	14" Straight Lengths
.016	STB3016
.018	STB3018
.028	STB3028
.032	STB3032
.036	STB3036
.016x.016	STB31616
.016x.022	STB31622
.017x.025	STB31725
.0175x.0175	STB37575
.018x.025	STB31825
.019x.025	STB31925
.021x.025	STB32125

Colboly™ Blue Nickel Cobalt

Straight Lengths • 25/tube

SIZE	14" Straight Lengths
.014	STRCB014
.016	STRCB016
.018	STRCB018
.028	STRCB028
.030	STRCB030
.032	STRCB032
.036	STRCB036
.040	STRCB040
.045	STRCB045
.051	STRCB051
.016x.016	STRCB1616
.016x.022	STRCB1622
.017x.025	STRCB1725
.018x.025	STRCB1825
.019x.025	STRCB1925
.021x.025	STRCB2125



Soft Stainless Steel Wire

.016 annealed soft stainless steel wire is suitable for various applications including securing rapid palatal expander screws and ligating convertible tubes after cap removal.

Order Information:

15 ft. spool

SSSOF016



ARCHWIRE CUTTERS
& PLIERS BEGIN
ON PAGE 119

Colboloy™ Blue – Nickel Cobalt Precision Manufactured By G&H® Orthodontics

Colboloy™ Blue Nickel Cobalt wire, like Elgiloy® wire, is a unique alloy. Colboloy™ Blue allows intricate bending and, if desired, may be heat treated after formation to increase tensile strength and resiliency.

ORDER OPTIONS



Standard Pack

25 archwires/pack - order numbers as listed.



Solo-Pack™

10 individually sealed autoclavable archwires per carton. For Solo-Pack™ wires, add "S" to the end of part number. Please allow 2-3 days for Solo-Pack™ packaging.

SIZE	ROTH [®]		MBT ^{**} TAPERED		BIOFORM I	BIOFORM V
	MBT ^{**} SQUARE		BIOFORM III			
	UPPER	LOWER	UPPER	LOWER		
.014	CBTFU014	CBTFL014	CBBF3U014	CBBF3L014	CBBF114	CBBF514
.016	CBTFU016	CBTFL016	CBBF3U016	CBBF3L016	CBBF116	CBBF516
.018	CBTFU018	CBTFL018	CBBF3U018	CBBF3L018	CBBF118	CBBF518
.016x.016	CBTFU1616	CBTFL1616	CBBF3U1616	CBBF3L1616	CBBF1616	CBBF5616
.016x.022	CBTFU1622	CBTFL1622	CBBF3U1622	CBBF3L1622	CBBF1622	CBBF5622
.017x.022	CBTFU1722	CBTFL1722	–	–	–	–
.017x.025	CBTFU1725	CBTFL1725	CBBF3U1725	CBBF3L1725	CBBF1725	CBBF5725
.018x.025	CBTFU1825	CBTFL1825	CBBF3U1825	CBBF3L1825	CBBF1825	CBBF5825
.019x.025	CBTFU1925	CBTFL1925	CBBF3U1925	CBBF3L1925	CBBF1925	CBBF5925
.021x.025	CBTFU2125	CBTFL2125	–	–	–	–

Stainless Steel Ligature Ties

G&H® Koby Ties

Koby ties provide an auxiliary hook which can be added to any bracket just by tying in the archwire. They are preformed to be easily tied in place and able to fit most orthodontic brackets. Short ties have pre-wound pigtails for extra easy engagement and are made from easily adaptable .012 or .014 ligature wire. Tooth coated (.014) ties combine the strength and security of metal with the aesthetics needed for ceramic or composite brackets.



100/pkg.

	Long	Short
.010	KH010	.012 SKH012
.012	KH012	.014 SKH014
.014	KH014	.014 TSKH014 (Tooth colored)

Spoiled Bulk Ligature Wire

Our spoiled ligature wire is diamond drawn to exacting dimension and features a bright finish with soft temper for ease of use.

1 lb. spool

.008	(5,827 ft.)	SBLW108
.009	(4,382 ft.)	SBLW109
.010	(3,730 ft.)	SBLW110
.011	(3,075 ft.)	SBLW111
.012	(2,612 ft.)	SBLW112



Stainless Steel Ligature Ties

Preformed in dead soft temper.

Long

.008 (1,000/pkg.)	LT008
.009 (1,000/pkg.)	LT009
.010 (1,000/pkg.)	LT010
.011 (1,000/pkg.)	LT011
.012 (1,000/pkg.)	LT012
.012 (100/pkg. Tooth-Colored)	TCLT012
.014 (500/pkg.)	LT014



Pre-cut Ligature Ties

.008 Standard (500/pkg.)	SLT008
Applicable for lingual bracket engagement	
.010 Standard (500/pkg.)	SLT010
.012 Tooth color (50/pkg.)	TCSLT012L



A.J. Wilcock®

Brass Separating Wire

Brass Separating Wire is high quality corrosion resistant 60/40 brass for posterior separation prior to band placement.

8 oz. reel

.018 (545 ft.)	AW820-018
.020 (450 ft.)	AW820-020

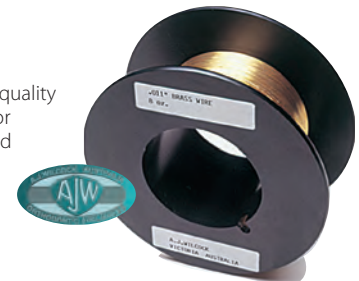

®G&H® Orthodontics is in no way affiliated with or endorsed by Ormco Corporation or Dr. Dwight Damon. **MBT is a trademark of 3M Unitek.

®G&H® prescriptions are not implied to be an exact version of any other system, nor do we claim any endorsement by the doctor.



A.J. Wilcock® Australian Wire Products World famous, never duplicated.

A.J. Wilcock® Australian Wire is imported exclusively to North America through G&H® Orthodontics. These world-renowned stainless steel wire products offer superior hardness and tensile strength for a multitude of applications where exceptional resiliency is desired.

A.J. Wilcock® Australian Wire has earned its reputation as the finest stainless steel of its kind. Strain aged processing ensures extraordinary resilience simply not found in any other orthodontic wire product.



Choose the grade that best meets your clinical needs

Stiff Wire →

← *Stiffest Wire*

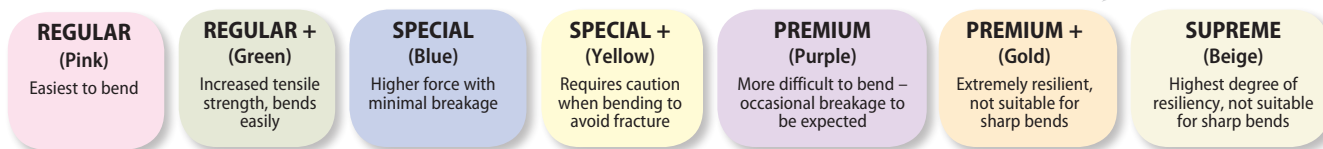

REGULAR (Pink)

Easiest to bend

REGULAR+ (Green)

Increased tensile strength, bends easily

SPECIAL (Blue)

Higher force with minimal breakage

SPECIAL+ (Yellow)

Requires caution when bending to avoid fracture

PREMIUM (Purple)

More difficult to bend – occasional breakage to be expected

PREMIUM+ (Gold)

Extremely resilient, not suitable for sharp bends

SUPREME (Beige)

Highest degree of resiliency, not suitable for sharp bends

↑ *Used Most Often* ↓



25 ft./spool

SIZE	REGULAR PINK	REGULAR+ GREEN	SPECIAL BLUE	SPECIAL+ YELLOW	PREMIUM PURPLE	PREMIUM+ GOLD	SUPREME BEIGE
.009	–	–	–	–	–	–	AW227-060
.010	–	–	–	–	–	AW228-050	AW228-060
.011	–	–	–	–	–	AW228-150	AW228-160
.012	AW229-000	AW229-010	AW229-020	AW229-030	AW229-040	AW229-050	–
.014	AW230-100	AW230-110	AW230-120	AW230-130	AW230-140	AW230-150	–
.016	AW231-300	AW231-310	AW231-320	AW231-330	AW231-340	AW231-350	–
.018	AW232-400	AW232-410	AW232-420	AW232-430	AW232-440	AW232-450	–
.020	AW233-500	AW233-510	AW233-520	AW233-530	AW233-540	–	–
.022	AW234-600	–	–	AW234-630	–	–	–
.024	AW235-700	–	AW235-720	AW235-730	–	–	–

A.J. Wilcock® Pulse Straightened

Australian Wire improves martensitic response and smooth surface characteristics for reduced friction.



Pulse Straightened 10" Straight Lengths – Round - 30/tube

SIZE	REGULAR PINK	REGULAR+ GREEN	SPECIAL BLUE	SPECIAL+ YELLOW	PREMIUM PURPLE	PREMIUM+ GOLD	SUPREME BEIGE
.009	–	–	–	–	–	–	–
.010	–	–	–	–	–	–	AW228-061
.012	–	–	–	–	–	AW229-051	–
.014	AW230-101	AW230-111	AW230-121	AW230-131	–	AW230-151	–
.016	AW231-301	AW231-311	AW231-321	AW231-331	–	AW231-351	–
.018	AW232-401	AW232-411	AW232-421	AW232-431	–	–	–
.020	AW233-501	AW233-511	AW233-521	AW233-531	AW233-541	–	–
.022	–	–	–	AW234-631	–	–	–

Rectangular - 10/tube

SIZE	SPECIAL BLUE	SPECIAL+ YELLOW
.016 x .016	AW601-616	AW611-616
.016 x .022	AW700-622	–
.018 x .025	AW700-825	–
.019 x .025	AW700-925	–



A.J. Wilcock® Preformed Arches World famous, never duplicated.

Preformed Australian Archwires are unsurpassed in resiliency and hardness with incredible levels of stored energy for rapid tooth alignment. Preformed round arches are made from Premium, Premium Plus and Special Plus Grade Australian wire. (Premium and Premium Plus are not recommended for intricate bends.) Preformed rectangular arches are manufactured from Special Plus Grade Australian wire. All Wilcock® rectangular archwires are sharp cornered with minimal radius to deliver highest possible torque values and maintain exacting specifications.

Round Wire Arches - 25/pack

GRADE/SIZE	ROTH™		STANDARD FORM	
	MBT™ SQUARE		TRUEFORM™ I	
	UPPER	LOWER	UPPER	LOWER
Special+				
.014	AWTFU014SP+	AWTFL014SP+	AWSFU014SP+	–
.016	AWTFU016SP+	AWTFL016SP+	AWSFU016SP+	AWSFL016SP+
.018	AWTFU018SP+	AWTFL018SP+	AWSFU018SP+	AWSFL018SP+
.020	AWTFU020SP+	AWTFL020SP+	AWSFU020SP+	–
.022	AWTFU022SP+	AWTFL022SP+	–	–
Premium				
.020	AWTFU020	AWTFL020	–	–
Premium+				
.016	AWTFU016	AWTFL016	AWSFU016	AWSFL016
.018	AWTFU018	AWTFL018	N/A	N/A

■ Premium and Premium+ are not recommended for intricate bends

Rectangular Wire Arches - 25/pack

GRADE/SIZE	ROTH™	
	MBT™ SQUARE	
	UPPER	LOWER
Special+		
.016x.016	AWTFU1616	AWTFL1616
.016x.022	AWTFU1622	AWTFL1622
.017x.025	AWTFU1725	AWTFL1725
.018x.018	AWTFU1818	AWTFL1818
.018x.025	AWTFU1825	–
.019x.025	AWTFU1925	AWTFL1925
.021x.025	AWTFU2125	–

MIDLINE ID Australian arches are ink-midline marked (Blue for Upper and White for Lower) or etched depending on wire color.



A.J. Wilcock® Combination Arches World famous, never duplicated.

These unique, highly resilient Special Plus Grade stainless steel wires are ideal for maintaining arch shape even when other auxiliaries and elastics are being used. Combination wires are rectangular in the anterior segment to maintain torque while the round posterior segments allow sliding mechanics with reduced friction.

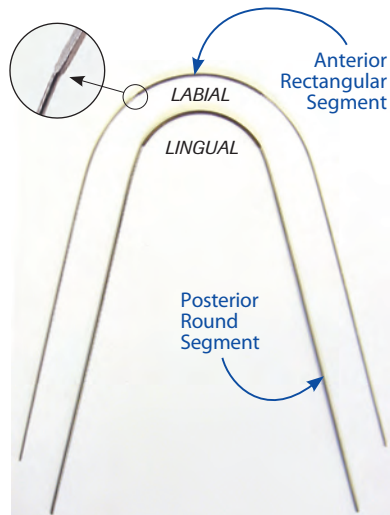

Combination Labial Archwires Standard Form - Special+ Grade 2/pack

SIZE

Anterior	Posterior	
.016x.022	.016	AW771-622*
.017x.025	.017	AW771-725*
.018x.025	.018	AW771-825*
.019x.025	.019	AW771-925*

*Insert millimeter span of anterior segment 26 - 44 in 2 mm increments.

Combination Lingual Archwires Universal Archform - Special+ Grade 2/pack

SIZE

Anterior	Posterior	
.016x.022	.016	AW671-622*
.017x.025	.017	AW671-725*
.021x.025	.021	AW672-125*

*Insert millimeter span of anterior segment 26 - 38 in 2 mm increments.

**MBT is a trademark of 3M Unitek.

°G&H® prescriptions are not implied to be an exact version of any other system, nor do we claim any endorsement by the doctor.

Additional Archform Shapes

ARCHFORMS ARE PICTURED ACTUAL SIZE.

See pages 80-82 for available dimensions, alloys, and order numbers.

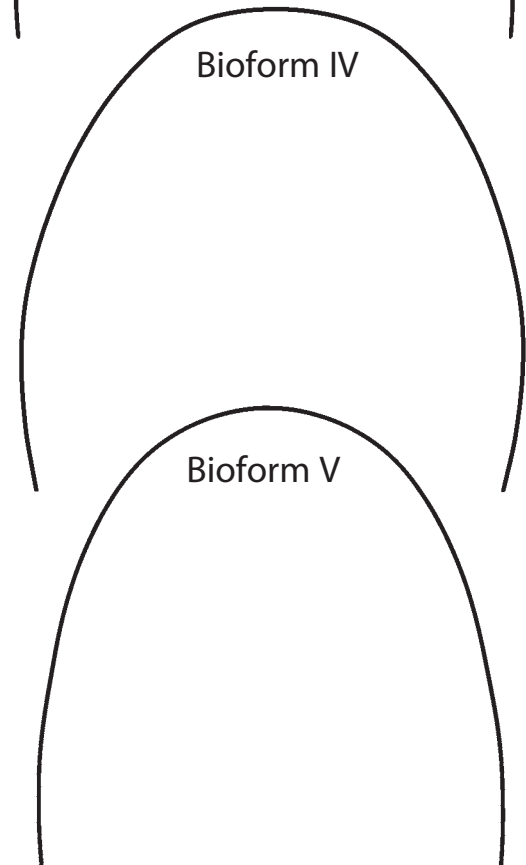
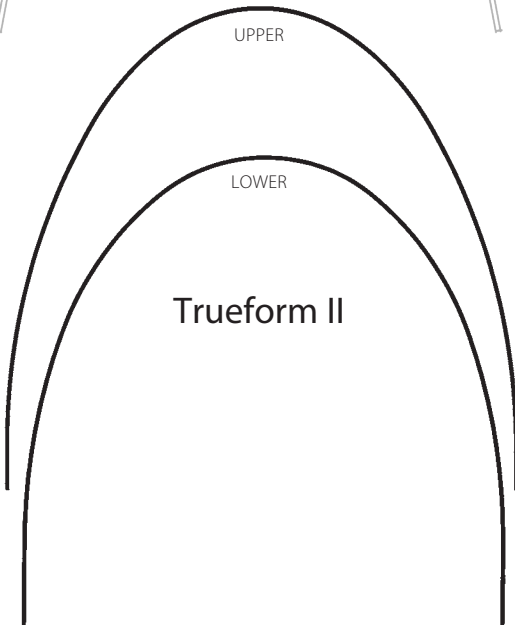
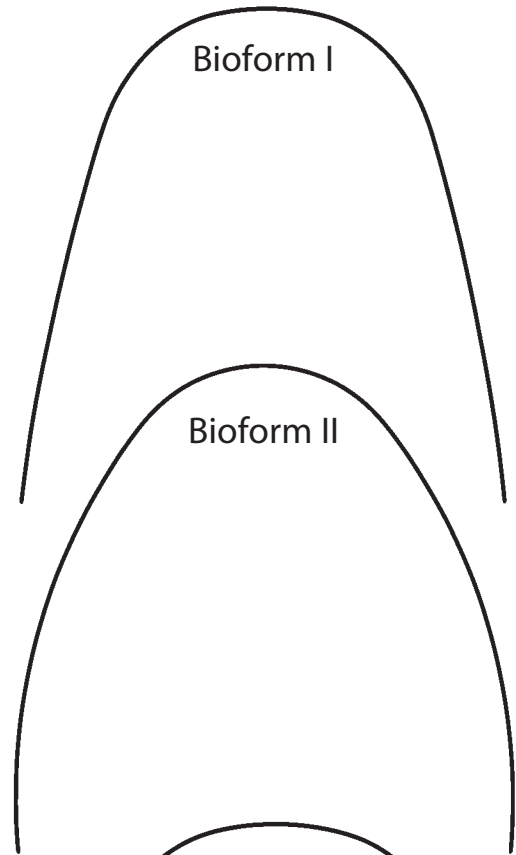
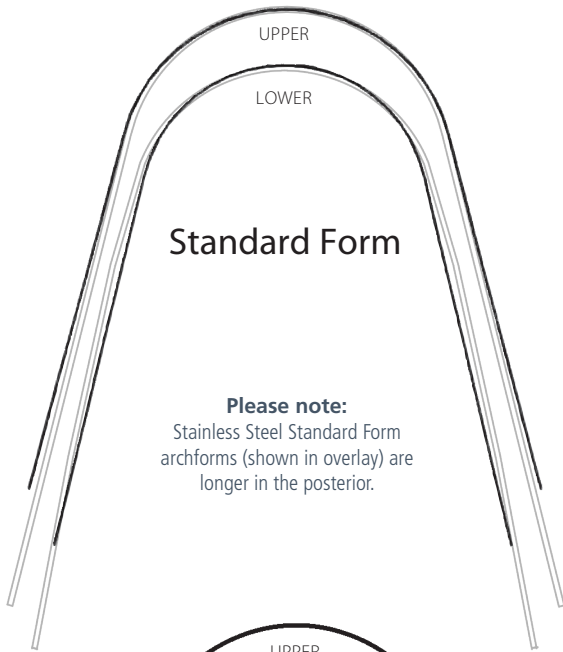

Compare size to scale for reproduction distortion.

Additional Archform Shapes Precision Manufactured By G&H® Orthodontics

Full-size archform shapes on page 79.

G4™ Nickel Titanium Archwires								
Size	STANDARD FORM		TRUEFORM™ II		BIOFORM I	BIOFORM II	BIOFORM IV	BIOFORM V
	UPPER	LOWER	UPPER	LOWER				
.012	G4SFU012	G4SFL012	G4TFU112	G4TFL112	G4BF112	G4BF212	G4BF412	G4BF512
.014	G4SFU014	G4SFL014	G4TFU114	G4TFL114	G4BF114	G4BF214	G4BF414	G4BF514
.016	G4SFU016	G4SFL016	G4TFU116	G4TFL116	G4BF116	G4BF216	G4BF416	G4BF516
.018	G4SFU018	G4SFL018	G4TFU118	G4TFL118	G4BF118	G4BF218	G4BF418	G4BF518
.020	G4SFU020	G4SFL020	G4TFU120	G4TFL120	G4BF120	G4BF220	G4BF420	G4BF520
.016x.016	G4SFU1616	G4SFL1616	G4TFU3616	G4TFL3616	G4BF11616	G4BF21616	G4BF41616	G4BF51616
.016x.022	G4SFU1622	G4SFL1622	G4TFU3622	G4TFL3622	G4BF11622	G4BF21622	G4BF41622	G4BF51622
.017x.025	G4SFU1725	G4SFL1725	G4TFU3725	G4TFL3725	G4BF11725	G4BF21725	G4BF41725	G4BF51725
.018x.018	G4SFU1818	G4SFL1818	G4TFU3818	G4TFL3818	G4BF11818	G4BF21818	G4BF41818	G4BF51818
.018x.025	G4SFU1825	G4SFL1825	G4TFU3825	G4TFL3825	G4BF11825	G4BF21825	G4BF41825	G4BF51825
.019x.025	G4SFU1925	G4SFL1925	G4TFU3925	G4TFL3925	G4BF11925	G4BF21925	G4BF41925	G4BF51925
.020x.020	G4SFU2020	G4SFL2020	G4TFU3020	G4TFL3020	G4BF12020	G4BF22020	G4BF42020	G4BF52020
.021x.025	G4SFU2125	G4SFL2125	G4TFU3125	G4TFL3125	G4BF12125	G4BF22125	G4BF42125	G4BF52125

M5™ Thermal Copper Nickel Titanium Archwires								
Size	STANDARD FORM		TRUEFORM™ II		BIOFORM I	BIOFORM II	BIOFORM IV	BIOFORM V
	UPPER	LOWER	UPPER	LOWER				
.012	M5SFU012	M5SFL012	M5TFU112	M5TFL112	M5BF112	M5BF212	M5BF412	M5BF512
.014	M5SFU014	M5SFL014	M5TFU114	M5TFL114	M5BF114	M5BF214	M5BF414	M5BF514
.016	M5SFU016	M5SFL016	M5TFU116	M5TFL116	M5BF116	M5BF216	M5BF416	M5BF516
.018	M5SFU018	M5SFL018	M5TFU118	M5TFL118	M5BF118	M5BF218	M5BF418	M5BF518
.020	M5SFU020	M5SFL020	M5TFU120	M5TFL120	M5BF120	M5BF220	M5BF420	M5BF520
.016x.016	M5SFU1616	M5SFL1616	M5TFU3616	M5TFL3616	M5BF11616	M5BF21616	M5BF41616	M5BF51616
.016x.022	M5SFU1622	M5SFL1622	M5TFU3622	M5TFL3622	M5BF11622	M5BF21622	M5BF41622	M5BF51622
.017x.025	M5SFU1725	M5SFL1725	M5TFU3725	M5TFL3725	M5BF11725	M5BF21725	M5BF41725	M5BF51725
.018x.018	M5SFU1818	M5SFL1818	M5TFU3818	M5TFL3818	M5BF11818	M5BF21818	M5BF41818	M5BF51818
.018x.025	M5SFU1825	M5SFL1825	M5TFU3825	M5TFL3825	M5BF11825	M5BF21825	M5BF41825	M5BF51825
.019x.025	M5SFU1925	M5SFL1925	M5TFU3925	M5TFL3925	M5BF11925	M5BF21925	M5BF41925	M5BF51925
.020x.020	M5SFU2020	M5SFL2020	M5TFU3020	M5TFL3020	M5BF12020	M5BF22020	M5BF42020	M5BF52020
.021x.025	M5SFU2125	M5SFL2125	M5TFU3125	M5TFL3125	M5BF12125	M5BF22125	M5BF42125	M5BF52125

ORDER OPTIONS

Standard Pack

25 archwires/pack - order numbers as listed

Solo-Pack™

10 individually sealed autoclavable archwires per carton.
For Solo-Pack™ wires, add "S" to the end of part number.
Please allow 2-3 days for Solo-Pack™ packaging.

Optional Dimpled Midline

For Dimpled Midline wires, add "D" to the end of part number – for Dimpled Solo-Pack™ add "DS" to the end of part number.

Additional Archform Shapes Precision Manufactured By G&H® Orthodontics

Full-size archform shapes on page 79.

TitanMoly™ Titanium Molybdenum Archwires		
Size	STANDARD FORM	
	UPPER	LOWER
.016	B3SFU016	B3SFL016
.018	B3SFU018	B3SFL018
.016x.016	B3SFU1616	B3SFL1616
.016x.022	B3SFU1622	B3SFL1622
.017x.025	B3SFU1725	B3SFL1725
.0175x.0175	B3SFU7575	B3SFL7575
.018x.025	B3SFU1825	B3SFL1825
.019x.025	B3SFU1925	B3SFL1925
.021x.025	B3SFU2125	B3SFL2125

ORDER OPTIONS

Standard Pack

10 archwires/pack - order numbers as listed

Solo-Pack™

10 individually sealed autoclavable archwires per carton.
For Solo-Pack™ wires, add "S" to the end of part number.
Please allow 2-3 days for Solo-Pack™ packaging.

S3™ Stainless Steel Archwires

Size	STANDARD FORM		TRUEFORM™ II		BIOFORM I	BIOFORM II	BIOFORM IV	BIOFORM V
	UPPER	LOWER	UPPER	LOWER				
.012	S3SFU012	S3SFL012	S3TFU112	S3TFL112	S3BF112	S3BF212	S3BF412*	S3BF512
.014	S3SFU014	S3SFL014	S3TFU114	S3TFL114	S3BF114	S3BF214	S3BF414	S3BF514
.016	S3SFU016	S3SFL016	S3TFU116	S3TFL116	S3BF116	S3BF216	S3BF416	S3BF516
.018	S3SFU018	S3SFL018	S3TFU118	S3TFL118	S3BF118	S3BF218	S3BF418	S3BF518
.020	S3SFU020	S3SFL020	S3TFU120	S3TFL120	S3BF120	S3BF220	S3BF420	S3BF520
.016x.016	S3FU1616	S3SFL1616	S3TFU3616	S3TFL3616	S3BF11616	S3BF21616	S3BF41616	S3BF51616
.016x.022	S3SFU1622	S3SFL1622	S3TFU3622	S3TFL3622	S3BF11622	S3BF21622	S3BF41622	S3BF51622
.017x.017	S3SFU1717	S3SFL1717	S3TFU3717	S3TFL3717	S3BF11717	S3BF21717	S3BF41717	S3BF51717
.017x.022	S3SFU1722	S3SFL1722	S3TFU3722*	S3TFL3722	S3BF11722	S3BF21722	S3BF41722	S3BF51722
.017x.025	S3SFU1725	S3SFL1725	S3TFU3725	S3TFL3725	S3BF11725	S3BF21725	S3BF41725	S3BF51725
.018x.018	S3SFU1818	S3SFL1818	S3TFU3818	S3TFL3818	S3BF11818	S3BF21818	S3BF41818	S3BF51818
.018x.022	S3SFU1822	S3SFL1822	S3TFU3822	S3TFL3822	S3BF11822	S3BF21822	S3BF41822	S3BF51822
.018x.025	S3SFU1825	S3SFL1825	S3TFU3825	S3TFL3825	S3BF11825	S3BF21825	S3BF41825	S3BF51825
.019x.019	S3SFU1919	S3SFL1919	S3TFU3919	S3TFL3919	S3BF11919	S3BF21919	S3BF41919	S3BF51919
.019x.025	S3SFU1925	S3SFL1925	S3TFU3925	S3TFL3925	S3BF11925	S3BF21925	S3BF41925	S3BF51925
.020x.020	S3SFU2020	S3SFL2020	S3TFU3020	S3TFL3020	S3BF12020	S3BF22020	S3BF42020	S3BF52020
.021x.025	S3SFU2125	S3SFL2125	S3TFU3125	S3TFL3125	S3BF12125	S3BF22125	S3BF42125	S3BF52125

ORDER OPTIONS

Standard Pack

25 archwires/pack - order numbers as listed

Solo-Pack™

10 individually sealed autoclavable archwires per carton.
For Solo-Pack™ wires, add "S" to the end of part number.
Please allow 2-3 days for Solo-Pack™ packaging.

ARCHWIRE CUTTERS
& PLIERS BEGIN
ON PAGE 119

Additional Archform Shapes Precision Manufactured By G&H® Orthodontics

Full-size archform shapes on page 79.

XR1™ Heat-Treated Stainless Steel Archwires

Size	STANDARD FORM		TRUEFORM™ II		BIOFORM I	BIOFORM II	BIOFORM IV	BIOFORM V
	UPPER	LOWER	UPPER	LOWER				
.012	XRSFU012	XRSFL012	XRTFU112	XRTFL112	XRBF112	XRBF212	XRBF412	XRBF512
.014	XRSFU014	XRSFL014	XRTFU114	XRTFL114	XRBF114	XRBF214	XRBF414	XRBF514
.016	XRSFU016	XRSFL016	XRTFU116	XRTFL116	XRBF116	XRBF216	XRBF416	XRBF516
.018	XRSFU018	XRSFL018	XRTFU118	XRTFL118	XRBF118	XRBF218	XRBF418	XRBF518
.020	XRSFU020	XRSFL020	XRTFU120	XRTFL120	XRBF120	XRBF220	XRBF420	XRBF520
.016x.016	XRUFU1616	XRSFL1616	XRTFU3616	XRTFL3616	XRBF11616	XRBF21616	XRBF41616	XRBF51616
.016x.022	XRSFU1622	XRSFL1622	XRTFU3622	XRTFL3622	XRBF11622	XRBF21622	XRBF41622	XRBF51622
.017x.017	XRSFU1717	XRSFL1717	XRTFU3717	XRTFL3717	XRBF11717	XRBF21717	XRBF41717	XRBF51717
.017x.022	XRSFU1722	XRSFL1722	XRTFU3722	XRTFL3722	XRBF11722	XRBF21722	XRBF41722	XRBF51722
.017x.025	XRSFU1725	XRSFL1725	XRTFU3725	XRTFL3725	XRBF11725	XRBF21725	XRBF41725	XRBF51725
.018x.018	XRSFU1818	XRSFL1818	XRTFU3818	XRTFL3818	XRBF11818	XRBF21818	XRBF41818	XRBF51818
.018x.022	XRSFU1822	XRSFL1822	XRTFU3822	XRTFL3822	XRBF11822	XRBF21822	XRBF41822	XRBF51822
.018x.025	XRSFU1825	XRSFL1825	XRTFU3825	XRTFL3825	XRBF11825	XRBF21825	XRBF41825	XRBF51825
.019x.025	XRSFU1925	XRSFL1925	XRTFU3925	XRTFL3925	XRBF11925	XRBF21925	XRBF41925	XRBF51925
.020x.020	XRSFU2020	XRSFL2020	XRTFU3020	XRTFL3020	XRBF12020	XRBF22020	XRBF42020	XRBF52020
.021x.025	XRSFU2125	XRSFL2125	XRTFU3125	XRTFL3125	XRBF12125	XRBF22125	XRBF42125	XRBF52125

ORDER OPTIONS

Standard Pack

25 archwires/pack - order numbers as listed

Solo-Pack™

10 individually sealed autoclavable archwires per carton.
For Solo-Pack™ wires, add "S" to the end of part number.
Please allow 2-3 days for Solo-Pack™ packaging.

ARCHWIRE CUTTERS
& PLIERS BEGIN
ON PAGE 119



G&H is recognized as the world's best manufacturer of premium archwires and G&H precision manufacturing processes make the difference.

DYB™ Pre-Torqued Archwire Series Precision Manufactured By G&H® Orthodontics

Simultaneous crown torque and progressive arch expansion with one archwire.

DYB™-V3 & V3 92% Archforms - 10 wires per pkg - bulk pack.

DYB™-V3 - S304 Stainless Steel

Dimension	0° Torque	15° Torque
.017x.025	S3DYBU1725	S3DYBU1725TQ
.018x.018	S3DYBU1818	S3DYBU1818TQ
.019x.025	S3DYBU1925	S3DYBU1925TQ
.020x.020	S3DYBU2020	S3DYBU2020TQ

DYB™-V3 92% - S304 Stainless Steel

Dimension	0° Torque	15° Torque
.017x.025	S3DYB92U1725	S3DYB92U1725TQ
.018x.018	S3DYB92U1818	S3DYB92U1818TQ
.019x.025	S3DYB92U1925	S3DYB92U1925TQ
.020x.020	S3DYB92U2020	S3DYB92U2020TQ

DYB™-V3 - TitanMoly™ Titanium Molybdenum

Dimension	0° Torque	20° Torque
.017x.025	B3DYBU1725	B3DYBU1725TQ
.019x.025	B3DYBU1925	B3DYBU1925TQ
.020x.020	B3DYBU2020	B3DYBU2020TQ

DYB™-V3 92% - TitanMoly™ Titanium Molybdenum

Dimension	0° Torque	20° Torque
.017x.025	B3DYB92U1725	B3DYB92U1725TQ
.019x.025	B3DYB92U1925	B3DYB92U1925TQ
.020x.020	B3DYB92U2020	B3DYB92U2020TQ

DYB™-V3 - G4™ Nickel Titanium

Dimension	0° Torque	With Pre-Loaded Stops
.014	G4DYBU014	G4DYBU014CB
.016	G4DYBU016	G4DYBU016CB
.014x.025	G4DYBU1425	G4DYBU1425CB
.017x.025	G4DYBU1725	G4DYBU1725CB
.018x.018	G4DYBU1818*	G4DYBU1818CB
.019x.025	G4DYBU1925	G4DYBU1925CB
.020x.020	G4DYBU2020	G4DYBU2020CB

DYB™-V3 92% - G4™ Nickel Titanium

Dimension	0° Torque	With Pre-Loaded Stops
.014	G4DYB92U014	G4DYB92U014CB
.016	G4DYB92U016	G4DYB92U016CB
.014x.025	G4DYB92U1425	G4DYB92U1425CB
.017x.025	G4DYB92U1725	G4DYB92U1725CB
.018x.018	G4DYB92U1818	G4DYB92U1818CB
.019x.025	G4DYB92U1925	G4DYB92U1925CB
.020x.020	G4DYB92U2020	G4DYB92U2020CB

Also available –

DYB™ Europa™ II Archform - With or without torque, Damon®-Compatible

EF2 - S304 Stainless Steel

Dimension	0° Torque	15° Torque
.017x.025	S3EFU3725	S3EFU3725TQ
.019x.025	S3EFU3925	S3EFU3925TQ
.020x.020	S3EFU3020	S3EFU3020TQ

Package of 25, bulk pack Package of 10, bulk pack

EF2 - TitanMoly™ Titanium Molybdenum

Dimension	0° Torque	20° Torque
.017x.025	B3EFU3725	B3EFU3725TQ
.019x.025	B3EFU3925	B3EFU3925TQ
.020x.020	B3EFU3020	B3EFU3020TQ

Package of 10, bulk pack Package of 10, bulk pack

EF2 - G4™ Nickel Titanium

Dimension	0° Torque
.017x.025	G4EFU3725
.019x.025	G4EFU3925
.020x.020	G4EFU3020

Package of 25, bulk pack

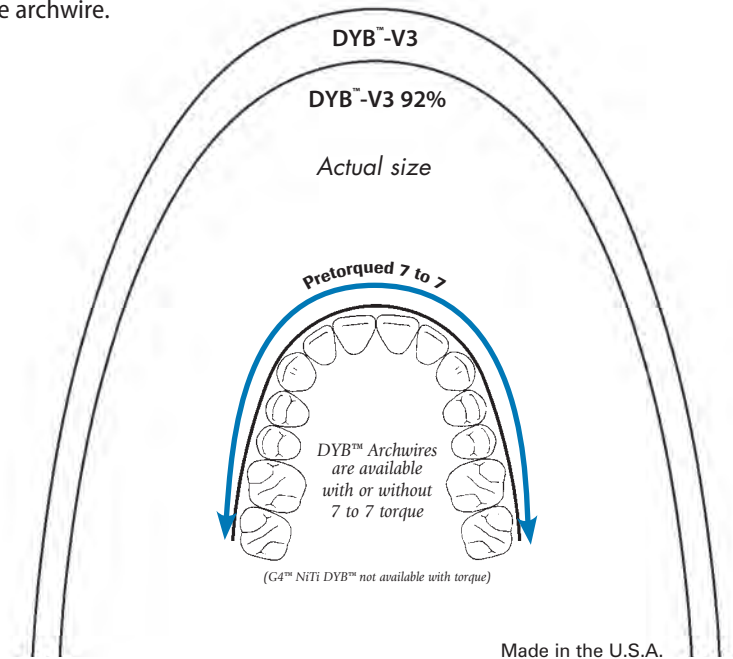

For complete information on the DYB arch system, see our website. Other anterior pretorqued archwires also available - see pages 58 & 61 of the catalog or our website, www.ghortho.com



Dr. Brown

About Duncan Y. Brown BSC, DDS

Dr. Brown graduated from the University of Toronto in 1975 with a Doctor of Dental Surgery and became certified as a Specialist in Orthodontics in 1978.

*G&H® Orthodontics is in no way affiliated with or endorsed by Ormco Corporation or Dr. Dwight Damon. **MBT is a trademark of 3M Unitek. **G&H® prescriptions are not implied to be an exact version of any other system, nor do we claim any endorsement by the doctor.

Platinum Proportion™ Archforms Precision Manufactured By G&H® Orthodontics

Achieve Platinum Proportion™ Finished Smiles - Routinely - with Large or Small Tooth Masses

Small teeth and/or spacing can result in less than perfect smiles

These archforms are designed for treatment of patients with smaller tooth anatomy and/or spacing. After measuring anterior teeth for over five years, we have crystallized a method to consistently deliver a predictable anterior display while idealizing functional coupling of anterior teeth. The

Platinum Proportion™ archwire system takes the guess work out of archwire selection based on a simple system of measuring tooth width of the anterior cuspid to cuspid. This technique definitively provides the clinician the proper archwire based on the consolidated width.

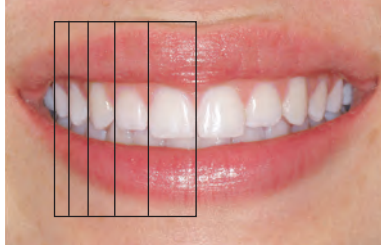

Platinum Proportion™ Gradation for Optimum Aesthetics



Cuspids on the "Sweet Spot" Harmonious progression of gradation



Broken Gradation Canines positioned anterior to the "Sweet Spot"

The Platinum Proportion™ Archwires

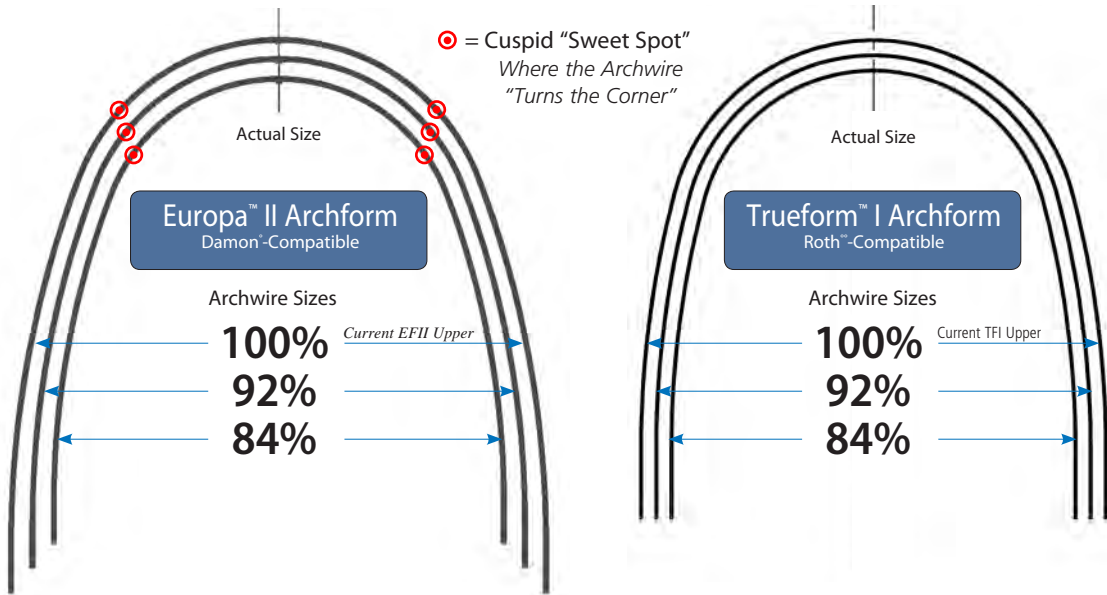

Determining the proper archwire size



Measure Upper Anteriors

- Measure the mesiodistal width of each upper tooth from cuspid to cuspid
- The total measurement of all 6 teeth is then used to prescribe archform size, 100%, 92% or 84%

3	2	1	1	2	3
6.7	7.3	8.4	8.3	7.2	6.9
TOTAL = 44.8					

This case displays a consolidate width of 44.8 mm, indicating consideration of archforms 92% upper and 84% lower. (Digital Caliper available on page 125)

Consolidated width 3 2 1 | 1 2 3 indicates archform size:

- 40mm or Less = Customize 84%
- 40mm - 45mm = 92% Upper & 84% Lower
- 45mm - 50mm = 100% Upper & 92% Lower
- 50mm or More = Customize 100%

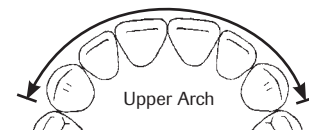

*G&H® Orthodontics is in no way affiliated with or endorsed by Ormco Corporation or Dr. Dwight Damon. **MBT is a trademark of 3M Unitek.
 °G&H® prescriptions are not implied to be an exact version of any other system, nor do we claim any endorsement by the doctor.

Platinum Proportion™ Europa™II Universal Damon®-Compatible

• Bulk Pack – NiTi & Stainless = 25 pkg. • TitanMoly™ = 10 pkg. • Solo-Pack™ = 10/pack (CB)=Crimpable Stops (S)=Solo-Pack

	G4 Nickel Titanium			TitanMoly™ Titanium Molybdenum			S304 Stainless Steel		
	100%	92%	84%	100%	92%	84%	100%	92%	84%
.012	G4EFU112 (CB) (S)	G4EFM112 (CB) (S)	G4EFS112 (CB) (S)	-	-	-	S3EFU112(S)	-	-
.013	G4EFU113 (CB) (S)	G4EFM113 (CB) (S)	G4EFS113 (CB) (S)	-	-	-	-	-	-
.014	G4EFU114 (CB) (S)	G4EFM114 (CB) (S)	G4EFS114 (CB) (S)	-	-	-	S3EFU114(S)	-	-
.016	G4EFU116 (CB) (S)	G4EFM116 (CB) (S)	G4EFS116 (CB) (S)	-	-	-	S3EFU116(S)	-	-
.018	G4EFU118 (CB) (S)	G4EFM118 (CB) (S)	G4EFS118 (CB) (S)	-	-	-	S3EFU118(S)	S3EFM118(S)	S3EFS118(S)
.020	G4EFU120 (CB) (S)	G4EFM120 (CB) (S)	G4EFS120 (CB) (S)	-	-	-	S3EFU120(S)	S3EFM120(S)	S3EFS120(S)
.014 x .025	G4EFU3425 (CB) (S)	G4EFM3425 (CB) (S)	G4EFS3425 (CB) (S)	-	-	-	-	-	-
.016 x .016	G4EFU3616 (CB) (S)	G4EFM3616 (CB) (S)	G4EFS3616 (CB) (S)	-	-	-	S3EFU3616(S)	-	-
.016 x .022	G4EFU3622 (CB) (S)	G4EFM3622 (CB) (S)	G4EFS3622 (CB) (S)	B3EFU3622 (S)	B3EFM3622 (S)	B3EFS3622 (S)	S3EFU3622(S)	S3EFM3622 (S)	S3EFS3622 (S)
.016 x .025	G4EFU3625 (CB) (S)	G4EFM3625 (CB) (S)	G4EFS3625 (CB) (S)	-	-	-	S3EFU3625(S)	S3EFM3625 (S)	S3EFS3625 (S)
.017 x .017	G4EFU3717 (CB) (S)	G4EFM3717 (CB) (S)	G4EFS3717 (CB) (S)	-	-	-	S3EFU3717(S)	-	-
.017 x .025	G4EFU3725 (CB) (S)	G4EFM3725 (CB) (S)	G4EFS3725 (CB) (S)	B3EFU3725 (S)	B3EFM3725 (S)	B3EFS3725 (S)	S3EFU3725(S)	S3EFM3725 (S)	S3EFS3725 (S)
.018 x .018	G4EFU3818 (CB) (S)	G4EFM3818 (CB) (S)	G4EFS3818 (CB) (S)	-	-	-	S3EFU3818(S)	-	-
.018 x .025	G4EFU3825 (CB) (S)	G4EFM3825 (CB) (S)	G4EFS3825 (CB) (S)	-	-	-	S3EFU3825(S)	S3EFM3825 (S)	S3EFS3825 (S)
.019 x .025	G4EFU3925 (CB) (S)	G4EFM3925 (CB) (S)	G4EFS3925 (CB) (S)	B3EFU3925 (S)	B3EFM3925 (S)	B3EFS3925 (S)	S3EFU3925(S)	S3EFM3925 (S)	S3EFS3925 (S)
.020 x .020	G4EFU3020 (CB) (S)	G4EFM3020 (CB) (S)	G4EFS3020 (CB) (S)	-	-	-	S3EFU3020(S)	S3EFM3020 (S)	S3EFS3020 (S)
.021 x .025	G4EFU3125 (CB) (S)	G4EFM3125 (CB) (S)	G4EFS3125 (CB) (S)	B3EFU3125 (S)	B3EFM3125 (S)	B3EFS3125 (S)	S3EFU3125(S)	S3EFM3125 (S)	S3EFS3125 (S)

Platinum Proportion™ Trueform™I

Heat-treated stainless steel Platinum Proportion archwires also available on request.

• Bulk Pack – NiTi & Stainless = 25 pkg. • TitanMoly™ = 10 pkg. • Solo-Pack™ = 10/pack (CB)=Crimpable Stops (S)=Solo-Pack

	G4 Nickel Titanium			TitanMoly™ Titanium Molybdenum			S304 Stainless Steel		
	100%	92%	84%	100%	92%	84%	100%	92%	84%
.012	G4TFU012 (CB) (S)	G4TFM012 (CB) (S)	G4TFS012 (CB) (S)	-	-	-	S3TFU012(S)	-	-
.013	G4TFU013 (CB) (S)	G4TFM013 (CB) (S)	G4TFS013 (CB) (S)	-	-	-	-	-	-
.014	G4TFU014 (CB) (S)	G4TFM014 (CB) (S)	G4TFS014 (CB) (S)	-	-	-	S3TFU014(S)	-	-
.016	G4TFU016 (CB) (S)	G4TFM016 (CB) (S)	G4TFS016 (CB) (S)	-	-	-	S3TFU016(S)	-	-
.018	G4TFU018 (CB) (S)	G4TFM018 (CB) (S)	G4TFS018 (CB) (S)	-	-	-	S3TFU018(S)	S3TFM018 (S)	-
.020	-	-	-	-	-	-	S3TFU020(S)	S3TFM020 (S)	-
.014 x .025	G4TFU1425 (CB) (S)	G4TFM1425 (CB) (S)	G4TFS1425 (CB) (S)	-	-	-	-	-	-
.016 x .016	G4TFU1616 (CB) (S)	G4TFM1616 (CB) (S)	G4TFS1616 (CB) (S)	-	-	-	S3TFU1616(S)	-	-
.016 x .022	G4TFU1622 (CB) (S)	G4TFM1622 (CB) (S)	G4TFS1622 (CB) (S)	B3TFU1622 (S)	B3TFM1622 (S)	B3TFS1622 (S)	S3TFU1622(S)	S3TFM1622 (S)	S3TFS1622 (S)
.016 x .025	G4TFU1625 (CB) (S)	G4TFM1625 (CB) (S)	G4TFS1625 (CB) (S)	-	-	-	S3TFU1625(S)	S3TFM1625 (S)	S3TFS1625 (S)
.017 x .017	G4TFU1717 (CB) (S)	G4TFM1717 (CB) (S)	G4TFS1717 (CB) (S)	-	-	-	S3TFU1717(S)	S3TFM1717 (S)	S3TFS1717 (S)
.017 x .025	G4TFU1725 (CB) (S)	G4TFM1725 (CB) (S)	G4TFS1725 (CB) (S)	B3TFU1725 (S)	B3TFM1725 (S)	B3TFS1725 (S)	S3TFU1725(S)	S3TFM1725 (S)	S3TFS1725 (S)
.018 x .018	G4TFU1818 (CB) (S)	G4TFM1818 (CB) (S)	-	-	-	-	S3TFU1818(S)	-	-
.018 x .025	G4TFU1825 (CB) (S)	G4TFM1825 (CB) (S)	G4TFS1825 (CB) (S)	-	-	-	S3TFU1825(S)	S3TFM1825 (S)	S3TFS1825 (S)
.019 x .025	G4TFU1925 (CB) (S)	G4TFM1925 (CB) (S)	G4TFS1925 (CB) (S)	B3TFU1925 (S)	B3TFM1925 (S)	B3TFS1925 (S)	S3TFU1925(S)	S3TFM1925 (S)	S3TFS1925 (S)
.020 x .020	G4TFU2020 (CB) (S)	G4TFM2020 (CB) (S)	G4TFS2020 (CB) (S)	-	-	-	S3TFU2020(S)	-	S3TFS2020 (S)
.021 x .025	G4TFU2125 (CB) (S)	G4TFM2125 (CB) (S)	G4TFS2125 (CB) (S)	B3TFU2125 (S)	B3TFM2125 (S)	B3TFS2125 (S)	S3TFU2125(S)	S3TFM2125 (S)	S3TFS2125 (S)

Bulk-Pack Kits - Europa™II and Trueform™I

Europa™II archform	Small Tooth Kit Includes		All Tooth Kit Includes	
	100% Archform	#Packages / Wires per pkg.	#Packages / Wires per pkg.	#Packages / Wires per pkg.
Small Tooth Kit - Bulk Pack				
With Stops #PPSTKTCB	G4* .018	0	1 / 25	
Without Stops #PPSTKT*	G4* .014x.025	0	1 / 25	
	G4* .018x.025	0	1 / 25	
All Tooth Kit - Bulk Pack				
With Stops #PPATKTCB	TitanMoly* .019x.025	0	2 / 10	
Without Stops #PPATKT	S304 .019x.025	0	1 / 25	
92% Archform				
	G4* .018	2 / 25	1 / 25	
	G4* .014x.025	2 / 25	1 / 25	
	G4* .018x.025	2 / 25	1 / 25	
	TitanMoly* .019x.025	4 / 10	2 / 10	
	S304 .019x.025	2 / 25	1 / 25	
84% Archform				
	G4* .018	1 / 25	1 / 25	
	G4* .014x.025	1 / 25	1 / 25	
	G4* .018x.025	1 / 25	1 / 25	
	TitanMoly* .019x.025	2 / 10	2 / 10	
	S304 .019x.025	1 / 25	1 / 25	
		Total Pkgs.: 18 / Wires: 360	Total Pkgs.: 18 / Wires: 360	

*G&H® Orthodontics is in no way affiliated with or endorsed by Ormco Corporation or Dr. Dwight Damon. **MBT is a trademark of 3M Unitek.
 **G&H® prescriptions are not implied to be an exact version of any other system, nor do we claim any endorsement by the doctor.

Solo-Pack™ Kits - Europa™II and Trueform™I

Europa™II archform	Small Tooth Kit Includes		All Tooth Kit Includes	
	100% Archform	#Packages / Wires per pkg.	#Packages / Wires per pkg.	#Packages / Wires per pkg.
Small Tooth Kit - Solo-Pack*				
With Stops #PPSTKTCB*	G4* .018	0	2 / 10	
Without Stops #PPSTKTS*	G4* .014x.025	0	2 / 10	
	G4* .018x.025	0	2 / 10	
All Tooth Kit - Solo-Pack*				
With Stops #PPATKTCB	TitanMoly* .019x.025	0	2 / 10	
Without Stops #PPATKTS	S304 .019x.025	0	2 / 10	
92% Archform				
	G4* .018	3 / 10	2 / 10	
	G4* .014x.025	3 / 10	2 / 10	
	G4* .018x.025	3 / 10	2 / 10	
	TitanMoly* .019x.025	3 / 10	2 / 10	
	S304 .019x.025	3 / 10	2 / 10	
84% Archform				
	G4* .018	2 / 10	1 / 10	
	G4* .014x.025	2 / 10	1 / 10	
	G4* .018x.025	2 / 10	1 / 10	
	TitanMoly* .019x.025	2 / 10	1 / 10	
	S304 .019x.025	2 / 10	1 / 10	
		Total Pkgs.: 25 / Wires: 250	Total Pkgs.: 25 / Wires: 250	

G4™ NiTi Closed Coil Springs

Precision Manufactured By G&H® Orthodontics



G4™ Nickel Titanium Springs

The unique G4™ Nickel Titanium alloy developed by G&H® is precision formed into closed coil springs. G4™ Springs provide consistent force and remain active until the space is closed. Consistent force values and full recovery are both achieved routinely with G4™ NiTi Springs.



G4™ Nickel Titanium Closed Coil Springs with Eyelets

Available with round eyelets on both ends (CC) or with one round and one TAD spring engagement eyelet (TAD). Packaged in convenient dispenser boxes, 10/box. See chart below for force values and part numbers.







Distinct Identification

CC and TAD Spring boxes sizes and force values are clear and accurate at chairside. Color coded ID markings on boxes simplify selection of correct spring. Easy to dispense and reseal.

(Passive Spring Length) Length	Size	(Force Rating) Force	(10 springs/box) Order Numbers	Extension Measurement Landmarks (mm) / Subsequent Force Values (gms)					
				11mm	14mm	17mm	21mm	28mm	36mm
 (Pictured Actual Size)	9F	Feather Light (50g)	CCOF9FL	30	35	40	50*	X	X
	9X	Extra Light (100g)	CCOF9XL	60	70	80	100*	X	X
	9L	Light (150g)	CCOF9LT	95	115	130	150*	X	X
	9M	Medium (200g)	CCOF9MD	120	145	165	200*	X	X
	9H	Heavy (250g)	CCOF9HV	135	175	210	250*	X	X
 (Pictured Actual Size)	12F	Feather Light (50g)	CCOF12FL	X	30	32	35	40	50*
	12X	Extra Light (100g)	CCOF12XL	X	60	65	70	80	100*
	12L	Light (150g)	CCOF12LT	X	95	100	115	130	150*
	12M	Medium (200g)	CCOF12MD	X	120	130	145	165	200*
	12H	Heavy (250g)	CCOF12HV	X	135	150	175	210	250*

*Indicates maximum overall extension for the respective spring length. Extending springs beyond the suggested maximum can cause permanent deformation and distort applied force values. Note: Force Values listed apply only to G4™ OrthoForce™ Springs from G&H® Orthodontics. G&H® and OrthoForce™ are registered trademarks of G&H® Wire Company, Inc. ©2017 G&H® Orthodontics

(Passive Length) Length	SIZE	(Force Rating) Force	(10 springs/box) Order Numbers	Extension Measurement Landmarks (mm) / Subsequent Force Values (gms)									
				13mm	15mm	17mm	19mm	22mm	27mm	31mm	36mm	41mm	
 A Extra Short (11mm)	A1	Light (150g)	CCOT45LT	95	125	150*	X	X	X	X	X	X	
	A2	Medium (200g)	CCOT45MD	130	170	200*	X	X	X	X	X	X	
	A3	Heavy (250g)	CCOT45HV	150	210	250*	X	X	X	X	X	X	
 B Short (13mm)	B1	Light (150g)	CCOT6LT	X	95	120	130	150*	X	X	X	X	
	B2	Medium (200g)	CCOT6MD	X	125	150	170	200*	X	X	X	X	
	B3	Heavy (250g)	CCOT6HV	X	150	180	200	250*	X	X	X	X	
 C Medium (15mm)	C1	Light (150g)	CCOT9LT	X	X	85	100	110	130	150*	X	X	
	C2	Medium (200g)	CCOT9MD	X	X	115	140	150	180	200*	X	X	
	C3	Heavy (250g)	CCOT9HV	X	X	145	165	175	220	250*	X	X	
 D Long (17mm)	D1	Light (150g)	CCOT12LT	X	X	X	85	95	110	120	130	150*	
	D2	Medium (200g)	CCOT12MD	X	X	X	110	125	150	170	190	200*	
	D3	Heavy (250g)	CCOT12HV	X	X	X	130	150	175	200	230	250*	

(Springs shown actual size)

*Indicates maximum overall extension for the respective spring length. Extending springs beyond the suggested maximum can cause permanent deformation and distort applied force values. Note: Force Values listed apply only to G4™ OrthoForce™ Springs from G&H® Wire Company. G&H® and OrthoForce™ are registered trademarks of G&H® Wire Company, Inc. ©2017 G&H® Wire Company, Inc.

Closed Coil Springs are also available in a G&H® exclusive comprehensive kit to provide forces as prescribed.



(CC) Spring - 150 Gram Kit

Weighted kit featuring all necessary CC Springs for 150gm load applications. No matter what the extension, the kit contains the spring to apply 150gms. Kit includes 12 boxes of springs, (sizes may be altered if desired) 3 boxes of 9M, 9H, 2 boxes of 9L, 12L, 12M, 1 box of measuring gauges, inventory kit box and laminated force chart. Kit box keeps inventory neat and secure. Laminated heavy-duty design for extended use. Convenient and functional.

KTCCOF150



(TAD) Spring - 200 Gram Kit

Weighted kit featuring all necessary TAD Springs for 200gm load applications. No matter what the extension, the kit contains the spring to apply 200gms. Kit includes 12 boxes of springs, (sizes may be altered if desired) 3 boxes of A2, 2 of A3, B2, B3, 1 of C2, C3, D2, 1 box of measuring gauges, inventory kit box and laminated force chart. Kit box keeps inventory neat and secure. Laminated heavy-duty design for extended use. Convenient and functional.

KTCCOT200

G4™ NiTi Coil Springs

Precision Manufactured By G&H® Orthodontics

G4™ NiTi Closed Coil Springs deliver ideal forces for Class II intra-arch maxillary retraction as well as other space closure and maintenance applications. .030" I.D. coil diameter - 21" spool



	Force	21" Spool
Ultra Light	100 gm	CCNT21075
Light	150 gm	CCNT21150
Medium	200 gm	CCNT21200
Heavy	250 gm	CCNT21250

G4™ NiTi Open Coil Springs open and maintain space gently and efficiently in a convenient cut to length design. Three 7" lengths per package or convenient 21" spool.

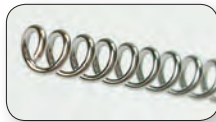

Open Coil Springs	Wire size	I.D.	Force	Force when	Force when	7" Straight	21" Spooled
				compressed	compressed		
				25% (.250")	50% (.500")		
				(Force in grams)	(Force in grams)		
	.009"	.030	Ex-Light	95	225	OCNT09307	OCNT093021
	.010"	.030	Light	120	260	OCNT10307	OCNT103021
	.010"	.036	Med-Light	90	200	OCNT10367	OCNT103621
	.012"	.030	Medium	220	480	OCNT12307	OCNT123021
	.012"	.036	Medium-Hvy	180	380	OCNT12367	OCNT123621
	.014"	.030	Heavy	360	700	OCNT14307	OCNT143021
	.014"	.036	Ex-Heavy	270	560	OCNT14367	OCNT143621
	.010"	.045	Facebow	55	120	OCNT10457	OCNT104521

Force determined by compressing a 1" open coil spring 25% (0.250") and 50% (0.500") and capturing the resulting force in grams.

G4™ NiTi Open Coil Springs sized in 15mm lengths designed for opening spaces up to 15mm. 10/box

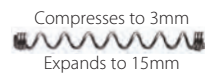

I.D.	Force		
.036	100gm	Light	OCNT15100
.036	150gm	Medium	OCNT15150
.036	200gm	Heavy	OCNT15200



G4™ NiTi Molar Distalizing Open Coil Springs

deliver gentle 100 grams of force to achieve average 1mm to 1.5mm distalization per month without patient cooperation. Place over archwire and anchor with stop hook and elastics or Nance Appliance for maximum effectiveness. Intermittent closed coil sections allow for end stops when cut to length. .045" I.D. Three 7" lengths per pack, or 21" spool.

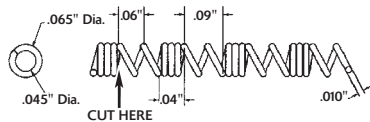

7" Lengths	OCNT7045
21" Spool	OCNT2145

Note: Open and Closed Coil Springs with an .030" I.D. helix can be engaged over G&H® wires up to and including .019" x .025".

Niti Separating (NEET) Springs

offer efficient force for separating contact points prior to banding. Simple engagement and self activating.

.018" wire diameter, 20/pkg.

Bicuspid (Small)	NEETSM20
Molar (Large)	NEETLG20



Stainless Steel Coil Springs

Precision Manufactured By G&H® Orthodontics

Stainless steel open and closed coil springs are available on 21" spools.



Stainless Steel Open Coil Springs

.010x.028	SSOC1028
.010x.030	SSOC1030
.010x.036	SSOC1036

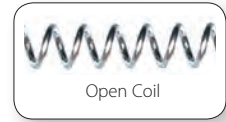

Open Coil

Stainless Steel Closed Coil Springs

.010x.030	SSCC1030
-----------	-----------------



Closed Coil

From clinical supplies to patient products,



G&H offers a full line of quality orthodontic products.

View and order our full line at:

GHOrthodontics.com

Crimpable Micro-Stops

Use as an anchor to limit tooth movement. Thread wire through micro-stop, then crimp with any holding plier. Annealed to crimp evenly and securely.
2mm long – 50/pack

Small .012" to .018"
Large .020" to .020"x.020"

CSTOPSM
CSTOPLG



Crimpable Stops

Maintain wire positioning or limit tooth movement. Open wall, MIM crimpable stop fits round or rectangular wires .018" to .021"x.025". Annealed to crimp evenly and securely.

2mm long – 10/box

CSTOPOW



Auxiliary Force Products

Palatal Arch Bars are formed in .036" stainless with double back bends for arch maintenance, molar rotation and distalization.

5/pkg. (Kits contain - 5 each of sizes 34, 36, 38, 40, 46, 52mm and 10 each of sizes 42 and 44mm, 50 pieces total).

	Mesial Loop	Distal Loop
34mm	PAB34	PAB134
36mm	PAB36	PAB136
38mm	PAB38	PAB138
40mm	PAB40	PAB140
42mm	PAB42	PAB142
44mm	PAB44	PAB144
46mm	PAB46	PAB146
52mm	PAB52	PAB152



KIT **PABK050** **PABK150**



Looking for clinical supplies?

You'll find what you need in our full line of quality products!

From lab supplies to clinical treatment products, G&H offers more than 6,000 brand-name items and precision G&H manufactured products.

Order online at: GHOrthodontics.com

Crimpable Hooks

Surgical & Arch Hooks are cast for durability and reliable performance. 10/pkg.

Surgical Hooks with 1.25mm ball • 10/pack

	Fits up to .018 x .025	.022 x .028
Slide-On	SURHK620C	SURHK621C
Open-Wall (Universal)	SURHK	

Arch Hooks with .75mm ball • 10/pack

	Fits up to .018 x .025	.022 x .028
Slide-On	ARHK632C	ARHK633C
Open-Wall, Right	ARHK630CR	ARHK631CR
Open-Wall, Left	ARHK630CL	ARHK631CL

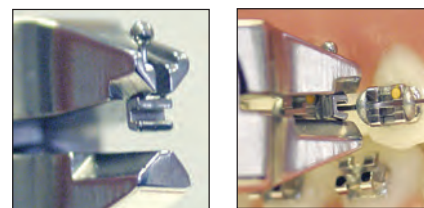
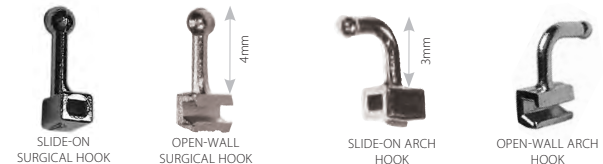

See page 120 for hook crimping pliers.

SEE ALL PLIERS BEGINNING ON PAGE 119

Slide-On Vertical Tube

New tube design which slides on a wire and has a second auxiliary tube positioned vertically. The .020x.020 vertical tube accepts auxiliaries like hooks. 20/Box

.017x.025 Red I.D. mark **V-T1725**
.019x.025 Black I.D. mark **V-T1925**



Slide V-Tube on Archwire

Shepherd Hooks

2 designs - One hook is 4mm high and the other is a double with heights of both 2mm and 6mm. 20/Box

4mm
2, 6mm

SHPHK4
SHPHK6



Stainless Steel "T" Hooks

Fit all V-Slot brackets, for elastics where needed.

50/pkg.

THK050



Pre-Bent/Straight

Rapid Palatal Expanders

Leone™ designed and manufactured in Italy. Renowned for their precision and durability, these palatal expanders are among the finest available. Expanders Include (1) Straight & Bent Key and Leash/pkg. (Also available separately)



Expabent

- Pre-Bent 8mm
Body Length 12mm **2000/8**
- Pre-Bent 9mm
Body Length 14mm **2000/9**
- Pre-Bent 11mm
Body Length 15mm **2000/11**



Palatal Suture Splitting and Expansion

- Straight 8mm **PALEXP008**
- Straight 9mm **PALEXP009**
- Straight 11mm **PALEXP011**
- Straight 13mm **PALEXP013**

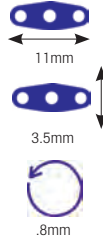

Exspider (fan type)

- 9mm **A0625-09**







Torko

- 8mm 36mm arms **A0623-08**
- 8mm 62mm arms **X0022**
- 11mm 36mm arms **A0623-11**
- 11mm 62mm arms **X0023**

Expansion Screws

Expansion Screws are precision made in Germany and available in a variety of styles for various applications. Stainless steel bodies and threads are extremely strong, and the mechanical design minimizes the potential for back-turning.

5/pkg. - Includes 5 small hand keys

			
ESCR001 7.5mm	ESCR002 5mm	ESCR003 5mm	ESCR004 5mm
APPLICATION Upper & Lower Midline		U-Shape Guide Pin for sectional expansion, arch lengthening and individual tooth movement.	
MM SIZE 14x10x3.15		12x7.5x3.5	13x6x3.2 13x7.5x3.5



Swivel Safety Activation Keys

Features secure-grip handle and offset insertion tip to prevent over-seating in screws. The swivel safety key is highly recommended for use with all expansion screws.

10/pkg. **EXPKY10**

- A) Straight Key - 100/pkg. **A0557-00**
- B) 45° Angle Key - 100/pkg. **A0557-01**
- C) Safety Leash - 100/pkg. **A0557-02**

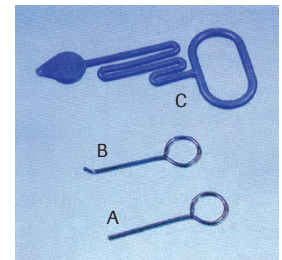

G&H offers a full line of quality orthodontic products - precision engineered and made in the U.S.A.

*View and order our full line at:
GHOrthodontics.com*

Elastomeric Products



Engineered to exacting standards to ensure consistent force delivery.

TOP SELLER!

Latex-Free

Versa-Ties™

Our Versa-Tie™ elastomeric ligatures are designed to maximize clinical functionality and treatment efficiency.

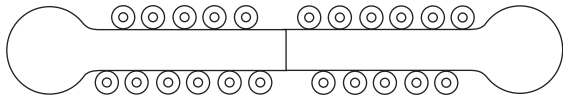

Illustration actual size

- Optimum size ties** – .120 diameter
- Engage with a firm feel** – facilitate tooth movement & retention
- Score line** – allows easy conversion to half-sticks – avoids waste and cross-contamination
- Patient specific** – 22 ties per stick
- Etched thumb tabs** – for secure grip with gloves
- Colors coordinate with Dyna-Link™ Chain**

22 ties per stick - 46 sticks per package - 1,012 ties total
 Colors and order numbers listed on next page.
 (Actual product colors may vary slightly)

TOP SELLER!

Latex-Free

Bambino-Ties™

Unique handle facilitates multi-color applications.

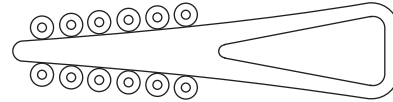

Illustration actual size



- Optimum size ties** – .120 diameter
- 12 ties per stick** – eliminates waste and cross-contamination
- Elasticity and recovery** – allow retention to any size bracket
- Soft feel** – positive engagement
- Hold securely** – or wear on fingers for ease of engagement and multi-color application
- Colors coordinate with Dyna-Link™ Chain**

12 ties per stick - 84 sticks per package - 1,008 ties total
 Colors and order numbers listed on next page.
 (Actual product colors may vary slightly)



Multi-Color Packs Versa-Tie™ and Bambino-Tie™ Elastomeric Ligature Ties

Three different multi-color packages of 46 Versa-Tie™ or 84 Bambino™ sticks are now available from G&H®. See what colors your patients prefer!

NOTE: Clear, Gray, and Metallic Silver are not included in Multi-Color packs.



Vibrant Pack Includes: Pearl, Glow, Neon Green, Pearl Green, Glow Blue, Pearl Blue, Lavender, Maroon

Bambino™ - **BTVP84**
Versa-Tie™ - **VTVP46**



Assorted Pack Includes: Black, Light Sky Blue, Green, Royal Blue, Ruby Red, Orange, and Metallic Purple

Bambino™ - **BTAS84**
Versa-Tie™ - **VTAS46**



Rainbow Pack Includes: Metallic Gold, Metallic Red, Yellow, Metallic Blue, Deep Sky Blue, Fuchsia, Dark Transparent Green, Turquoise

Bambino™ - **BTRP84**
Versa-Tie™ - **VTRP46**

Latex-Free

Mini-Ties

The same clinical attributes as our standard Versa-Tie™ elastomeric ligature ties only in a convenient half-stick.

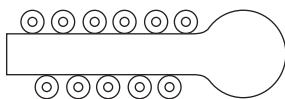

Illustration Actual Size



- Optimum size ties** – .120 diameter
- Engage with a firm feel** – facilitate tooth movement & retention
- 11 Ties per stick** – avoids waste and cross-contamination
- Patient specific** – 11 ties per stick
- Etched thumb tab** – for secure grip with gloves
- Colors coordinate with Dyna-Link™ Chain**

11 ties per stick - 92 sticks per package - 1,012 ties total
 Colors and order numbers listed on next page.
 (Actual product colors may vary slightly)

Latex-Free

Select-Ties

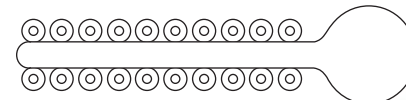

Illustration Actual Size









- Optimum size ties** – .120 diameter
- 20 ties per stick** – eliminates waste and cross-contamination
- Elasticity and recovery** – allow retention to any size bracket
- Soft feel** – positive engagement
- Colors coordinate with Dyna-Link™ Chain**

20 ties per stick - 50 sticks per package - 1,000 ties total
 Colors and order numbers listed on next page.
 (Actual product colors may vary slightly)

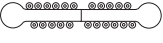
Color Chart For Elastomeric Ties & Chain

CLEAR	GLOW	PEARL	METALLIC RED	RUBY RED	ORANGE
WHITE	GLOW BLUE	PEARL GREEN	METALLIC GOLD	MAROON	FLUORESCENT ORANGE
BLACK	TOOTH	PEARL BLUE	METALLIC PURPLE	LAVENDER	FUCHSIA
GRAY	NEON GREEN	GREEN	TRANSPARENT GREEN	TURQUOISE	PINK
SMOKE	DEEP SKY BLUE	NAVY BLUE	METALLIC BLUE	ROYAL BLUE	FLUORESCENT PINK
METALLIC SILVER	LIGHT SKY BLUE	YELLOW			

Order Numbers For Elastomeric Ties & Chain

	Versa-Tie™	Bambino-Tie™	Mini-Tie	Select-Tie	Dyna-Link™ Chain		
							
					Continuous	Short	Long
Pearl	VTPL46	BTPL84	OCMPL	OCSLPL	CDLPL	SDLPL	LDLPL
Glow	VTGW46	BTGW84	OCMGL	OCSLGL	CDLGW	SDLGW	LDLGW
Neon Green	VTNG46	BTNG84	OCMNG	OCSLNG	CDLNG	SDLNG	LDLNG
Pearl Green	VTPG46	BTPG84	OCMPG	OCSLPG	CDLPG	SDLPG	LDLPG
Glow Blue	VTGB46	BTGB84	OCMGB	OCSLGB	CDLGB	SDLGB	LDLGB
Pearl Blue	VTPB46	BTPB84	OCMPB	OCSLPB	CDLPB	SDLPB	LDLPB
Lavender	VTLV46	BTLV84	OCMLV	OCSLLV	CDLLV	SDLV	LDLV
Maroon	VTMA46	BTMA84	OCMMA	OCSLMA	CDLMA	SDLMA	LDLMA
Clear	VTCL46	BTCL84	OCMCL	OCSLCL	CDLCL1	SDLCL1	LDLCL1
Gray	VTGY46	BTGY84	OCMGY	OCSLGY	CDLGY	SDLGY	LDLGY
Metallic Silver	VTSV46	BTSV84	OCMMS	OCSLMS	CDLSV	SDLV	LDLSV
Metallic Gold	VTGD46	BTGD84	OCMGD	OCSLGD	CDLGD	SDLGD	LDLGD
Metallic Purple	VTPP46	BTPP84	OCMPP	OCSLPP	CDLPP	SDLPP	LDLPP
Metallic Red	VTMR46	BTMR84	OCMMR	OCSLMR	CDLMR	SDLMR	LDLMR
Metallic Blue	VTMB46	BTMB84	OCMMB	OCSLMB	CDLMB	SDLMB	LDLMB
Royal Blue	VTRB46	BTRB84	OCMRB	OCSLRB	CDLRB	SDLRB	LDLRB
Lt. Sky Blue	VTLS46	BTLS84	OCMLS	OCSLLS	CDLLS	SDLLS	LDLLS
Deep Sky Blue	VTDS46	BTDS84	OCMDS	OCSLDS	CDLDS	SDLDS	LDLDS
Navy Blue	VTNB46	BTNB84	OCMNB	OCSLNB	CDLNB	SDLNB	LDLNB
Green	VTGR46	BTGR84	OCMGR	OCSLGR	CDLGR	SDLGR	LDLGR
Transp. Green	VTTG46	BTTG84	OCMTG	OCSLTG	CDLTG	SDLTG	LDLTG
Ruby Red	VTRR46	BTRR84	OCMRR	OCSLRR	CDLRR	SDLRR	LDLRR
Turquoise	VTTQ46	BTTQ84	OCMTQ	OCSLTQ	CDLTQ	SDLTQ	LDLTQ
White	VTWT46	BTWT84	OCMWT	OCSLWT	CDLWT	SDLWT	LDLWT
Fuchsia	VTFU46	BTFU84	OCMFU	OCSLFU	CDLFU	SDLFU	LDLFU
Black	VTBK46	BTBK84	OCMBK	OCSLBK	CDLBK	SDLBK	LDLBK
Orange	VTOR46	BTOR84	OCMOR	OCSLOR	CDLOR	SDLOR	LDLOR
Fluor. Orange	VTFO46	BTFO84	OCMFO	OCSLFO	CDLFO	SDLFO	LDLFO
Yellow	VTYW46	BTYW84	OCMYW	OCSLYW	CDLYW	SDLYW	LDLYW
Pink	VTPK46	BTPK84	OCMPK	OCSLPK	CDLPK	SDLPK	LDLPK
Fluor. Pink	VTFP46	BTFP84	OCMFP	OCSLFP	CDLFP	SDLFP	LDLFP
Tooth	VTTC46	BTTC84	OCMTC	OCSLTC	CDLTC	SDLTC	LDLTC
Smoke	VTSM46	BTSM84	OCMSM	OCSLSM	CDLSM	SDLSM	LDLSM

METAL LIGATURE TIES AVAILABLE ON PAGE 76

MATHIEU HEMOSTAT AVAILABLE ON PAGE 122

Companion Product



Elastomeric Ligature Color Display Booklet

Conveniently displays 33 elastomeric ligature tie colors for easy patient or clinician selection. Rotate color wheel to see how colors look together. Also shows all ligature tie part numbers for easy ordering/reordering. Measures 7½"x8½" when folded.

Ea. **LIGTIEBOOK**

Ligature ties as unique as kids! - Exclusively from G&H

DESIGNER ties



Let your patients choose **A FUN NEW SMILE!**

Designs and colors for the ultimate in self-expression every time they smile. DesignerTies® are the best way to make a fashion statement with your patients' braces. Incredible marketing tool that gets patients excited about braces!

ATTRACT NEW PATIENTS!

- Increase patient engagement
- Greater incentive for patients to make appointments
- Differentiate your practice
- Made in the U.S.A.
- No special equipment for placement
- No interference with traditional mechanics, little or no added friction
- Seasonal shapes and colors!



Promote DesignerTies® in your patient waiting area!

Each starter kit includes:

- (1) 20pk of Red Hearts
- (1) 20pk of Blue Stars
- (1) 20pk of Purple Flowers
- (1) 20pk of Yellow Smiley Faces
- (1) DesignerTies® chairside key ring for easy patient selecting
- (2) 8.5"x11" DesignerTies® easel display posters/pamphlet holder
- (25) tri-fold pamphlets



Starter kit order number: **DTIEKIT**

See the application video and instructions on our website – GHOrthodontics.com/DesignerTies



INDIVIDUAL DESIGNERTIES® - PATIENT PLEASING COLORS AND STYLES!

CLASSIC SHAPES			HOLIDAY / SEASONAL		SPORTS			
Star Red DTIE-10	Star White DTIE-09	Star Blue DTIE-02	Tree Green DTIE-07	Stocking Red DTIE-06	Soccer Ball Red DTIE-21	Soccer Ball Orange DTIE-17	Soccer Ball Light Sky Blue DTIE-23	Soccer Ball Metallic Silver DTIE-20
Heart Red DTIE-01	Heart Purple DTIE-12	Heart Pink DTIE-14	Jack O' Lantern Orange DTIE-15	Ghost Metallic Silver DTIE-18	Football Helmet Light Sky Blue DTIE-24	Football Helmet Red DTIE-22	Football Helmet Orange DTIE-16	Football Helmet Metallic Silver DTIE-19
Flower Pink DTIE-13	Flower Purple DTIE-03	Smiley Face Yellow DTIE-04	Snowflake White DTIE-05	Shamrock Green DTIE-08				

Each shape available in packs of 20 sticks, 10 ties per stick, 200 ties total.

New shapes and colors coming soon!

TOP SELLER!

Latex-Free

Dyna-Link™ Elastomeric Chain

Dyna-Link chain offers superior memory and durability characteristics with excellent color stability and stain resistance. G&H® precision engineers each style of Dyna-Link™ to exacting standards to ensure consistent force delivery with minimal decay rates.

.026" thick



33 colors to choose from!

Dyna-Link™ Elastomeric Chain is precision manufactured and scientifically tested by G&H® to ensure:

- Continuous, gentle force for predictable tooth movement
- High elasticity with superior memory and rebound
- Excellent color stability
- 3 spacing variations between links
- .026" thickness
- 15 ft. spool
- Colors coordinate with Bambino-Ties™, Versa-Ties™, Select-Ties & Mini-Ties.

Colors and Order Numbers listed on previous page. (Actual product colors may vary slightly)

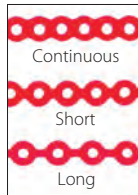

Actual size



Looking for elastics and ligature ties?

You'll find what you need in our full line of quality products!

From lab supplies to clinical treatment products, G&H offers more than 6,000 brand-name items and precision G&H manufactured products.

Order online at: GHOrthodontics.com

Latex-Free

Slim-Chain™ Elastomeric Chain

G&H®'s new **Slim-Chain™** is a thin version for increased comfort and also to accommodate lingual treatment mechanics. Only .018" in thickness, this chain has a low profile along with the elasticity and recovery needed for effective movement.

Only .018" thick



- Low profile - great for lingual treatment and comfort
- Thinner chain - easier to ligate under tie wings / self-ligating brackets
- Superb resiliency & memory
- 15 ft. spool

3 Colors Available -

CLEAR	PEARL	MET. SILVER
Clear Slim-Chain™	Pearl Slim-Chain™	Silver Slim-Chain™
Continuous - CDLCLT	Continuous - CDLPLT	Continuous - CDLSVT
Short - SDLCLT	Short - SDLPLT	Short - SDLSVT
Long - LDCLT	Long - LDPLT	Long - LDLSVT



Available In Clear, Pearl & Silver

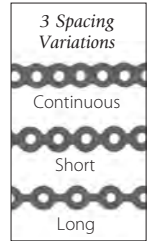

Actual size

Elastomeric Chain Dispenser

Our chain dispenser features a lid that encloses the spools to prevent inadvertent contamination. Stores twelve spools. Measures 3" wide x 8 1/8" long x 3 1/8" high. Made of anodized aluminum with a brushed finish.

Ea.

CHDSA700

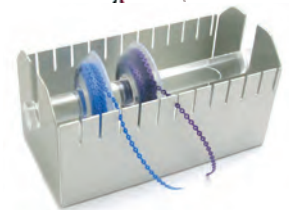

Inside view

Elastomeric Chain Dispenser

Holds up to 18 spools of 15 ft. chain. Measures 9 7/8" L x 3 7/8" D x 4 1/4" H. White acrylic with clear lid.

Ea.

1016

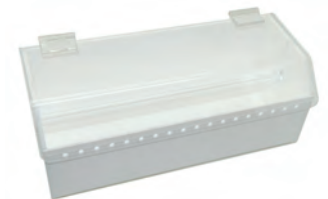

PowerLinx™ Chain - Latex-Free



A biomaterial breakthrough in elastic chain

G&H® Orthodontics' "PowerLinx™" chain is produced from a unique and proprietary blend of thermoset polymers. Thermoset polymers molecular stability produces increased elasticity and resiliency that retain forces for extended periods of time.

Documented scientific research proves PowerLinx™ can endure higher stresses longer with minimal force degradation (see graph below). The recovery force of PowerLinx™ remains elevated and active over a longer timeframe than traditional chain. The result is that PowerLinx™ produces more effective and tenacious forces for facilitating tooth movement.

Each spool contains 2 meters (6.56 ft.) .020" thickness.

Short Clear
Short Gray
Long Clear
Long Gray

SPLCL
SPLGY
LPLCL
LPLGY

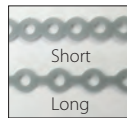

Deformation Comparison

Plastic chain (photos actual size)



PowerLinx™ chain (photos actual size)



PowerLinx™ Chain retains up to 85% of its original pull strength even after 6 weeks of engagement.

G&H Dyna-Link™ chain is consistent in strength and force values and available in 33 colors. (see page 92)



Elastic Power Thread

Medical grade elastomers precisely extruded for use in rotations and retraction applications. Hollow thread compresses to minimize slippage when knotted. Latex-free.

Ea.



Thread, Solid (50 ft. spool)	.025"	.030"
Grey	ETGY025	ETGY030
Clear	ETCL025	ETCL030

Thread, Slip-Not, Solid (25 ft. spool)	.025"	.030"
Grey	SNTGY025	SNTGY030
Clear	SNTCL025	SNTCL030

Thread, Hollow (50 ft. spool)	.025"	.030"
Grey	TBGY025	TBGY030
Clear	TBCL025	TBCL030

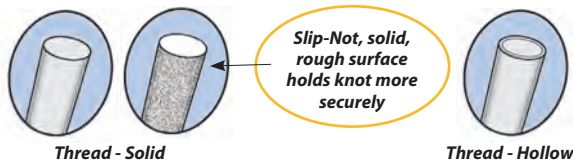

Archwire Sleeve Protective Tubing

Slides over wire to reduce irritation and maintains space where desired. Ideal for extraction site maintenance. Latex-free.

10 ft. per spool.

Archwire Sleeve	.018"	.027"	.046"
Fits up to:	.018" Round	.021"x.027"	.046" Round
Grey	ASPTG018	ASPTG027	ASPTG046
Clear	ASPTC018	ASPTC027	ASPTC046

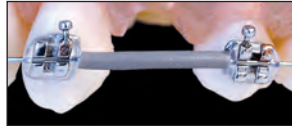

Clinical Tip:
To engage tubing on full size wires, apply a drop of alcohol to act as a lubricant.

Safe-Seps Elastomeric Separators

960/pkg. Latex-free

Heavy - Purple **500-003**
Regular - Blue **500-004**



Molded Elastomeric Separators

.180" diameter, latex-free.

960/pkg. **500-001**



Radiopaque Elastomeric Separators

These separators are easily identified on x-ray and offer high resiliency for dependable separation quickly and efficiently. Medium blue color. 1,000/pkg. Latex-free

Small - 0.155" O.D., 0.042" thick **325-302**
Large - 0.193" O.D., 0.049" thick **325-303**



SEPARATOR PLIER
ON PAGE 123

Pre-loaded Canes

Available in 2 sizes and in grey or clear. Pre-loaded canes have 50 ligatures each with 20 canes per pack (1,000 total pieces). Bulk packs of 5,000 loose ligatures per pouch. Latex-free

Ea.



Pre-Loaded Canes and Bulk Ligatures

	.110		.120	
	Cane	Bulk	Cane	Bulk
Grey	CGY10	BGY10	CGY20	BGY20
Clear	CCL10	BCL10	CCL20	BCL20

Rotation Wedges

Rotation wedges fit beneath the archwire to administer rotation forces where desired. Latex-free

100/pkg.

Clear **RWPCL100**
Grey **RWPGY100**



Non-Latex Elastics

Non-Latex Elastics are ideal for avoiding patient sensitivity to latex. Manufactured of a unique polymer which eliminates the protein and other potential allergy reacting compounds associated with latex. Pouches contain 100 patient packs of 100 elastics.

Available in Natural Color only.

size	4.5 oz. medium
3/16" (Blue label)	LFM36
1/4" (Green label)	LFM14





- Manufactured from the highest quality surgical grade latex
- Each patient pack is color-coded and individualized with its own Extreme Sport
- Force levels guaranteed consistent every time
- Each carton contains 50 patient packs - 100 elastics per pack



ELASTIC PLACEMENT TOOL AVAILABLE ON PAGE 165

	1/8" (3.2mm)	3/16" (4.8mm)	1/4" (6.4mm)	5/16" (7.9mm)	3/8" (9.5mm)
LIGHT 3.5 oz.	M931-01	M931-02	M931-03	M931-04	M931-05
MEDIUM 4.5 oz.	M931-06	M931-07	M931-08	M931-09	M931-10
HEAVY 6.0 oz.	M931-11	M931-12	M931-13	M931-14	M931-15

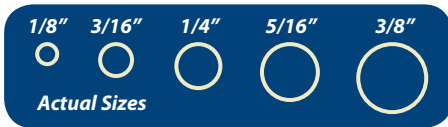

LIGHT Force Level

<p>1/8" (3.2mm)</p> <p>Kayaking</p>	<p>3/16" (4.8mm)</p> <p>Motorcross</p>	<p>1/4" (6.4mm)</p> <p>Rock Climbing</p>	<p>5/16" (7.9mm)</p> <p>Skateboarding</p>	<p>3/8" (9.5mm)</p> <p>Water Skiing</p>
-------------------------------------	--	--	---	---

MEDIUM Force Level

<p>1/8" (3.2mm)</p> <p>Surfing</p>	<p>3/16" (4.8mm)</p> <p>Skiing</p>	<p>1/4" (6.4mm)</p> <p>Skydiving</p>	<p>5/16" (7.9mm)</p> <p>BMX Freestyle</p>	<p>3/8" (9.5mm)</p> <p>Wind Surfing</p>
------------------------------------	------------------------------------	--------------------------------------	---	---

HEAVY Force Level

<p>1/8" (3.2mm)</p> <p>Jet Skiing</p>	<p>3/16" (4.8mm)</p> <p>Bungee Jumping</p>	<p>1/4" (6.4mm)</p> <p>Snowmobiling</p>	<p>5/16" (7.9mm)</p> <p>Snowboarding</p>	<p>3/8" (9.5mm)</p> <p>Wakeboarding</p>
---------------------------------------	--	---	--	---

*Force ratings based on elastic being extended three times the listed diameter.

Enchanted™ Series Latex Elastics

All **G&H® Enchanted™ Series Latex Elastics** are packaged for quick and unique identification. G&H® manufactures amber and assorted color elastics from the finest surgical grade natural latex rubber to ensure reliable force delivery. Elastics are pre-packed in color coded Enchanted™ Patient Packs of 100 elastics and are dispensed from Enchanted™ Cartons—50 patient packs per box (5,000 total elastics).

Each patient pack includes an elastics placement tool.

ELASTIC PLACEMENT TOOL AVAILABLE ON PAGE 165





















- Patient Pack Dispenser Box**
- I.D. label clearly identifies elastics
 - Laminated cardboard construction & colorful artwork compliments operator
 - Holds 50 patient packs
 - Resists moisture
 - Ensures fresh elastics - dry, clean storage
 - Dispenser box stands on counter or fits in a convenient wall dispenser
 - Patient-friendly easy to grab patient packs



Dispenser for Carton Elastics dispenses up to four cartons of elastics. Recommended for use with Enchanted™ Series Elastics. Anodized aluminum.
Ea. **ELDS400**

Dimensions: 3" deep x 12 1/4" long x 10" high

1/8" (3.2mm) ORANGE (TEXT) BAG	3/16" (4.8mm) BLUE (TEXT) BAG	1/4" (6.4mm) GREEN (TEXT) BAG	5/16" (7.9mm) RED (TEXT) BAG	3/8" (9.5mm) PURPLE (TEXT) BAG
LIGHT 2.5 oz. (70,88g) Leprechaun Amber 18LTAM Color N/A 	LIGHT 2.5 oz. (70,88g) Frog Prince Amber 36LTAM Color N/A 	LIGHT 2.5 oz. (70,88g) Giant Amber 14LTAM Color N/A 	LIGHT 2.5 oz. (70,88g) Centaur Amber 56LTAM Color N/A 	LIGHT 2.5 oz. (70,88g) Pirate Amber 38LTAM Color N/A 
MEDIUM 4.5 oz. (127,58g) Dragon Amber 18MDAM Color 18MDAC 	MEDIUM 4.5 oz. (127,58g) Genie Amber 36MDAM Color 36MDAC 	MEDIUM 4.5 oz. (127,58g) Sprite Amber 14MDAM Color 14MDAC 	MEDIUM 4.5 oz. (127,58g) Trumpeter Amber 56MDAM Color 56MDAC 	MEDIUM 4.5 oz. (127,58g) Barbarian Amber 38MDAM Color N/A 
HEAVY 6.5 oz. (184,28g) Wizard Amber 18HVAM Color 18HVAC 	HEAVY 6.5 oz. (184,28g) Unicorn Amber 36HVAM Color 36HVAC 	HEAVY 6.5 oz. (184,28g) Pegasus Amber 14HVAM Color 14HVAC 	HEAVY 6.5 oz. (184,28g) Knight Amber 56HVAM Color 56HVAC 	HEAVY 6.5 oz. (184,28g) Roman Soldier Amber 38HVAM Color N/A 
EX. HEAVY 8.5 oz. (240,98g) Gnome Amber 36XHAM Color N/A 	EX. HEAVY 8.5 oz. (240,98g) Minotaur Amber 14XHAM Color N/A 	EX. HEAVY 8.5 oz. (240,98g) Jester Amber 56XHAM Color N/A 		

1/2" Extraoral Latex Elastics

Available in bulk pouches of 1,000 elastics, natural latex and amber color only. 1,000/pkg. 8 oz. **AX012B**
16 oz. **AXH12B**

Manufacturing G&H® Elastics

The quality of Orthodontic elastics varies greatly depending on the manufacturer. Elastics manufacturers face significant challenges in controlling quality as massive quantities are produced. G&H® Orthodontics is a precision manufacturer of elastics and understands the importance of consistent force values. G&H® has developed manufacturing processes which include in-process testing and recalibration to ensure the elastics we supply meet the stringent force value tolerances you require.



Fresh Latex – G&H® uses only Surgical Class I Grade natural latex with exacting I.D. and O.D. tolerances. Weekly shipments of tubing ensure fresh latex for maximum performance elastics.



G&H® precision cutter blades are recalibrated and sharpened frequently. Elastics are precision cut to force value. Clean-cut edges ensure consistent expansion and force.



G&H® calibrated load cell testing regularly during production ensures exact and consistent force values. Elastics are tested at the industry standard expansion of 3 times passive diameter. Elastic samples are visually inspected and quality checked.

PRIVATE LOGO ELASTICS

Simple, FREE promotion for your practice!

Your patients know you,
and so will their friends.



Let your patients
advertise for you -

- Studying
- Lunchroom
- Sports



PRIVATE LOGO SERIES ELASTICS

Your practice logo and contact information printed on patient packs! Each private logo series latex elastic carton contains 50 patient packs of 100 elastics. (5,000 Elastics)

See our website or call to get started!

Five box minimum purchase per order, per elastic size and force value.



- Clear and simple sizing:
Color = Force, Letter = Dimension
- Available in the most popular sizes:
1/8", 3/16", 1/4", 5/16" – Medium and Heavy
(Other sizes available without Private Logo packaging)
- 50 patient packs of 100 elastics per carton (5,000 elastics)
- Natural Amber or Neon elastics available
- 3 year shelf-life on all elastics
- Made in the U.S.A. by G&H®

Clinical Supplies



G&H offers a complete line of clinical, bonding and lab supplies.

Aligner Support Products

Essix®

Plastics

G&H® carries a wide variety of Essix® plastics for your aligner and retainer needs. Available in circle or square sheets and in multiple thicknesses. Packages of 100 sheets.

See catalog page 148 for order numbers or GHOrthodontics.com

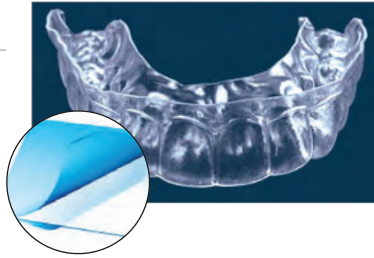

Aligner Remover

Patient-friendly, unique design allows easy and safe removal of aligners. Its ergonomic shape and two specially designed hooks help remove aligners with ease. Can also be used to place and remove elastics on traditional braces.

25/pkg.

ART01

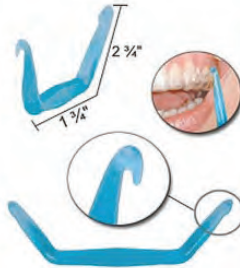

Gestenco International AB, Sweden

De-Tacher™ Aligner Removal Tool

A special patient tool for removing aligners in the mouth. Ergonomically designed for easy removal of aligners in both upper and lower jaws. Made of titanium-coated steel to prevent nickel allergies.

Ea.

DT-00-01



Chewies™

Aligner Tray Seaters

Help patients seat aligners correctly. Chewies™ Aligner Tray Seaters are the same size as a standard dental cotton roll - but better! Made of soft plastic, they're hygienic and easier to use. 20 per package.

Mint (Green)

AC-25GMPP

Bubble Gum (Pink)

AC-25PBGP

Unscented (White)

AC-25WPP



Hole Punch

Designed to place a round hole in any location on the aligner. No heat necessary, saving time chairside.

Ea.

077-HP6



Dimple Instrument

Designed to place a 1mm dimple in any location on the aligner. No heat necessary to place dimple.

Ea.

077-ID1



Reliance®

Bond Aligner

A clear light-cure adhesive to adhere metal, ceramic, or plastic attachments to any aligner plastic. 1.5g syringe.

Ea.

BA

G&H® carries the complete line of Reliance® bonding products!



Gestenco International AB, Sweden

Freddy™ Bondable Ceramic Button & Hook

Maintain the transparent look with aligners as anchorage for elastics. Work lingually and labially. Anatomical mesh base for strong bond. Both fit all teeth, though typically applied to cuspids.

Button, 10/pkg.

CLB10

Hook, 10/pkg.

FCB-00-01HK



Enchanted™ Series, Latex

Intraoral Elastics

Precision manufactured by G&H® from the finest surgical grade natural latex rubber to ensure reliable force delivery. Available in sizes 1/8", 3/16", 1/4", 5/16", 3/8" and in Light, Medium, Heavy, Extra-Heavy force values. 50 patient packs of 100 elastics per box.

See catalog page 98 for order numbers or GHOrthodontics.com



Each patient pack includes an elastics placement tool.

Battery Operated

Sonic Cleaner

Gets appliances, including retainers, sparkling clean in 5-10 minutes. When used in conjunction with Retainer Brite® tablets. Cleans deep - at 6,500 waves per second, and is a compact 3 1/2" x 4". Operates on two AA batteries (not included). Six-month replacement warranty included.

NOTE: Sonic Cleaner and Retainer Brite are US sales only.

Ea.

SCL

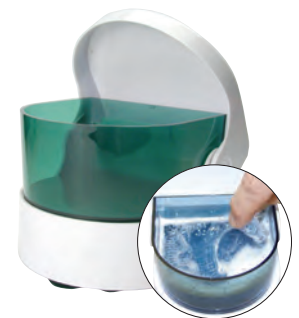

Retainer Brite®

Retainer Brite® cleaning tablets clean retainers, nightguards, mouthguards, splints, and most other removable appliances.

- Helps remove plaque and tartar
- Kills germs & bacteria
- Cleans & brightens appliances

NOTE: Retainer Brite is US sales only.

36 tablets/pkg.

RB-36

96 tablets/pkg.

RB-92



Light Cure Bonding Adhesives



Reliance® GoTo™ Light Cure Bracket Adhesive

- Unique viscosity properties
- Single piece flash clean up - "roping" off the tooth
- No bracket floatation

GoTo™ Paste (1) 4g push syringe **GTP**
GoTo™ Paste in Tips 4g paste in tips **GTT**

Reliance® Pad Lock™

Light cure bonding adhesive - creates a combination mechanical and chemical bond.

Components—

- (1) 4.5g syringe
- (1) 4.5g syringe w/fluoride
- 4.5g in (10) tips
- 4.5g in (10) tips w/fluoride



PLP
PLPF
PLT
PLTF

KIT—

(4) push syringes, 4.5g in each w/fluoride **PLPKF**

Reliance® Assure® Light Cure Band Cement

Fluoride releasing light cure orthodontic adhesive. Assure® is the ideal viscosity to prevent bracket floatation while maximizing bond strength by chemically bonding to metal bracket bases. This single paste light cure adhesive releases a high level of fluoride and will bond to slightly contaminated sealant.

Assure® Paste (1) 5g screw syringe **APP**

KIT—

Assure® Kit Paste in (4) 5g screw syringes **AKP**

Reliance® L.C.R.™ Light Cure Retainer

Highly filled, single paste light cured retainer adhesive.

Components—

(1) 5g push syringe **LCR**
5g paste in (11) tips **LCRTS**

KITS—

20g in (4) push syringes **LCREP**
20g paste in (44) syringe tips **LCRET**



Reliance® Light Bond® Light Cure Bonding Adhesive

Fluoride Releasing: Light Bond™ Paste and Sealant are formulated with a patented fluoride releasing monomer. University studies have shown that fluoride is continuously released throughout the mouth without reducing bond strength.

Smooth, Tacky Paste Viscosity: The viscosity of Light Bond™ Paste is very tacky which totally prevents bracket floatation. If a thinner paste viscosity is desired for bonding lingual retainers and palatal expanders, Light Bond™ Medium or Thin Paste is available. Specify when ordering.

Total Paste Polymerization Under All Bracket Bases: Light Bond™ is comprised of a unique catalyst and filler that reflects the light to ensure complete polymerization under any appliance - metal, ceramic, sapphire or plastic. Once the material has been properly cured, an active archwire can be placed immediately.

Choice of Protective Sealants: Conventional chemical cure sealants do not totally polymerize due to oxygen inhibition. Light Bond™ Sealant totally polymerizes when exposed to a visible light source for 10 seconds. As a result, the etched enamel surface is sealed with a clear fluoride releasing enamel protective sealant. Also available is Light Bond™ Filled Sealant, which contains 40% micro particle size filler making it abrasion resistant and fluoride releasing.

COMPONENTS—

Regular Paste

- 5g in (11) Syringe Tips **LBPTF**
- 5g in (10) Long Nose Syringe Tips, w/Fluoride **LBPTFLN**
- (1) 5g Push Syringe, w/Fluoride **LBPPF**
- (1) 5g Push Syringe **LBPP**
- (1) 5g Push Syringe, Blue, w/Fluoride **LBPPPF**
- (1) 5g Screw Syringe, w/Fluoride **LBPSF**

Medium Paste

- 5g in (11) Syringe Tips **LBMPTF**
- (1) 5g Push Syringe **LBMPPF**

Thin Paste

- 5g in (11) Syringe Tips **LBTPTF**
- (1) 5g Push Syringe **LBTPPF**

- Light Bond™ Sealant 3 cc **LB33F**
- Light Bond™ Filled Sealant 3 cc **LBFS3F**
- Light Bond™ Sealant 7 cc **LB57F**
- Light Bond™ Filled Sealant 7 cc **LBFS7F**

Note: Paste is available in 3 viscosities: Regular / Medium / Thin. Regular is sent if not otherwise specified.

KITS—

Light Bond™- Reg. Paste **LBETF**
20g paste in (44) Tips **LBEPF**
Paste in (4) 5g Push Syringes

Suitable for use with MiniMold system, page 112



Reliance® Quick Cure™

Light activated orthodontic adhesive.

Components—

(1) 5g push syringe **QCPP**
5g in (11) tips **QCPT**

Suitable for use with MiniMold system, page 112
KIT—

20g paste in (4) push syringes, with 6cc Light Bond® Sealant **QCPLB**

Reliance® Therma-Cure™

Heat curable lab adhesive for indirect bonding.

(1) 5g syringe **TC**



Reliance® Flow Tain®

Flow Tain® is a new flowable light cured composite with low viscosity which makes it ideal for bonded lingual retainers and splints.

Flow Tain® (medium viscosity) 1.5g Syringe with (10) needle tip cannulas (19 gauge) **FT**

Replacement needle tip cannulas (10) **19TIPS10**

Flow Tain® LV (light viscosity) 1.5g Syringe with (10) needle tip cannulas (22 gauge) **FTLV**

Replacement needle tip cannulas (10) **22TIPS10**



Reliance® Bonding Aligner Adhesive

Clear light cure adhesive to adhere metal, ceramic or plastic attachments to any aligner plastic.

Ea. **BA**

Note: Select Reliance products may not be available for Canadian shipment.

Mixed Paste Self-Cure Bonding Adhesives



Reliance® Phase II®

Fluoride releasing sealant/paste system.

Components—

- Paste A - 18g jar **PJAF**
- Paste B - 18g jar **PJB**
- Paste A - (1) 6g screw syringe **1PSAF**
- Paste B - (1) 6g screw syringe **1PSB**
- Sealant Resin A - 7g **S7AF**
- Sealant Resin B - 7g **S7B**
- Economy Sealant Resin A - 20g **S20AF**
- Economy Sealant Resin B - 20g **S20B**

KITS—

- Paste in (6) 6g screws syringes **PSF**
- Paste in (2) 18g jars **PJF**

Reliance® Phase II® Dual Cure

Fluoride releasing sealant/paste system.

Components—

- Paste A - 18g jar **DCJAF**
- Paste B - 18g jar **PJB**
- Paste A - (1) 6g screw syringe **1DCSAF**
- Paste B - (1) 6g screw syringes **1PSB**



Reliance® Excel®

Fluoride releasing specialty bonding adhesive.

Regular set = 3 minute working time
Fast set = 60 second working time

Components—

- Regular paste A - 12g jar **ERJAF**
- Regular paste A, Blue - 12g jar **ERBJAF**
- Regular paste B - 12g jar **ERJB**
- Regular paste A - (1) 6g screw syringe **1ERSAF**
- Regular paste B - (1) 6g screw syringe **1ERSB**
- Fast paste A - 12g jar **EFJAF**
- Fast paste B - 12g jar **EFJB**
- Fast paste A - (1) 6g screw syringe **1EFSAF**
- Fast paste B - (1) 6g screw syringe **1EFSB**
- Sealant resin A - 7g **S7AF**
- Sealant resin B - 7g **S7B**

KITS—

- Regular set - paste in (2) 12g jars **ERJF**
- Regular set - (4) 6g screw syringes **ERSF**
- Fast set paste in (4) 6g screw syringes **EFSF**

For Herbst and all large acrylic appliances
Regular Set Paste in (2) 12g jars **EHJF**
Regular Set Paste in (4) 6g screw syringes **EHSF**

No-Mix Self-Cure Bonding Adhesives



Reliance® Rely-A-Bond®

No-mix adhesive in both fluoride and non-fluoride releasing formulas.

Components—

- Paste (1) 14g jar **RPJ**
- Paste (1) 3.5g push syringe **1RPP**
- Paste - thin (1) 3.5g push syringe **1RPPT**
- Paste - 14g in (33) syringe tips **RPT**
- Primer - 16g **RPRF**

KITS—

- Non-Fluoride, 14g paste in (4) push syringes **RP**
- Fluoride releasing, 14g paste in (33) tips **RTF**
- Fluoride releasing, 14g paste in jar **RJF**
- Fluoride releasing, 14g paste in (4) push syringes **RPF**

RETRACTORS AVAILABLE
ON PAGE 109

Note: Select Reliance products may not be available for Canadian shipment.

Sealants

Reliance® Pro Seal™

Light cure fluorescing filled sealant with fluoride.

Pro Seal™ is a state-of-the-art fluoride protective sealant and its armor like strength protects the enamel surface.

6ml bottle **PRO**



Reliance® L.E.D. Pro Seal™

Filled sealant with fluoride, cures with any LED curing light.

6ml bottle **LEDPRO**



Reliance® Assure® Sealant

Universal bonding agent.

Assure® Sealant will increase adhesion to normal, atypical, dry or slightly contaminated enamel. Bonds to metal restorations without additional primers. No light curing required and it can be used with any light or chemical cure system.

6cc bottle **AS**



Reliance® Assure® Plus

All surface bonding resin.

Assure® Plus will increase adhesion to normal, atypical, dry or slightly contaminated enamel and zirconia and acrylic temps without additional primers. Bonds to metal and porcelain restorations without hydrofluoric acid.

6cc bottle **PLUS**



Reliance® Maximum Cure®

Fluoride releasing, chemical cure sealant system.

Components—

- Sealant A - 7g **MC7AF**
- Sealant B - 7g **MC7B**
- Filled sealant A - 7g **MCF7AF**
- Filled sealant B - 7g **MCF7B**
- Economy sealant A - 20g **MC20AF**
- Economy sealant B - 20g **MC20B**

Reliance® Custom I.Q.™

Fluoride releasing, fast set indirect bonding sealant.

Components—

- Sealant A - 7g **CIQA**
- Sealant B - 7g **CIQB**

Cements



Reliance®
Ultra Band-Lok™ Light Cure Band Cement

Fluoride Releasing: Single paste cement which bonds chemically to metal.

No Wasteful Mixing: Single paste system.

Light Activated: No working time constraints.

All Purpose Cement: Ultra Band-Lok™ can also be used to bond brackets, lingual retainers and large acrylic appliances. When bonding these appliances, you must first etch the enamel surface.

Available In: Translucent tooth shade to blend in or blue shade to aid in clean up prior to curing.

COMPONENTS—

Ultra Band-Lok™ Paste **UBLPP**
(1) 5g Push Syringe

Ultra Band-Lok™ Paste Blue **UBLBPP**
(1) 5g Push Syringe

Ultra Band-Lok™ Luer Loc Syringe **LLUBLP**
(1) 5g syringe w/10 tips, 15 gauge tips

Ultra Band-Lok™ Luer Loc Syringe (Blue) **LLUBLBP**
(1) 5g syringe w/10 tips, 15 gauge tips

Luer Loc Tips for UBL Syringe **LLTIPS**
60 Tips/pkg.

Note: LLTIPS is not available for Canadian shipment.



Economy Kit

Reliance®
Precedent®

Fluoride releasing, glass ionomer.

Components—
Powder 100g **PRP100**

KITS—
Starter kit - 15g powder, 15cc liquid **PRS**
Economy kit - 100g powder, 90cc liquid **PRE**



Reliance®
Band-Lok™

Self-cure, fluoride releasing, two paste glass ionomer band cement.

Band-Lok™ is a dual cure cement. It can be used with or without a curing light. When band is placed and flash is cleaned, a 20-second light activation allows full protection from moisture. Without light activation, a complete set is achieved in 10 minutes.

Components—

Paste A - (1) 6g screw syringe **BLSA**
Paste A - (1) 6g screw syringe (blue) **BLSAB**
Paste B - (1) 6g screw syringe **BLSB**

KITS—

Economy kit - paste in (8) 6g screw syringes **BL**
(4) of part A and (4) of part B

Economy kit (blue) - paste in (8) 6g screw syringes **BLB**
(4) of part A (blue) and (4) of part B



Reliance®
Crown Lok™

Self-cure, fluoride releasing, two paste band cement.

Crown Lok™ is a self-curing two minute working time fluoride releasing cement. This versatile cement will bond chemically to all metal crowns, bands, and appliances, reducing the chance of failure and facilitating cleanup at the conclusion of treatment. Available in tooth color shade or high visibility blue.

Components—

Paste A - (1) 6g screw syringe **CLSA**
Paste B - (1) 6g screw syringe **CLSB**

KIT—
A blue and B pastes kit - (4) 6g screw syringes **CLB**

Veneer Paste



Reliance®
O.V.S.™
Orthodontic Veneer System

O.V.S. will provide a complete in-office system that creates an esthetic and properly sized temporary veneer surface to bond your attachment. This saves you and your patients both time and money by eliminating the need for a full temporary crown.

Kit **OVS**

Individual Components

Shade A-1, Syringe **OVP A1**
Shade A-2, Syringe **OVP A2**
Shade B-1, Syringe **OVP B1**

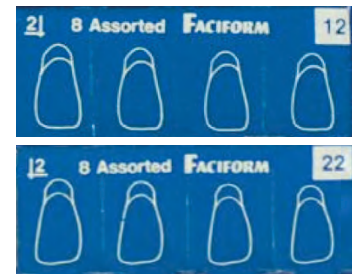

Reliance®
Faci Forms

(4) medium & (4) large - 8/pkg.

Left #12 **FFL**
Right #22 **FFR**

Pontic Paint

Reliance®
Perfect-A-Smile™

Perfect-A-Smile is a single light cure paint that comes in 3 shades and can be painted on any aligner material to mask a space or missing tooth.



Shade B-1, Light Shade - 4g jar **PPB1**
Shade A-2, Medium Shade - 4g jar **PPA2**
Shade A-3, Dark Shade - 4g jar **PPA3**

Note: Select Reliance products may not be available for Canadian shipment.

Retention Systems

Reliance® Retainium™



Single strand Nickel-Free titanium flat metal ribbon is ideal for semi-permanent splinting and maintaining difficult extraction sites.

- Eliminates potential patient allergy issues
- Reduced wear rate
- Increased interproximal strength
- 60" total - 10 (6inch) strands
- Dimensions: Standard: .027" x .011" ribbon arch wire (10) 6 inch strands/pkg.

RET

Reliance® XL Retainium™



Extra Reinforced Single strand NICKEL FREE titanium flat metal ribbon with increased interproximal strength is ideal for semi permanent splinting and maintaining difficult extraction sites.

- Eliminates potential patient allergy issues
- Reduced wear rate
- Increased interproximal strength
- 60" total - 10 (6inch) strands
- Dimensions: Standard: .027" x .016" ribbon arch wire (10) 6 inch strands/pkg.

XLRET

Reliance® Ortho FlexTech™



The next generation in lingual retention.

- Stabilizes orthodontic corrections
- Prevents rotational relapses
- Easy application - naturally forms to lingual arch curvature
- Less doctor time / less chair time
- Low failure rate due to "flex linkage"
- No laboratory costs or delays
- Improved patient comfort - lays flat against the teeth
- Lasting esthetics - 14k gold or stainless steel
- 30" length - makes 25 cuspid to cuspid retainers

- 14 karat gold - 30" length
- 14 karat gold, Etched - 30" length
- Stainless Steel - 30" length
- Stainless Steel, Etched - 30" length

OFT2
OFT
SSOFT
SSOFTE

Reliance® Hilgers Bond-A-Braid™

The dead soft wire easily adapts and is excellent for semi-permanent orthodontic splinting of the upper and lower incisors, diastema maintenance and other tooth splinting.

- Lingual retainer
- .027" x .011" ribbon arch wire
- 8-strand braided wire
- Dead soft - adapts easily

6" length - 10/tube

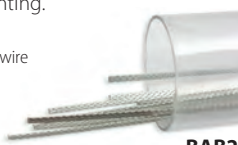

BAB2

Reliance® Extend™ Long Term Retainer

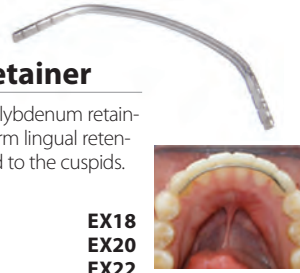

Nickel-free titanium molybdenum retainer wire used for long term lingual retention that is only bonded to the cuspids.

- 5/pkg.
- 18mm
- 20mm
- 22mm
- 24mm
- 26mm

EX18
EX20
EX22
EX24
EX26

Boosters

Reliance® Enhance L.C.™

Single component Enhance™ light cure.

Enhance™ L.C. - 6cc

LCE6



Enhance™ Adhesion Booster - for hypo-calcified or fluorosed enamel

- Part A - 3cc
- Part B - 3cc
- Part A - 6cc
- Part B - 6cc

EBAA
EBAB
EBAA6
EBAB6

Prep & Finish

Reliance® 1st & Final™

Pre-packaged orthodontic pumice. 200/pkg.

FF



Reliance® Renew Finishing System™

Adhesive removal & finishing system.

- Bur - 118S (1)
- Bur - 118L (1)
- Bur - 218 (1)
- Point - 383 (12) straight handpiece
- Point - 383 (12) latch
- Point - 383 (12) friction grip
- Diamond Bur - 129 (1)

RSB
RSBL
RSB2
RSPHP
RSPL
RSPFG
DB

Restore Diamond Polishing Paste 2 oz. (56.7g)

RESPP2



Reliance® Self Mixing Tips

Special mixing cannula tip which eliminates operator mixing and provides a consistent, automatic mix.

15/pkg.

SMT

Etchants & Conditioners

- Reliance®
Plastic Conditioner 10cc
- Porcelain Conditioner 8cc
- Metal Primer 10cc

PL
PO
ME



Reliance® Porc-Etch™

Porcelain etching agent (7g), includes (3cc) barrier gel

POE



Reliance® Etchant

Etchant Liquid Bottle - 9g Economy size - 18g

EL9
EL24

Etchant Gel

Bottle - 9g Economy size - 18g

Economy syringe pack

(1) 6.5g syringe w/20 tips

EG9
EG18
EGSS



Reliance® S.E.P.™ Self-Etching Primer

S.E.P. Primer Refill

(1) refill cartridge - enough for 50 arches

SEPR



Reliance® Barrier Gel

(1) 3cc bottle.

GEL



Reliance® Blue Etchant Gel

(1) 5 gm syringe with 10 tips.

BEGS



Reliance® Gel Etchant

37% phosphoric acid 226g (8 oz.) Bottle

090-8193



Clinical Training Aids

- Reliance®
Chairside Bonding Technique Cards
- Clinical Training Videos - Bonding DVD

TECH
DOBRG2



Note: Select Reliance products may not be available for Canadian shipment.

Ketac-Cem®

Permanent glass ionomer luting cement.

Intro Pack -

12mL liquid, 33gm powder, mixing pad

Kit **37201**

Triple Pack -

(3) 12mL liquid, (3) 33gm powder

Kit **37231**

Giant Pack -

(10) 12mL liquid, (10) 33gm powder, 2 mixing pads, 2 liquid droppers

Kit **37251**

Powder -

33gm bottle

Btl. **37211**

Liquid -

12mL bottle

Btl. **37221**



GC

Fuji Ortho

LC Intro Kit

One 15g powder, one 6.8ml bottle of liquid, mixing pad and scoop.

439401

LC Standard Kit

40g powder, 2 x 8g liquid, measuring scoop & mixing pad.

439403

Note: 439403 is not available for Canadian shipment

LC Components

40g Powder

000029

6.8ml Liquid

000030

8ml

000206

LC Capsules

50 capsules

439450

0.30g Powder & 0.10g Liquid per capsule

Band Paste Refill

Two 13.3g (7.2ml) Paste Pak Cartridges of Fuji Ortho Band.

001888

SC Standard Kit

Contains: One 40g powder, two 6.7ml bottles of liquid, mixing pad and scoop.

439503

Ortho Paste Starter Pack

Fuji Ortho Band Paste Pak cartridges, 1 mixing pad, 1 paste pack dispenser and 1 mixing spatula

439460



Microbrushes®

100 per tube, 4 tubes per package.

Fine, Pink & Yellow

MFA400

Assorted

MBAS400

Microbrush Dispenser Kit - Fine

PF400-KIT

Microbrush Dispenser Kit - Reg.

PR400-KIT

Microbrush® is a registered trademark of Microbrush



Pre-Bent

Dispensing Tips

100 per package.

Yellow - 20 gauge

PN-1228

Grey - 22 gauge

PN-1230

Blue - 25 gauge

PN-1231

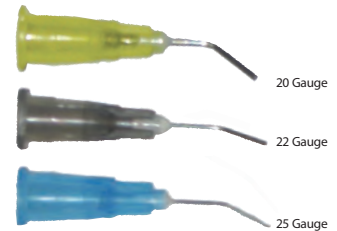

Mini Tip Applicators

144 per package.

Purple

8202-10N

Black

8202-11

Blue

8202-2

Yellow

8202-3

Green

8202-4

Red

8202-5



Reliance®

Benda-Brush

Benda-brushes are both economical and disposable. The 2" long brush has a ribbed handle for a better grip when applying adhesives or etchants.

250/pkg.

BB250



**Reliance®
Brush Tips**

1cm long handle.
250/pkg. **BT250**



Disposable
Brush Tips

1.5cm long handle.
100/pkg. **BDBT**
**Handle for 1.0 cm & 1.5 cm
brush tips**
Ea. **MMH**



Economy
Bonding Brushes

2" long handle.
400/pkg. **BND400**



**Reliance®
Sponge Pellets**

500/pkg. **SP**



Richmond®
Cotton Pellets

2,000/box **100106**



**Reliance®
Mixing Spatula**

50/pkg. **S**



Economy
Mixing Spatulas

50/pkg. **030-003**

**Reliance®
C.R. Syringe Mark II**

Specifically designed for use with all
Reliance® adhesives dispensed in a
syringe tip.
Ea. **CR11**



**Reliance®
Mixing Wells**

Ea. **1MXW**



**Reliance® S.E.P.
Mixing Wells**

Ea. **1SEPW**



Disposable
Mixing Wells

200/pkg. **900MW-2**



**Reliance®
Mixing Pads**

2.25"x2.25" - 75 sheets
Ea. **1PADS**



Disposable
Dappen Dish

200/pkg. **901DD**



Diadent
Glass Dappen Dish

Ea. **601-001**



Tidi® Saliva Ejectors

100/pkg.
White **9306**
Clear Blue **9307**



Hygoformic Saliva Ejectors

100/pkg. **8111**



Oral Evacuators

100/pkg.
1/8" diameter **VE-1121**



Beesure Saliva Ejectors

100/pkg. **954-9890**



HVE Tips

100/pkg. **954-9891**

Disposable Air/Water Syringe Tips

250/pkg.
Clear/Clear **TST-0**
White/Clear **TST-1**
Blue/Clear **TST-2**
Yellow/Clear **TST-3**
Green/Clear **TST-4**
Purple/Clear **TST-10N**
Assorted Colors **TST-A**



Sani Tips

250/pkg. **STIPS**

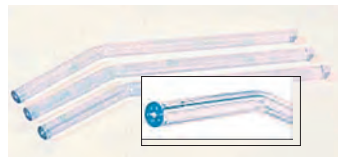

Metal Syringe Tips

5/pkg. **990-0038**



Evacuation Saliva Ejector Traps

72/pkg. **8100**



Evacuation Screens

144/pkg.
1 7/8" Dia. - Green **G8178-3**



Disposable Tongue Blocks

Keeps the tongue away from the teeth during bonding and banding procedures. Soft plastic construction allows for easy trimming if needed.

50/pkg.
Scented
Medium **TB-D**
Small **TB-DS**
Regular - Super Soft **TB-SSD**
Small - Super Soft **TB-SSDS**

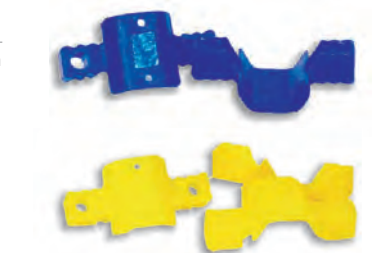

Unscented
Medium **TBU-D**
Small **TBU-DS**

Absorbent NeoDrys™

50/pkg.
Large **DYL**
Small **DYS**



Flexible Dry Tips

50/pkg.
Small **161000-10**
Large **161100-10**



Absorbent Dry Angles

Large Plain - 160/box **31L**
Small Plain - 200/box **31S**
Large Foil - 160/box **32LAG**
Small Foil - 200/box **32SAG**



premier

Lip & Cheek Retractors

Anatomic design with cushioned lip-supports that position lips away from anterior teeth and gums. Autoclavable, latex-free.

2/pkg.

Small (blue) **9061383**
 Universal (white) **9061381**

Cushion refills (10) **9061382**



Cheek Retractor

- Soft material for patient comfort
- Full function design
- Includes handles which may be held by the patient
- Effective for intra-oral photos as well as bonding

Autoclavable - 134°C-273°F Max.

Ea. **CR-00-01**



Cheek Retractor

Assure accessibility throughout the oral cavity. Stainless steel bow provides comfort and durability. Intraoral extensions fully retract cheeks. Dry heat and autoclave compatible.

Autoclavable - 177°C-350°F Max.

Adult (ea.) **CH1**
 Pediatric (ea.) **CH2**



Cheek Retractor

Extraoral, autoclavable.

Adult (ea.) **EXO-2S**
 Pediatric (ea.) **EXO-1**



Cheek & Tongue Retractor

A classic design provides comfortable cheek retraction while blocking the tongue. Available in two materials.



Disposable

10/pkg. **PCKE-1D**
 Large (Red) 10/pkg. **EX-9006-L**

Autoclavable - 125°C-257°F Max.

Ea. **PCKE-1**

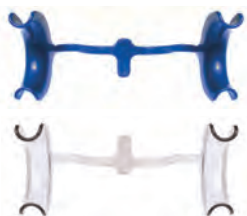

TLC Retractor

Tongue, Lips & Cheek - designed to maximize intraoral exposure for any treatment procedure. Lips and cheeks are retracted simultaneously while the tongue is blocked. Soft material and gentle force insures patient comfort.

Autoclavable - 127°C-260°F Max.

2/pkg.

TLC



Cheek Retractor

Double-Ended, Autoclavable to 250° F, Clear, 2 pcs/box

Adult 2/pkg.

EX-9004

Pedo 2/pkg.

EX-9005



"V" Cut

Cheek Retractor

2/pkg.

Autoclavable **BPR-1A**

Cold Sterilizable **BPR-1D**

High Heat Sterilizable **BPR-1S**



Gingival Lip Retractor

Designed to provide vertical (gingival) lip retraction.

Autoclavable - 134°C-273°F Max.

2/pkg.

Adult **LR-00-01**

Pediatric **LR-00-02**



Cheek Retractor

Autoclavable, 2/pkg.

Large

EX-9002

Small

EX-9003



Disposable

Mouth Props

48/pkg.

Small

EX-9060

Medium

EX-9050

Large

EX-9040



Nola

Dry Field Kit

The Nola Dry Field System completely eliminates saliva and fully exposes both arches making it ideal for all bonding applications. Autoclavable. Kits contain: Cheek Retractor, Suction Connections, Tongue Guard, Tubing.

Kits

Child, Red (ea.) **300-400**
 Adult, White (ea.) **300-401**

Component Parts

Tongue Guard, Lg., White (ea.) **300-403**
 Tongue Guard, Sm., Red, (ea.) **300-413**
 Retractor, Lg., White (ea.) **300-406**
 Retractor, Sm., Red, (ea.) **300-414**
 Lip Retractor, Adult, (ea.) **300-612**
 Low Volume Adapt., 4/pkg. **300-419**
 High Volume Adapt., 4/pkg. **300-420**
 Y-Connectors, 4/pkg. **300-408**
 Silicone Tubing, 10/pkg. **300-412**
 Flexible Connector, Lg. (ea.) **300-405**



Note: Cheek retractor ends disassemble from bow for easy cleaning.

Disposable

Bracket Tray

25/pkg.
 Aqua
 Blue
 White

BT2003-4T
BT2003-2X
BT2003-1



Bracket Tray Holder

Holds 10 trays
 • Organizes brackets for each patient
 • Good for transporting
 • Economical
 • Dimensions: 6 1/4" H x 6 1/2" W x 3"D

Ea.
 Smoke
 Clear

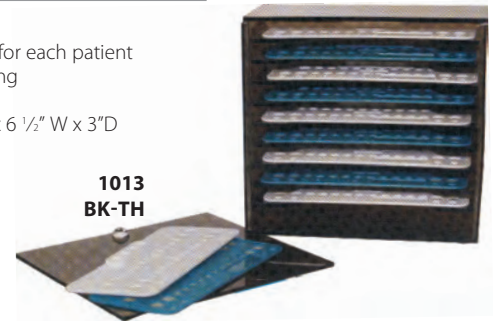

1013
BK-TH

WET FIELD BONDING

Bond High Cuspids Successfully with SmartBond!



NOTE: SmartBond® is a filled cyanoacrylate base adhesive. Care should be taken in dispensing, use and storage to avoid unintended adhesion.

SmartBond® Adhesive

SmartBond® is a true one-step adhesive that bonds in a wet field. In fact, SmartBond® adhesive is activated only when it contacts moisture. Teeth are cleaned and etched for bonding as usual, but when the etchant is rinsed off, the next step is to bond. There is no drying, no sealants and there is no dry field to maintain. SmartBond® activation begins when a bondable attachment is delivered to the tooth and the adhesive contacts wet enamel. Five-second working time, five-minute bond set.



GREAT REFERRAL FOR ORAL SURGEONS!

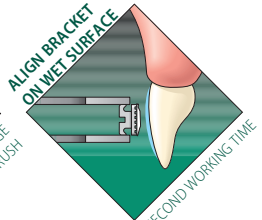
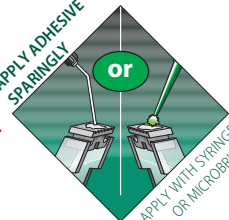
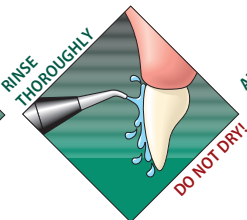
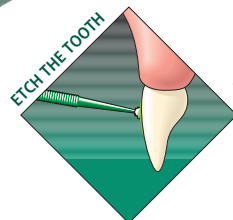

SmartBond®

Instant cyanoacrylate adhesive
 Mini-kit 3g (Includes 20 tips) **SM-000**
 Economy Kit 6g (two 3g) (Includes 40 tips) **SM-001**
 Trial Kit 1g (Includes 10 tips) (does not include etch or microbrushes) **SM-010**
 Refill Syringe 3g **SM-002**

SmartBond® Component Parts

Luer Lock Tips (18 gauge - 40 per box) **SM-005**
 Etch Gel Syringe 6g **SM-003**
 Micro-Brushes (box of 50) **SM-004**

Refrigerated storage of SmartBond® recommended.

Note: SmartBond® is not available for Canadian shipment.

SmartBond is a registered trademark by Gestenco International AB, Sweden.

Companion Products

Eruption Appliance

Extrusion Chain w/Hook



Bondable to cuspids impacted palatally or labially. 1" (approx.) traction chain swings freely within the eyelet. .022" inner diameter chain can be tied to the archwire with elastic thread or tubing to provide traction in the desired direction. 3.5mm diameter (flat) - 80 gauge foil mesh base assures reliable bonding, low profile limits irritation, 14k gold and titanium nitride-coated hook & chain reduces possibility of allergic reactions.

Ea. **EXHK14K**

Stainless Steel Bondable

Extrusion Hook

Mesh pad for secure bonding.

Package of (10)

EXHK



MICROBRUSHES deliver just the right amount of liquid directly where desired, without waste. Four-pack assorted colors: one each of green, purple, orange and blue.



400 total brushes

MBAS400

Microbrush® is a registered trademark of Microbrush



1-Year Warranty!

LEDEX™ WL-070+ Portable LED curing light

The LEDEX™WL-070+ portable/rechargeable LED curing light bonds an entire arch without light intensity degradation or excess heat.

- 10-second bracket cure time
- Cordless operation
- Easy-to-read LED display
- Simple mode selection
- Built-in intensity indicator
- Low-heat for patient comfort

DC101

Includes: Handpiece, Power supply (AC100~240V/DC5V), Optical fiber light guide rod (Ø8mm), Filter, Anti-glare shield, Wireless charging stand, Light guide sleeve, Curing light sleeve, Instructions for use.

Component replacement parts

Curing light handpiece **DC011**
 Power supply (U.S.) **DC024**
 Wireless charging stand **DC025**

- Light source: High power dental blue 5 W LED, average lifespan is 100,000 hours
- Wavelength: 440-480nm, peak: 460nm
 Radiant intensity: up to 1200 mW/cm²

Handpiece

- Light guide rod: Ø8mm optical fiber, sterilizable in autoclave (max. T. 135°C for 20 minutes)
- Weight: 120g (with battery & light guide rod)
- Dimensions: Ø 26 (max) x L156mm

Wireless charging stand

- Weight: 85g
- Dimensions: W45 x L135 x H40mm

Battery

- Type: Lithium-ion, 3.7 V/800 mAh
- Charge time: About 3 hours
- Use time: 40 minutes (200 times in 10 sec. mode)

Power supply

- Type: Micro USB
- Input: 100 ~ 240 V, 50-60 Hz
- Output: DC 5 V/2 A

"I find the LEDEX™ curing light from G&H® to be an effective part of our clinical bonding technique. The light's portability and high intensity make it an important part of our bonding success rate."

Robert J. Gange, DDS, MS – Windsor, CT

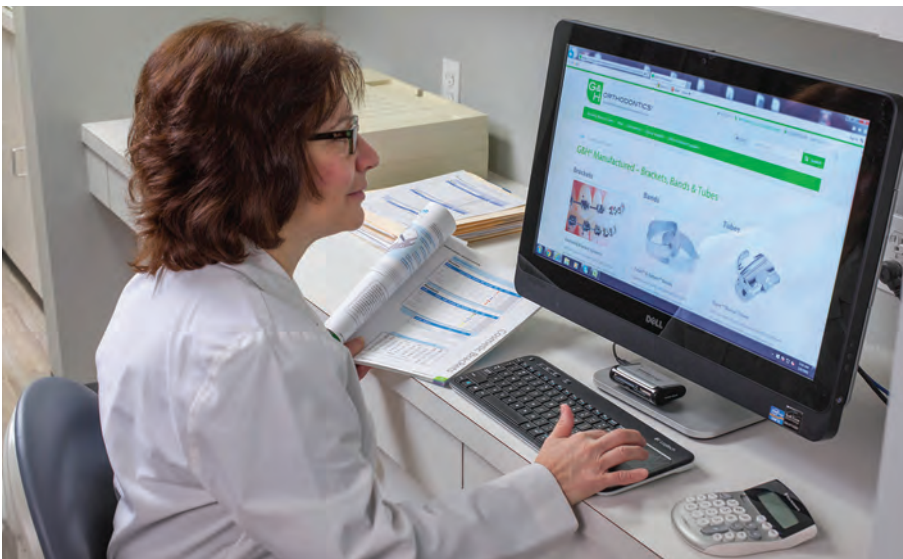

Discover Your Orthodontic Buying Power!

Your membership in the G&H OrthoClub® results in big savings. Enjoy buying-group savings on more than 6,000 brand-name clinical supplies including G&H manufactured products.

Direct Bond Auxiliary Appliance Fabrication

Mini-Mold Kits™

The various molds fabricate buttons, bite ramps, habit control spikes, temporary brackets, molar tubes, molar pads and create uniform lingual retainer bonds using light cure adhesives. Each mold is designed to pack with light cure adhesive, press against tooth, cure and peel away mold leaving a formed auxiliary on any tooth in just minutes.

Any light-cure adhesive can successfully be used with Mini-Molds™ – L.C.R.™ adhesive from Reliance® is recommended. (See page 102).

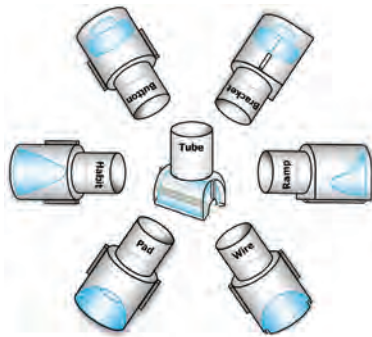

Wire Bonder Tips - Small and Large

Starter kit features three of each mold design, two application handles and instructions.

Ea.

MMASSTK

Individual mold designs

Kits include handle and instructions.

- Wire Bonder Kit Small (10 tips)
- Wire Bonder Kit Large (10 tips)
- Button Bonder Kit (10 tips)
- Bracket Bonder Kit (10 tips)
- Habit Control Bonder Kit (10 tips)
- Cuspid Ramp Kit (8 tips)
- Bite Ramp Bonder Kit (3mm) (8 tips)
- Bite Ramp Bonder Kit (5mm) (8 tips)
- Lateral Bonding Kit (4 tips)
- Tube Bonder Kit (10 tips)
- Molar Pad Tip Kit (10 tips)
- Universal Bite Opening Kit (16 tips)
(4 ea. 3mm, 5mm, cuspid ramp, & pad)

- MMWBKSM**
- MMWBKLG**
- MMBTNK**
- MMBRKTK**
- MMHCK**
- MMCUSRK**
- MMBITEK**
- MMBITE5K**
- MMLATB4K**
- MMTBK**
- MMMPTK**
- MMUBITEOK**

Handle only

MMH

Direct Bond Occlusal Appliance

Bite-Bumper™

Bite-Bumpers™ work to open deep bite cases by allowing the anteriors to ride up and out of occlusion. The Bite-Bumpers™ eliminate bond failures of brackets and are especially valuable with ceramic or self-ligating brackets.

The Bite-Bumpers™ are made of a composite polymer that is more comfortable, aesthetic and will increase biocompatibility in nickel sensitive patients.

Bite-Bumpers™ are bonded in the same manner as plastic or composite brackets and have a slotted mechanical bonding base.

10/pkg.

BB-00-01

Bite-Bumper is a registered trademark by Gestenco International AB, Sweden

Note: Bite-Bumper™ is not available for Canadian shipment.



The unique fixed "placement jig" guarantees the correct height on the lingual of the tooth and makes sure the two Bite-Bumpers™ are 100% parallel.



1. Put the placement-jig against the incisal edge.



2. Remove the jig.



3. Bite-Bumper™ ready.

The placement-jig can be easily removed by hand or by a cutting instrument after bonding.

Fiber Reinforced Composite

everStick® Ortho

everStick® Ortho incorporates a thousand glass fiber strands bound together with a pre-impregnated light cure adhesive that allows adaptation directly in the patient's mouth. The integrated fiber bundle is both malleable and tacky—perfect characteristics for close adaptation and positive retention prior to curing. .030" (0.75mm) passive diameter - flattens significantly during adaptation. Refrigerated storage recommended.



everStick and StickTech are registered trademarks of Stick Tech Ltd. Oy.

Ideal for many applications:

- Lingual upper and lower retention
- Diastema retention
- Posterior anchorage
- Trauma or periodontal splinting
- Extraction site maintenance
- Segmented movement

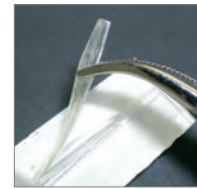

The strength and durability of glass fibers combined with filled composite

- No frayed or messy fiber ends
- Easy-to-apply chairside method
- Bonds chemically & mechanically
- Compatible with all light cure composites
- Metal free & aesthetically pleasing
- Low profile and aesthetic
- Labial or lingual placement

Box of (2) 12cm strands **EVERSTICK**

Note: everStick® is not available for Canadian shipment.

Clinical case photos of 14-year old female*

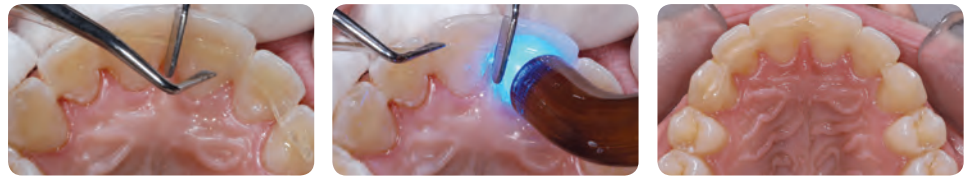

*Typical FRC application by Vittorio Cacciafesta, DDS, MSc, PhD and M. Francesca Sfondrini, MD, DDS – Italy

Companion Products



FRC Placement Tool

A double-ended spatula that is angled for ease of application and curing of FRC bonded lingual retainers and splints.

Ea. **PLACE**



Flow Tain®

A flowable light cure composite with low viscosity making it ideal for bonded lingual retainers and splints. See page 102 for full information.

Medium viscosity **FT**
Light viscosity **FTLV**

LEDEX™ Portable LED Curing Light

A powerful LED curing light - maintains light intensity without excess heat. See page 111 for full information.

Ea. **DC101**



Full Line Quality Orthodontic Products

Orthodontists have one of the most important jobs – bringing renewed self-confidence and pride to every patient through improved smiles.

Order our full line of products at: GHOrthodontics.com



The G&H® NEOsmile™ is a preformed tooth positioner that will idealize the patient's finishing occlusion upon debanding. The NEOsmile™ will maintain a Class I ideal relationship and provide some buffering against TMJ related irritations. Each NEOsmile™ incorporates molded air holes for unencumbered breathing. Like a custom tooth positioner, the NEOsmile™ is seated on the upper arch posterior on one side and stretched to the opposite side. Then the patient can gently clench to fully occlude into the appliance.

Typical Indicated Applications

Generalized spacing may be corrected by staging sizes of the NEOsmile™. When generalized spacing is present and NEOsmile™ is fitted to the patient, it is typically recommended to use a size smaller than patient's measured size. Patients with moderate generalized spacing may require the use of two concurrent NEOsmile™ positioners in incrementally smaller sizes to achieve ideal results.

Moderate space closure, band spaces, minor diastema closure, 3-4° torque, 5-8° rotation, and minor to moderate uprighting can be achieved where space is available.



Selecting the Proper Size

Determine the patient size for the NEOsmile™ by measuring the millimeter span from distal of upper cuspid to distal of opposite cuspid along the incisal edges.

The NEOsmile™ comes in three permutations. For instance, the Non-Extraction series can be used with excellent results for patients with either first or second molar extraction. For bicuspid extraction, the NEOsmile™ can be used for first or second bicuspid extraction cases. The NEOsmile™ is available in the following kits or individually in one millimeter increments as indicated.

	Non-Extraction	Four Bicuspid Extraction	Two Upper Bicuspid Extraction
Individual	PFTPS0* 42-58mm	PFTPS4* 45-60mm	PFTPS2* 45-56mm
Kit of 10 Includes ruler	PFTPS010 45-54mm	PFTPS410 47-56mm	PFTPS210 46-55mm

*Insert preferred millimeter size, available in 1mm increments.

Companion Product

MM Ruler

Our unique double-sided ruler features a hole to engage a post or hook making space measurement quick, easy and accurate!



20/pkg.



RULERMGG

Protraction Face Mask

The adaptability of the G&H® Adjustable Protraction Face Mask allows for directional force application by adjusting the elastics engagement bar to deliver protractive force in the desired plane. Fully adjustable forehead and chin rests allow for adaptation to most patient's anatomical structure. The angle of traction is then determined by adjusting the elastics engagement bar to deliver horizontal, upward or downward forces as necessary. Face mask adjustments are made with an Allen wrench (2mm Allen wrench included). Padded forehead and chin rests offer comfort for extended wear and may be cleaned. Traction force application recommends 1/2" elastics with 16 oz. pull ratings, but alternate elastics may be used if differing forces are desired. Large - 10 1/4" vert. supp. bar

Ea. **PFMLG**



Replacement Parts

Protraction Face Mask

Chin Cup w/2 pads **PFM001**
 Forehead Piece **PFM002**
 Allen Wrench (2mm) **PFA**
 Replacement Pads **PFMRP**
 Includes (2) Forehead & (2) Chin Cup



Extraoral Elastics

1/2" Bulk Pouches of 1,000 elastics in natural rubber latex
 8 oz. **AX012B**
 16 oz. **AXH12B**
 See all Elastics on pages 97-99.

Reverse Pull Face Mask

The Reverse Pull Face Mask is available in two sizes and offers comfortable anchorage for protraction. The stainless steel frame is softened chin and forehead pads to minimize irritation and maximize patient acceptance. Facemasks allow for patient customization. All adjustments are made with an Allen wrench (1.5mm Allen wrench included with each mask). Both masks include: 2 forehead pads, 2 chin pads, replacement screws & Allen wrench.

Small **RPFMSM**
 Large **RPFMLG**



Replacement Parts

Reverse Pull Face Mask

Replacement Pads **RPFMP**
 Includes (1) Forehead & (1) Chin Pad

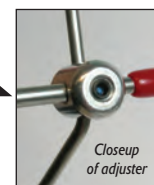

Color Coated Facebows

Color Coated Facebows have a durable color coating to resist peeling, cracking and discoloration. Available in five inner bow sizes*. Medium outer bow size, .045" diameter wire.

Facebows w/preformed omega loop - sizes 1-5

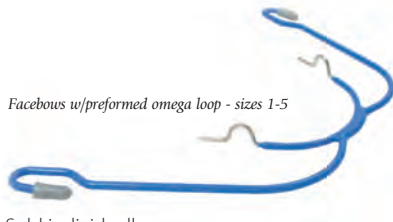

Sold individually

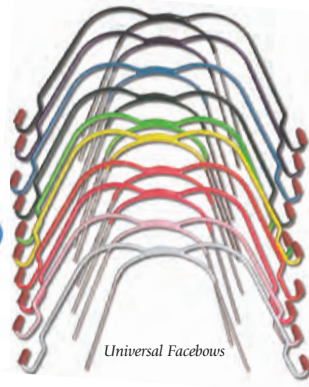

	Size 1 (83mm)	Size 2 (90mm)	Size 3 (97mm)	Size 4 (104mm)	Size 5 (111mm)	Universal
Black	CCFB101	CCFB201	CCFB301	CCFB401	CCFB501	CCFB001
Blue	CCFB102	CCFB202	CCFB302	CCFB402	CCFB502	CCFB002
White	CCFB103	CCFB203	CCFB303	CCFB403	CCFB503	CCFB003
Orange	CCFB104	CCFB204	CCFB304	CCFB404	CCFB504	CCFB004
Dark Green	CCFB105	CCFB205	CCFB305	CCFB405	CCFB505	CCFB005
Lime Green	CCFB106	CCFB206	CCFB306	CCFB406	CCFB506	CCFB006
Yellow	-	-	CCFB307	CCFB407	-	CCFB007
Purple	-	CCFB208	CCFB308	CCFB408	CCFB508	CCFB008
Pink	CCFB109	CCFB209	CCFB309	CCFB409	CCFB509	CCFB009

*Size measurements are made distal to the omega loop to distal of the other loop along the inner bow.

◆G&H* recommends using facebows only with properly designed safety release systems to prevent potential harm to patients.

Standard Facebows

Standard Facebows in bright stainless steel. Five sizes plus Universal - Available in short or medium outer bow sizes.

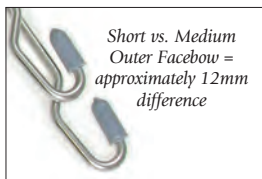

Sold individually

	Short Outer Bow	Medium Outer Bow
SIZE 1 (83mm)	STFBSH01	STFB01
SIZE 2 (90mm)	STFBSH02	STFB02
SIZE 3 (97mm)	STFBSH03	STFB03
SIZE 4 (104mm)	STFBSH04	STFB04
SIZE 5 (111mm)	STFBSH05	STFB05
UNIVERSAL	STFBSH00	STFB00



Universal Facebow pictured

Lip Bumpers

Lip Bumpers are precision shaped to relieve lip and cheek pressures and allow teeth to unravel quickly. Bumpers feature colored lip pad and include small ligating hooks for securing in place. Sizes 1-5* and Universal, .045" diameter wire.

Lip Bumpers w/preformed omega loop - sizes 1-5

(2) per pkg.

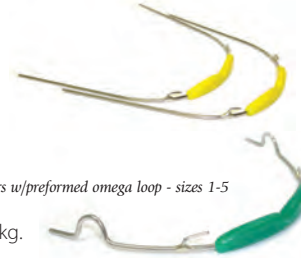

Universal Lip Bumpers

Note: All lip bumpers have ligation hooks.

	Size 1 (83mm)	Size 2 (90mm)	Size 3 (97mm)	Size 4 (104mm)	Size 5 (111mm)	Universal
Black	CCLB101	CCLB201	CCLB301	CCLB401	CCLB501	CCLB001
Blue	CCLB102	CCLB202	CCLB302	CCLB402	CCLB502	CCLB002
White	CCLB103	CCLB203	CCLB303	CCLB403	CCLB503	CCLB003
Orange	-	-	-	-	-	CCLB004
Dark Green	CCLB105	CCLB205	-	CCLB405	CCLB505	CCLB005
Lime Green	CCLB106	CCLB206	-	-	-	CCLB006
Yellow	CCLB107	CCLB207	CCLB307	CCLB407	CCLB507	CCLB007
Purple	CCLB108	-	-	-	-	CCLB008
Pink	CCLB110	CCLB210	CCLB310	CCLB410	CCLB510	CCLB010
Red	CCLB111	CCLB211	CCLB311	CCLB411	CCLB511	CCLB011

*Sizes are measured from distal of the omega loop to distal of the other loop.

Safety Release Modules

Safety Release Modules Three force ranges to provide dependable retraction. Specially designed retention clip releases at 4-5 lbs. of outward force for patient safety. 5 pairs per pkg.

	450 gr	600 gr	750 gr
Dark Blue	SRDB450	SRDB600	SRDB750
Black	SRBK450	SRBK600	SRBK750



Cervical Neckpads

Two placement loops, for adjustability, ensure accuracy of fit. Manufactured with plush padding for comfort. 5/pkg.

Confetti
Royal Blue
Denim Blue
Pink
Black

CPCF10
CPRB10
CPDB10
CPPK10
CPBK10



Close-up of stitching detail

Headgear Storage Cases

Velcro® closures conveniently store facebow and headgear to protect and organize. Perfect size for any configuration. Approximately 5.75" x 9.5" (15cm x 24cm) 5/pkg.

Black
Red
Royal Blue
Green
Purple

HGSTBK
HGSTRD
HGSTRB
HGSTGR
HGSTPP



Close-up of stitching detail

High Pull Headcaps

Two sizes of headcaps, each with two placement loops, ensures accurate fit for patients.

5/pkg. - Nylon

	Small	Large
BLACK	HPSBK5	HPLBK5
ROYAL BLUE	HPSRB5	HPLRB5
RED	HPSRD5	HPLRD5



Nylon

Headgear Pouches

Sold individually

	Key Ring	Snap Clip
Black	NJ208-03	N09/BLACK
Green	NJ208-04	
Purple	NJ208-05	
Red	NJ208-02	
Royal	NJ208-01	



Sof-Gear

Chin Cup Headcaps

Sof-Gear Chin Cup Headcaps

Ultra-comfortable and effective headcaps have chin cups attached with Velcro®. Headcap and chin cup assembly available as a set or as separate components.

5/pkg. - Royal blue only

	Junior	Regular
Sof-Gear chin cup with headcap	SOF-CCJ	SOF-CCR
Sof-Gear headcap	SOF-HPJ	SOF-HPR
Sof-Gear chin cup (one size)	SOF-CC	





G&H® Orthodontics

PARAGON™ INSTRUMENTS

FEATURES INCLUDE:

- Tungsten Carbide inserted tips on all cutters for extremely high durability and superior performance. The tips may be replaced over time at a fraction of the cost of replacing the entire instrument.
- Surgical grade 420-Barstock stainless steel handles and stocks designed to withstand the rigors of repeated sterilization while maintaining their aesthetic finish.
- Diamond-honed cutting edges that stay sharp longer and are precisely aligned, making for a highly efficient, long lasting wire cutter.
- All Paragon™ Instruments are 100% solid stainless steel and are hand finished to a satin luster. In addition to corrosion resistance, this non-glare surface is easy to clean and will always look great.
- Precision-machined components, combined with our exclusive orbit forming process, create a smooth working hinge without shins, and keep the instrument's tips in proper alignment. With regular lubrication, joints will work smoothly for years.
- The sizes, shapes, handle lengths, and weights are optimized for comfort and confidence.



Paragon™ pliers are proudly made in the U.S.A.

Mini Distal End Safety Hold Cutter with T.C.

Safely cuts and securely holds distal ends of arch wires. Precise cutting edges and tip angle allow arch wires to be cut close to the distal end of buccal tubes.

Maximum Cutting Capacity

Rectangular wire up to .021" x .025"
(0.56 x 0.71mm)

Round wire up to .020" (0.51mm)

Ea.

IPL1-002



Flush Cut Distal End Cutter with T.C.

The flush cut feature allows the archwire to be cut flush with the end of the buccal tube, eliminating the possibility of patient discomfort resulting from archwire protrusion.

Maximum Cutting Capacity

Archwire up to
.021" x .025" (0.56 x 0.64mm)

Ea.

IPL1-003



Hard Wire Cutter with T.C.

T.C. inserts for extra hardness to ensure precision cutting of archwires or pins.

Maximum Cutting Capacity

Rectangular wire up to .022" x .028"
(0.56 x 0.71mm)

Round wire up to .020" (0.51mm)

Ea.

IPL1-006



Pin and Ligature Cutter with T.C.

This cutter is designed for easy and efficient cutting of pins and ligatures. The cutting edges are diamond-honed.

Maximum Cutting Capacity

Soft wire up to .015" (0.40mm)

Ea.

IPL1-005



Tweed Style Arch Forming Pliers

This plier is ideal for bending square and rectangular wire. Edges are radiused and hardened to prevent wire scoring and to preserve a smooth contact area with the wire. Blades are parallel when opened to .010 to ensure accurate 90° bends.

Bends wire up to

.022" x .028" (0.56 x 0.71mm)

.075" (1.9mm) Ea.

IPL1-009

.050" (1.2mm) Ea.

IPL1-010



Weingart Utility Pliers

Special features incorporated in Paragon™ Weingart style pliers make this one of the most popular. Matching serrated tips hold wires firmly at a convenient working angle. Carefully tapered beaks fit easily between brackets and are rounded for safety and comfort.

Holds wire up to

.022" x .028" (0.56 x 0.71mm)

Ea.

IPL1-013



Weingart Utility Pliers (Slim)

An efficient utility plier similar to model IPL1-013 but with specially designed narrow tips for better intraoral accessibility.

Holds wire up to

.022" x .028" (0.56 x 0.71mm)

Ea.

IPL1-012



Weingart Pliers (Angled)

Similar to the IPL1-013 but with 45° angled tips. Matching serrated tips hold wires firmly at a convenient working angle.

Holds wire up to

.022" x .028" (0.56 x 0.71mm)

Ea.

IPL1-014



HOW Utility Pliers

A versatile utility plier with long tapered tips. The 2.0mm diameter tips are serrated to prevent slippage. The tips are rounded for patient comfort and safety.

Ea.

IPL1-015



HOW Utility Pliers (Angled)

Similar to the IPL1-015 but with 45° angled tips and 2.0mm gripping pads for convenient access to lingual and other difficult to reach areas.

Ea.

IPL1-016



Jaraback Pliers

Ideal for precise bending of light wires. Precision grooves assure accurate bending and closing loops. Flat tip is serrated for firm gripping.

For wires up to

.020" (0.51mm)

Ea.

IPL1-017



Three Jaw Pliers

Precision aligned tips are gently rounded for consistent contouring and bending without damaging the archwire. One-piece construction of the double tip ensures superior strength.

For wires up to

(.036" (0.91mm)

Ea.

IPL1-020



Tweed Loop Forming Pliers

Ideal for making consistent, uniform loops. Tip has three sections of .045", .065", and .090" with matte finish to prevent wire slippage.

For use with round and square wires up to

.021" x .025" (0.55 x 0.64mm)

Ea.

IPL1-021



Posterior Band Removing Pliers

The plastic pad rests on the occlusal surface of the molar, which places the removing tip in the perfect position to catch the gingival edge of the band.

Ea. **IPL1-022**
Replacement plastic pads, **IRT1-01**
3/pkg.



Adhesive Remover Pliers

Designed to remove direct bond brackets quickly and comfortably. The plastic pad rests against the incisal/occlusal edge of the tooth to provide leverage. The sharp tip fits under the bracket flange. Can also be used to remove remaining adhesive.

Ea. **IPL1-023**
Replacement plastic pads, **IRT1-02**
6/pkg.



Bird Beak Pliers

The most popular and versatile pliers for working with round wire up to 0.30" (0.76mm) in diameter. The round beak is precision ground to a perfect cone, .025" (0.64mm) at the tip. The beaks are parallel at .020" (0.51mm) opening.

Long Tips Ea. **IPL1-026**
Short Tips Ea. **IPL1-027**



Light Wire Pliers

Longer, more gradually tapered beaks than the Bird Beak Pliers (IPL1-027). The longer beaks make it easier to bend small diameter loops.

For wires up to .016" (0.41mm)
Long Ea. **IPL1-030**



Direct Bond Bracket Removing Pliers (Angled)

Designed for fast, safe and comfortable removal of direct bond brackets. The angled tip allows for easy access to difficult anterior and posterior areas.

Ea. **IPL1-035**



Hook Crimping Pliers

Designed to crimp auxiliary stops, hooks and posts to archwires. The slotted design fits over the base of the hook while holding it tight during crimping.

Ea. **IPL1-042**



Stop "V" Bend Pliers

Designed for making 1 mm "V" bends to shorten archwires or provide a positive stop.

For wires up to .019" x .025"
Ea. **IPL1-045**



Wire Contouring Pliers

The smooth inner surface allows for subtle contouring and forming of archwires. Forms without scoring or torquing. Perfect for accentuated curves.

For wires up to .022" x .028" (.025 x .071mm)
Ea. **IPL1-048**



Hollow Chop Pliers

This contouring plier's mated concave and convex jaws are useful in reshaping archwires and forming palatal arches.

For round wire .014" - .036"
For rectangular wire .022" - .028"
Ea. **IPL1-049**



Finishing Pliers

Special double-sided offset head forms bayonet bends. Forms right-hand or left-hand step-up or step-down bends. For wires up to .021" x .025"

1/4 mm Ea. **IPL1-051.025**
1/2 mm Ea. **IPL1-051.050**
3/4 mm Ea. **IPL1-051.075**
1 mm Ea. **IPL1-051.100**

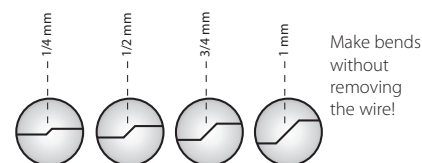

Schure Band Seater

This double ended instrument has a square and serrated end for pushing and seating molar bands, and a scaler on the opposing end for cleanup or removal of adhesives and cements. One-piece construction provides for durability and thorough sterilization. Serrated handle for firm grip.

Autoclavable up to 370°F/188°C

Ea. **ISP-042**



Band Seater

Simplifies cement cleanup and band adaptation. The seating tip is serrated on four sides and end.

Autoclavable up to 370°F/188°C

Ea. **BSEAT**



Mershon Band Pusher

Used for seating and burnishing bands into their final position. The squared and serrated tip provides a secure grip on band attachments, while the large handle provides for the firmest grip possible. One piece fabrication provides durability and complete sterilization.

Ea. **ISP-046**



Double Ended Ligature Director

This instrument is very useful when tucking or pushing elastics. The dual straight and curved ends allow for ease of intraoral placement and use. Solid stainless steel.

Autoclavable up to 370°F/188°C

Ea. **ISP-044**



Ligature Tier

This instrument is designed for faster and easier placement of elastic ligature ties on all styles and sizes of edgewise brackets. The smooth, rounded tips will not damage or cut elastomeric ligatures. Solid stainless steel.

Autoclavable up to 370°F/188°C

Ea. **ISP-045**



Explorer

This double ended explorer is helpful when removing elastic chain and ligature ties. The tips are very durable. Tempered stainless steel.

Autoclavable up to 370°F/188°C

Ea. **ISP-072**



Distal Bender

Cinchback bends are quick and easy. Simply insert the tip over the distal end of the archwire and twist in the desired direction. Straightening cinchback bends are done with equal efficiency, thus reducing the time required for changing the archwires.

Autoclavable up to 370°F/188°C

Single-ended, Ea. **ISP-108**
Double-ended, Ea. **DEDEBEND**



Force Gauge Dynamometer

Precisely measures forces exerted by elastics, archwires, and coil springs. Double-ended calibrated shaft. Supports a force range of 28-450 grams.

Ea. **ISP-352**



Standard Bracket Holder

Reverse action holds brackets and tubes without finger pressure for easier bonding.

Autoclavable up to 370°F/188°C

Ea. **ISP-048**



Fine Tip Bracket Tweezer

Fine, angled tips allow for precise positioning. Light reverse action allows for easy removal of the instrument after placement of the attachment.

Autoclavable up to 370°F/188°C

Ea. **ISP-056**



Deluxe Bracket Holder

This reverse action stainless steel tweezer holds brackets and buccal tubes with thin, angled tips which are designed to slip under bracket and tube tie wings. It is ideal for miniature attachments.

Autoclavable up to 370°F/188°C

Ea. **ISP-057**



Bracket Holder with Bracket Aligner

Reverse stainless steel tweezer incorporates a bracket aligner on the opposite end. This double ended instrument makes correct bracket placement easier by using the alignment tip in the archwire slot and adjusting alignment. It can also be used for flash removal.

Autoclavable up to 370°F/188°C

Ea. **ISP-060**



Keat Buccal Tube Tweezer

The curved body of the tweezer provides an unobstructed view for easy and precise placement of buccal tubes.

Autoclavable up to 370°F/188°C

Short handle, Ea. **ISP-070**
 Long handle, Ea. **KBTPLG**
 Reverse action, Ea. **KBTPSHR**



Mosquito Hemostat

This locking hemostat has extremely fine tips for the engagement of ligature and chain elastics. The stainless steel has an aesthetic brushed satin finish.

Autoclavable up to 370°F/188°C

Ea. **ISP-055**



Mosquito Hemostat with Hook

Similar to the standard version, but with a hook at the tip to avoid slippage when engaging elastic ties and chain. Tempered steel tip for strength and durability.

Autoclavable up to 370°F/188°C

Ea. **ISP-062**



Mathieu Hemostat

Features small, highly serrated tips with the addition of a hook at the tip designed to avoid slippage when engaging elastic ties and chain. With Tungsten Carbide inserts.

Autoclavable up to 370°F/188°C

Without Hook, Ea. **ISP-996**
 With Hook, Ea. **ISP-996H**
 Narrow w/o Hook, Ea. **MNHNT**



Separating Plier

This instrument is designed to stretch separating elastics for ease of placement between tooth contacts. The curved beaks allow for easy use in the posterior segment.

Autoclavable up to 370°F/188°C

Ea. **ISP-050**



Boone Gauge

This positioning device allows the orthodontist to precisely gauge proper bracket height during placement. (3.5, 4.0, 4.5, 5.0)

Metal - autoclavable up to 370°F/188°C.

Ea. **SSBRACG**



Bracket Height Gauge

Incorporates a precision bar to seat in archwire slot at 3.5, 4, 4.5, or 5mm distance from occlusal rest to accurately position brackets during bonding. Made of aluminum. Available in .018 or .022 versions.

.018 ea. **BRKTPOS018**
.022 ea. **BRKTPOS022**



Posterior Bond Placer

Designed for precise placement of posterior bonded attachments. Anodized aluminum with a small head to allow a wide field of vision. Serrated tips.

Ea. **BRPL050S**



FRC Placement Tool

A double-ended spatula that is angled for ease of application and curing of FRC bonded lingual retainers and splints.

Ea. **PLACE**



Therma-Stick™

A hollow tube with a special tip that is filled with water, then frozen. Place the frozen tip against NiTi wire (particularly M5™ Thermal NiTi) to soften the wire for easy engagement in the bracket. May be used directly in the patient's mouth.

Ea. **THSTK**



Fine tip enhances wire contact between brackets.

Bite Stick

This high-heat bite stick is compatible with any conventional sterilization method, including Dry Heat up to 350°F. Serrated stainless steel insert ensures positive contact without slipping.

Ea. **BSHH100**



Bite Stick

Manufactured from a high impact plastic similar to stainless steel. Will not flex or bend like traditional bite sticks. Autoclavable up to 260°.

Light Green Ea. **TS-1G**
Teal Ea. **TS-1T**
Cobalt Blue Ea. **TS-1CBN**
Orange Ea. **TS-1OR**
Red Ea. **TS-1RED**
Purple Ea. **TS-1P**



Bite Stick - Hi Heat

Manufactured from FDA allowable plastic that will withstand temperatures up to 370°.

Blue Ea. **TS-1ST**



Bite Stick - Super Hi-Heat

Manufactured from FDA allowable plastic that will withstand temperatures up to 600°.

Tan Ea. **TS-1SS**



White Acrylic Plier Rack

Ea. **1009**

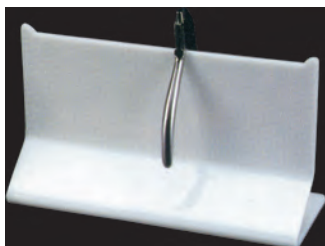

Dual Plier Rack

Ea. **1010**

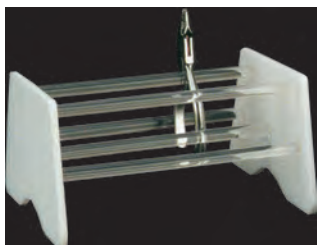

Single Plier Rack

Ea. **1011**

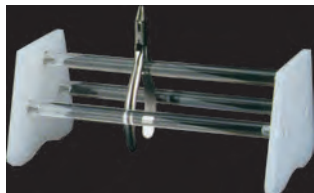

Acrylic Instrument Rack

Ea. **1012**

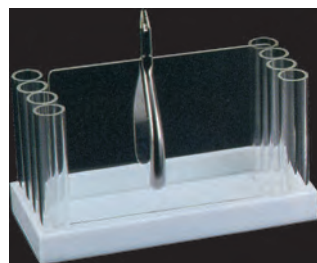

Plier Rack

Our Plier Rack neatly organizes most any orthodontic plier sets. Aluminum rods with plastic ends allow for easy wipe down. Holds approximately 20 instruments.

Ea. **PLRK020**



Combination Plier Rack

This beautiful rack accommodates 7 pliers, and also has 7 vertical storage holes for explorers, mouth mirrors, mosquito, and Mathieu instruments. The open front area is also ideal for instruments and auxiliaries.

Ea. **S413-01**



Round Instrument Holder

This durable, clear Lucite 4" cylinder easily holds up to 15 pliers, while an inner 1 1/4" cylinder stores narrow instruments such as scalers, explorers, and band seaters.

Ea. **S411-01**



Instrument Stain Remover

Powder formula removes stains, tarnish and restores luster.

Ea. **3-740**



Ordering online is quick and easy!



- How do I get started?
 - 1) Activate your account for online access - GHOrthodontics.com/activate
 - 2) Set your password
- Quick Reorder – Reorder products with just a few clicks
– View 2-year order history
- Add product samples quickly to your order
- Updated product sections for easier ordering
- View latest product videos, brochures and catalogs



Lavoric® Surgical Milk

A concentrated pre-autoclave dip that extends the life of valuable instruments. The non-toxic, odor-free formula inhibits rust and lubricates all hinged instruments.

Quart **862-2310**
Gal. **862-2312**



L&R

Barrier Milk

Helps prevent corrosion of instruments when used prior to sterilization. Provides complete protection from rust and keeps hinged instruments moving smoothly.

8 oz. spray **00139**
Gal. **076**



Spring Measuring Gauges

Our exclusive TAD and CC **Spring Measuring Gauges** determine the spring size and force value needed. Landmark extensions are highlighted in red on side (A) and corresponding spring suggestions are on side (B). The hole in the gauge represents a spring eyelet or ligature and can be engaged over a hook or TAD screw to accurately measure distance between anchor points.



20/box
CC measuring gauge **CCOFMG**
TAD measuring gauge **CCOTMG**

Millimeter Ruler

Our unique double-sided 60mm or 80mm rulers feature a hole to engage a post or hook making space measurement quick, easy and accurate.

20/box
60mm ruler **RULRMG**
80mm ruler **RULRMGG**

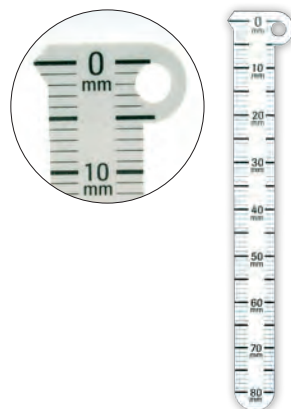

Overbite Ruler

This aluminum ruler makes for easy measuring of overbite.

Ea. **OP-11-00**



Digital Caliper

Precise measurements with easy-to-read digital display. Durable stainless steel construction, metric/Inch change over (true conversion), zero setting (zero setting at any position within the measuring range), measures external and internal dimensions, depth, and steps. Comes fully assembled and ready to use - also includes (1) replacement battery and instructions.



Ea. **DIGICALIP**

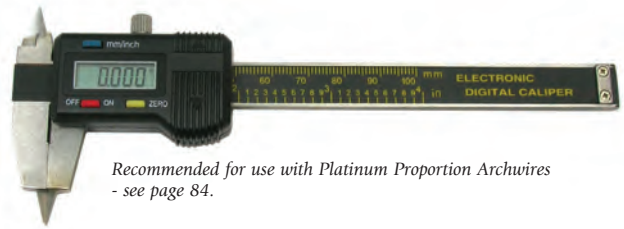

Recommended for use with Platinum Proportion Archwires - see page 84.

Silicone

Instrument Code Rings

Suitable for all sterilization processes.
60/pkg. Regular 1/8" Large 1/4"
Hand Instruments Pliers & Cutters
Aqua **202CD-4X** **205CD-4X**
Dark Blue **202CD-2X** **205CD-2X**
Mauve **202CD-10** -
Neon Yellow **202CD-3N** **205CD-3N**
Red **202CD-5N** **205CD-5N**
White **202CD-1** **205CD-1**



Code Ring Kits - Assorted colors

Hand Instruments
Regular - 80 pieces **202CD-A**
Pliers & Cutters
Large - 80 pieces **205CD-A**

110v Warm Air

Tooth Dryer

Removes excess tooth surface moisture.

Ea. **300-501**
Nozzle with elbow - Ea. 300-503
Dryer elbows - Ea. 300-504



Low-Speed

Contra Angle Full 360° Swivel 1:1

Fully autoclavable.

Ea. **111-0050**

Note: Not available for Canadian shipment.



Hi-Speed

Air King Push Button Handpiece

Ea. **120-0344**

Note: Not available for Canadian shipment.



Hi-Speed

Air King Mini Push Button Handpiece

Ea. **120-0344M**

Note: Not available for Canadian shipment.



Hi-Speed

Air King Regular Handpiece

Ea. **120-0360**

Note: Not available for Canadian shipment.



Hi-Speed

Air King Mini Standard Regular Handpiece

Ea. **200-0030**

Note: Not available for Canadian shipment.



High/Low Speed

Handpiece Lubricating Pen Oiler

Autoclavable & non-toxic lubricating oil. 1/4 oz. pen oiler.

2/pkg. **130-2172**



Once-A-Day

Handpiece Lubricant

Ea. **932-9800**



premier 2pro® Disposable

Prophy Angles

2pro's unique 2-in-1 design guarantees total access to all tooth surfaces. Patented gearless design ensures quiet, smooth-running, vibration-free operation with less heat build-up. Latex-free.



Soft/Short Cup (purple cup, short tip) 144/bag **5500301**

Firm/Short Cup (blue cup, short tip) 144/bag **5500302**

Soft/Long Cup (white cup, long tip) 144/bag **5500303**

Firm/Long Cup (green cup, long tip) 144/bag **5500304**



Disposable

Prophy Angles

Non-latex.

Firm - 100/pkg. **9539170**

Soft - 100/pkg. **9539850**

Super Soft - 144/pkg. **9539650**



Disposable

Prophy Angles

Non-latex.

Soft - 100/pkg. **953-3590**

Hard - 100/pkg. **953-3598**



Twist Prophy Angles

100/pkg.

Firm **TPAFC**

Soft **TPASC**

Tapered Brush **TPATB**



Sparkle Prophy Angles

Firm Cup White - 500/pkg. **TPASFC5**

Soft Cup Lavender - 100/pkg. **TPASSC1**

Firm Cup White - 100/pkg. **TPASFC1**

Soft Cup Lavender - 500/pkg. **TPASSC5**



Prophy Cups

144/pkg.

Screw Type

Firm **9539400**
Soft **9539820**

Knob Type

Firm **9539450**
Soft **9539810**
Superflex **9539620**



Latch-Type

Prophy Cups

144/pkg. **24-40514**



Gelato

Prophy Paste

200/pkg.

Coarse Grit / Fruit **24-02777**
Coarse Grit / Mint **24-03077**
Medium Grit / Fruit **24-02677**
Medium Grit / Mint **24-02277**



Assorted fruit flavors consist of: Bubble Gum, Cherry, Mint, Pina Colada, Orange Sherbet, Raspberry.

Plak Smaker

Brilliance Prophy Paste

No fluoride or flavor.

200/pkg. **10664**



Looking for
clinical
supplies?

You'll find what you need in our
full line of quality products!

From lab supplies to clinical treatment products,
G&H offers more than 6,000 brand-name items and precision
G&H manufactured products.

Order online at: GHOrthodontics.com

premier Enamel Pro®

Prophy Paste

Enamel Pro contains 1.23% fluoride ion.
200/box

Chocolate Hazelnut

Fine **9007628**
Medium **9007632**
Coarse **9007633**

Mixed Berry

Fine **9007630**
Medium **9007627**
Coarse **9007631**

Strawberry

Fine **9007607**
Medium **9007608**
Coarse **9007609**

Grape

Fine **9007610**
Medium **9007611**
Coarse **9007612**

Bubblegum

Fine **9007614**
Medium **9007615**
Coarse **9007616**



RaspberryMint

Fine **9007620**
Medium **9007621**
Coarse **9007622**

VanillaMint

Fine **9007617**
Medium **9007618**
Coarse **9007619**

Mint

Fine **9007600**
Medium **9007601**
Coarse **9007602**

Without Fluoride

Mint **9007613**
Coarse **9007613**

Individual Cups

Sparkle "Free" Prophy Paste

Fluoride-FREE, Dye-FREE, Gluten-FREE
200/pkg.

Medium grit / fruity gum **UPSFMF**
Medium grit / spearmint **UPSFMS**



Individual Cups

Pumice Preppies

Contains no flavoring agents,
oils or fluoride. Leaves no residue. 2g
cups.

100/pkg. **03400**



premier Comfy-grip™

Prophy Cup Holder

Ergonomic cup holders for use with
most prophy-paste cups and fluoride
varnish applications. Autoclavable.

3/pkg. **9007650**



Fine/Medium/Coarse

Pumice

Medium / 3.5 lb. Jar **03476**
Coarse / 3.5 lb. Jar **03417**



Green

Mounted Stones

Silicon carbide grit: fast, cool cutting, economical to use, excellent durability.

12/pkg.

Points I-5	1631194
Points T-4	1631196
Points P-2	1631199
Points W-3	1631200
Points W-6	1631201
Points F-2	1631203
Points I-3	1631205

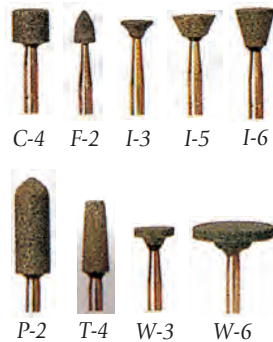

Reliance®/Renew System

Burs & Points

18 fluted friction grip mounted and designed to be the quickest, safest, method for bulk removal of all types of bonding adhesive after bracket removal. Ea.

Bur #118S	RSB
Bur #218	RSB2
Bur #118L	RSBL
Bur #815	RSB815

Ball shaped ideal for lingual surface.

Bur 118S



Short cutting surface with rounded end.

Bur 118L



Long cutting surface with rounded end.

Bur 218



Long tapered cutting surface.

Reliance®

Points

Will remove thin layers of adhesive, clean and polish the enamel with no damage. 12/pkg.

Point #383	RSPFG
Friction Grip (high-speed)	RSPHP
Straight Handpiece (slow-speed)	RSPL
Latch	



Silver Carbide Burs

Ea.

88A Carbide Bur	1201820
51A Carbide Bur	1201930
84T Carbide Bur	1201830
52D Carbide Bur	1201910
82T Carbide Bur	1201850
33C Carbide Bur	1201980

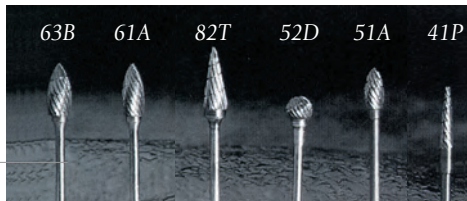

Carbide

Lab Cutter

Ea.

Coarse Cross-Cut	406001
Coarse Cross-Cut	406102
Coarse Cross-Cut	406302
Coarse Cross-Cut	406801
Coarse Cross-Cut	406901
Coarse Cross-Cut	407001
Medium Cross-Cut	302001
Medium Cross-Cut	302302
Medium Cross-Cut	302801
Medium Cross-Cut	303001
Medium Cross-Cut	303101
Fine Cross/Spiral Cut	700801
Medium Spiral-Cut	101001

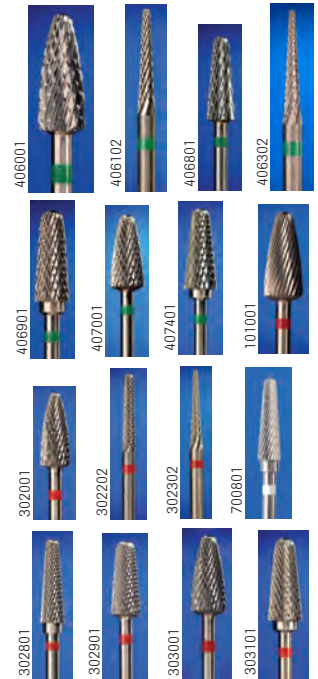

Alpen

Swiss Diamond Burs



Esthetic Finishing Burs - 5/pkg.

133.010.4 Fine Finishing Bur
134.014.6 Fine Finishing Bur

R133F010FG
R134F014FG



Football Pointed Burs - 5/pkg.

368.020.5 Fine Football Pointed Bur
368.023.5 Coarse Football Pointed Bur

R368F020FG
R368C023FG



Football Burs - 5/pkg.

379.016.3.5 Coarse Football Bur
379.016.3.5 Fine Football Bur
379.018.3.5 Coarse Football Bur
379.018.3.5 Fine Football Bur
379.023.5 Coarse Football Bur
379.023.5 Fine Football Bur

R379C016FG
R379F016FG
R379C018FG
R379F018FG
R379C023FG
R379F023FG



Round Wheel Burs

909-1.5.040.1.5 Coarse Rnd. Wheel - 5/pkg.
909-1.040.1 Coarse Rnd. Wheel - 5/pkg.

R90915C040FG
R9091C040FG



Note: Not all Burs are available for Canadian shipment.

premier Two Striper®

Interproximal Diamond Bur

Thin-shaped diamond for breaking interproximal contact. Minor diameter 0.3mm, major diameter 1.5mm, abrasive length 5mm. Fine grit.
5/pkg. **2015054**



premier Solo™

Interproximal Diamond Bur

Always sharp, each diamond is engineered to provide a superior cut. Solo is pre-sterile to ensure convenient organization and workflow efficiency for you and your staff. Major diameter 1.5mm, abrasive length 5mm. Medium grit.
25/box **292016M**



Gold Trimming and Finishing Burs

10/pkg.
Flame - Diameter 1.2 **7102**
Flame - Diameter 1.4 **7104**
Flame - Diameter 1.8 **7106**
Needle - Diameter 0.9 **7901**
Needle - Diameter 1.0 **7902**
Needle - Diameter 1.2 **7903**
Bullet - Diameter 1.0 **7802**



Gold Metal Cutting Carbide Burs

10/pkg.
Round-End Fissure - Dia. 1.0 **G/1557**
Round-End Fissure - Dia. 1.2 **G/1558**



Gold Carbide Burs

Ea.
84T Carbide Bur **1202305**
82T Carbide Bur **1202335**
63B Carbide Bur **1202320**
88A Carbide Bur **1202300**
41P Carbide Bur **1202355**

- Gold Colored
- Titanium Nitride Coating
- Low Speed Carbide Burs
- Faster Cutting
- Longer Lasting

Diamond Burs - Wheel Shaped

10/pkg.
Med., Round Wheel - 4.0 Dia. **314068524040**



Diamond Burs - Interproximal

10/pkg.
Fine, Interproximal, 1.6 Dia. **314465514016**



Diamond Burs - Needle Shaped

10/pkg.
Coarse, Med. Needle, 1.8 Dia. **314166534018**
Fine, Long Needle, 1.4 Dia. **314167514014**



Diamond Burs - Football Shaped

10/pkg.
Fine, Football-Shaped, 1.4 Dia. **314257514014**
Fine, Football-Shaped, 1.6 Dia. **314257514016**
Medium, Football-Shaped, 1.6 Dia. **314257524016**
Medium, Football-Shaped, 1.8 Dia. **314257524018**
Coarse, Football-Shaped, 2.3 Dia. **314257534023**



Diamond Burs - Flame Shaped

10/pkg.
Medium, Flame-Shaped, 1.6 Dia. **314243524016**
Medium, Flame-Shaped, 1.8 Dia. **314243524018**



Diamond Burs - Round Shaped

10/pkg.
Fine, Round-Shaped, 1.8 Dia. **314001514018**
Fine, Round-Shaped, 2.1 Dia. **314001514021**



Anterior ARS Diamond Bur

Use for rapid enamel reduction
5/pkg. **55000**



Posterior ARS Cross-Cut Carbide Stripping Bur

Use for rapid enamel reduction
5/pkg. **699LC**



Note: Not all Burs are available for Canadian shipment.

Diamond Discs & Cutters

Great for enamel reduction, shaping and interproximal stripping.

Ultra Flex Cutter - Ea.

.17mm **1290690**
.20mm **1290700**



Mini Flex Cutter - Ea.

.10mm **1290695**

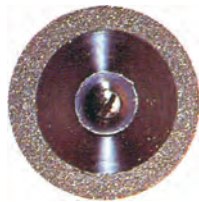

Kool Flex Cutter

Ea. **1290710**
.17mm

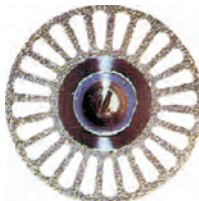

Flex Edge (Abrasives Both Sides)
Ea. **DISCDSM**

(Disc comes with mandrel)



SuperFlex Edge (Abrasives Both Sides)
Ea. **910S-220**



Flex Edge (Abrasive Up)
Ea. **DISCSSUM**

(Disc comes with mandrel)



SuperFlex Edge (Abrasive Up)
Ea. **912S-220**



Flex Edge (Abrasive Down)
Ea. **DISCSSDM**

(Disc comes with mandrel)



Diamond Disc (Double Sided - w/o Mandrel)
Ea. **DISCDS**



Diamond Disc (Single Sided - includes (1) Mandrel)
2/pkg. **DISCSS**



SuperFlex Edge (Abrasive Down)
Ea. **913S-220**



Flex Full (Abrasive Up)
Ea. **916F-220**



SuperFlex Full (Abrasive Up)
Ea. **916S-220**



Flex Full (Abrasive Down)
Ea. **917F-220**



SuperFlex Full (Abrasive Down)
Ea. **917S-220**



Flex Full (Abrasive Both Sides)
Ea. **927F-220**



SuperFlex Full (Abrasive Both Sides)
Ea. **927S-220**



Econo Cutter - Ea.

2 1/2" **1300480**
4" **1300500**

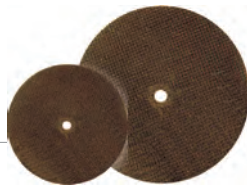

Wheel Saw - Ea.

Raintree **18320**
Proform **9630100**



Diamond Disc
Safety Guard

Ea. **DISCGD**



Diamond Disc
Mandrels

5/pkg. **DISCMAN**



Scotch-Brite®
Polishing Brushes

Ideal for polishing edges of plastic appliances.

12/pkg.
Fine **1670091**
Medium **1670092**
Coarse **1670016**



Flexiview
Interproximal Strips

10/pkg.
Single-sided, 5 7/8" long x 0.13mm thick
Medium grit, Narrow **5VNM1**
Medium grit, Wide **5VWM1**



Dual Sided - Abrasive both sides

Lightning Strips

.30 mm thick x 5 7/8" long

2mm/Fine, 10/pkg. **630-81330**
3mm/Fine, 10/pkg. **630-81350**
4mm/Fine, 10/pkg. **630-81370**

2mm/Medium, 10/pkg. **630-81390**
3mm/Medium, 10/pkg. **630-81410**
4mm/Medium, 12/pkg. **LSDSM4M**
6mm/Medium, 12/pkg. **LSDSM6M**
8mm/Medium, 12/pkg. **LSDSM8M**

3mm/Coarse, 10/pkg. **630-81470**
4mm/Coarse, 10/pkg. **630-81490**



Single Sided - Abrasive one side

Lightning Strips

.21 mm thick x 5 7/8" long

2mm/Fine, 10/pkg. **620-81010**
3mm/Fine, 10/pkg. **620-81030**
4mm/Fine, 10/pkg. **620-81050**

2mm/Medium, 10/pkg. **620-81070**
3mm/Medium, 10/pkg. **620-81090**
4mm/Medium, 12/pkg. **LSSSM4M**
6mm/Medium, 12/pkg. **LSSSM6M**
8mm/Medium, 12/pkg. **LSSSM8M**

3mm/Coarse, 10/pkg. **620-81150**
4mm/Coarse, 10/pkg. **620-81170**



Stainless Steel
Lightning Strip Handle

Full stainless steel, durable and sterilizable. Securely holds lightning strips for controlled reduction.

Ea. **INTPRXHNDL**

Discover Your Orthodontic Buying Power!
Your membership in the G&H OrthoClub® results in big savings. Enjoy buying-group savings on more than 6,000 brand-name clinical supplies including G&H manufactured products.

Size 1

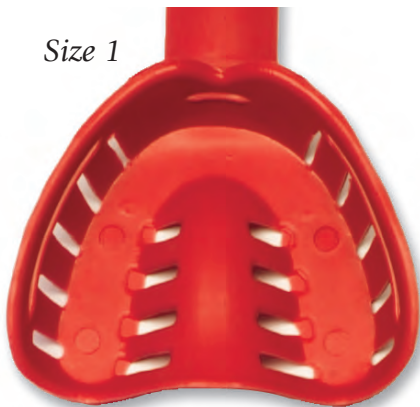

Size 2



Size 3



Size 4



Size 5



Lower trays correspond to the uppers in size and color.

Colors may vary slightly from illustration.

Size 6



G&H® Disposable Impression Trays

G&H® trays are rigid, color-coded anatomical plastic trays with perforation strips that offer economical use and disposability. Long handles provide sure grip while retention slots secure alginate without need for adhesives. They are available in size 1 (smallest) through size 6 (largest); size is imprinted on handle.

Box of 25/single color, upper or lower

	Size	Color	Upper	Lower
Smallest	1	Red	DITU0125	DITL0125
	2	Orange	DITU0225	DITL0225
	3	Blue	DITU0325	DITL0325
Largest	4	Green	DITU0425	DITL0425
	5	Yellow	DITU0525	DITL0525
	6	Purple	DITU0625	DITL0625

Box of 50/single color, upper or lower

	Size	Color	Upper	Lower
Smallest	1	Red	DITU01	DITL01
	2	Orange	DITU02	DITL02
	3	Blue	DITU03	DITL03
Largest	4	Green	DITU04	DITL04
	5	Yellow	DITU05	DITL05
	6	Purple	DITU06	DITL06

Disposable

Impression Trays

Trial pack. (6) sizes - (5) trays of each size upper and lower
Box of 60

DITAS



Disposable - Footed

Impression Trays

Box of 50/single color, upper or lower

Size	Color	Upper	Lower
Pedo (S)	Red	GIT-U5	GIT-L5
Pedo (M)	Orange	GIT-U4	GIT-L4
Small	Blue	GIT-U3	GIT-L3
Med.	Green	GIT-U2	GIT-L2
Large	Yellow	GIT-U1	GIT-L1



Stainless Steel

Impression Trays

G&H® Edge-Lok™ Impression Trays are designed to create consistently accurate and distortion free impressions. They are manufactured from highly polished stainless steel and feature a rolled edge for positive retention of alginate. Edge-Lok™ trays are designed with wide, easy-to-grip handles and come in a range of sizes. They are compatible with ultrasonic, autoclave and dry heat sterilization methods.

Ea.



Non-perforated



Perforated

Perforated

	Size	Upper	Lower
Extra Small	5	TRAYXSU	TRAYXSL
Small	4	TRAYSU	TRAYSL
Medium	3	TRAYMU	TRAYML
Large	2	TRAYLU	TRAYLL
Extra Large	1	TRAYXLU	TRAYXLL

Non-Perforated

	Size	Upper	Lower
Extra Small	5	TRAYXSUNP	TRAYXSLNP
Small	4	TRAYSUNP	TRAYSLNP
Medium	3	TRAYMUNP	TRAYMLNP
Large	2	TRAYLUNP	TRAYLLNP
Extra Large	1	TRAYXLUNP	TRAYXLLNP

Utility Wax Strips

These wax strips are excellent for peripheral lining impression trays. 3/16" x 11", white.

75/box
450/box

UWX1164
700-117



premier® Triple Tray®

Impression Tray

Alginate full-arch closed-mouth impression tray. Simultaneously obtain maxillary and mandibular impressions - plus bite registrations. Ideal for fabrication of custom trays, tooth whitening trays, temporaries, study models, mouth guards/night guards, removable prosthetics and orthodontics. Can also be used with alginate substitute vinyl polysiloxane (VPS) material. Do not use a heavy body VPS material.

24/box

Small (purple)	1006313
Medium (white)	1006323
Large (green)	1006333
Assorted (5 sml, 14 med, 5 lrg.)	1006343



Kromopan® Alginate

KromoPan® has chromatic (color) indicators that tell you how long to spatulate (purple), when to load (pink) and when to insert into the patient's mouth (white). Total elapsed time from start to finish is just over 1 minute. Impression can be kept over 100 hours without distortion or shrinkage by simply rinsing and enclosing in a plastic bag.

(1) 1lb. bag

KRM302



Flavors can be added to improve patient acceptance.



See next page for our flavors!

Extra-Fast Set

OrthoPrint® Alginate

Fast water absorption, highly elastic alginate, easy mixing and homogenous mass, smooth, compact surfaces. Long impression storage at 5 year shelf life. 12 bags/case.

(1) 500g bag

C302145



Chromatic

Alginmax® Alginate

Chromatic indication of the working phases for easy and precise results, regardless of water temperature and hardness. Dust-free powder for safe working and cleaning ease.

(4) 1lb. bags

2802/1



Alginate Flavoring

Alginate Flavors make taking an impression more pleasant for the patient. Many patient pleasing flavors to choose from! 2 oz. bottles. Ea.

Apple	ALFLAP
Banana	ALFLBN
Blueberry	ALFLBL
Bubblegum	ALFLBB
Caramel	ALFLCA
Cherry	ALFLCH
Chocolate	ALFLCT
Cinnamon	ALFLCN
Cola	ALFLCO
Cookie Dough	ALFLCD
Cotton Candy	ALFLCC
Fruit Punch	ALFLFP
Grape	ALFLGR
Lemon	ALFLLM
Orange	ALFLOR
Peppermint	ALFLPP
Piña Colada	ALFLPC
Pineapple	ALFLPN
Raspberry	ALFLRS
Root Beer	ALFLRB
Strawberry	ALFLST
Watermelon	ALFLWM



Alginator II Mixer 110v

Makes a smooth, bubble-free mix while eliminating waste and reducing clean up time. Now with a single, speed and improved portability and ergonomics. Box contents include: White 110v Alginator, 1 Identical Dust-Free Fast Set Alginate (1 lb), 1 Gray Latex Free Alginate Bowl, 1 Clean & Lube Spray (4 oz), 1 Spatula. Ea. **25227**



Bowl For Alginator II Mixer

Medium - gray 3 3/8" x 5" **25236**
Large stone bowl - gray 4 1/2" x 5 3/8" **25252**



Spatula For Alginator II Mixer

Ea. **25234**



Sultan® Healthcare Genie® Impression Material

Ultra Hydrophilic Impression Material

Extra-Light Body
2-pack berry flavored, 2 x 50mL cartridges, 6 x 4.2mm mixing tips, 6 x intraoral tips. Rapid set (2:10) Ea. **77600**

Light Body
2-pack berry flavored, 2 x 50ml cartridges, 6 x 4.2mm mixing tips, 6 x intraoral tips. Rapid set (2:10) Ea. **77610**

Regular Body
2-pack berry flavored, 2 x 50ml cartridges, 6 mixing tips. Rapid set (2:10) Ea. **77620**

Heavy Body
2-pack berry flavored, 2 x 50ml cartridges, 6 x 6.5mm mixing tips. Rapid set (2:10) Ea. **77630**



Sultan® Healthcare Genie® Putty

Berry flavored. 2 x 300mL jars and 2 scoops. Rapid Set (2:30) **77650**
Standard Set (4:30) **77655**



Sultan® Healthcare Genie® Bite Registration

Mint flavored. 2 x 50ml cartridges, 6 mixing tips. Fast Set (0:90) **77640**
Super fast set (0:60) **77645**



Sultan® Healthcare Genie® Tray Adhesive

Liquid polyvinylsiloxane. 14 mL **77100**



Heraeus Kulzar

**Flexitime®
VPS Imp. Material**

Correct Flow -
2 to 1 cartridge - light body.
Includes: (2) 50mL cartridges,
(6) mixing tips, users guide
Ea. **50034806**

Refill pack: (12) 50mL cartridges,
(6) mixing tips
Ea. **66002186**

MonoPhase - medium body.
Includes: (2) 50mL cartridges,
(6) mixing tips, users guide
Ea. **50034811**

Refill pack: (12) 50mL cartridges,
(6) mixing tips
Ea. **66002200**

Dispensing Gun
High performance for VP
Ea. **VP-8202**



Heraeus Kulzar

**Flexitime®
Easy Putty**

Flexitime® is a vinylpolysiloxane
impression material that has a full
range of indications and a working
time from 1 to 2.5 minutes (total set
time 3.5 to 5 minutes). 600 mL tub.
Ea. **50034802**



Heraeus Kulzar

Flexitime® Bite

Vinylpolysiloxane bite registration that
is scannable for use with CAD system.
Ensures efficiency with a set time of
only 30 seconds.
Bulk pack, 50 mL, 6/box.
Ea. **66038751**



LuxaBite®

Bite Registration

LuxaBite is a rigid bisacryl bite
registration material that combines
superior handling properties and a
firmer set to yield the most accurate
and stable bite registrations on the
market.
Kit includes: (1) 50 mL, cartridge, 15
Automix-Tips.

Kit **110560**
Mixing Tips, 25/pkg. **110609**
Dispensing Gun **110411**



Sultan® Healthcare
Mixing Tips

Use with impression material and bite
registration. 48/pkg.

4.2 mm x 12 mm (Yellow) **72003**
6.5 mm x 12 mm (Green) **72001**



Alginate Spatulas

Ea.
Blue **9055A-2C**
Yellow **9055A-3C**
Green **9055A-4C**
Red **9055A-5C**
Pink **9055A-6C**
Purple **9055A-10C**
Orange **9055A-12C**



**Buffalo Spatulas/
Knives**

Flexible stainless steel blade
permanently riveted to a hand-rubbed
rosewood handle.

Ea.
3 1/2" **11R**
4 1/2" **4R**
1 1/2" Knife **6R**
1 1/2" Knife **7R**

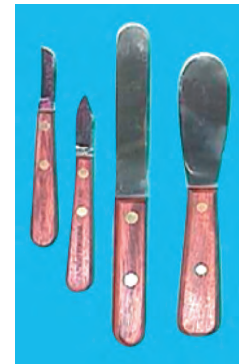

DisposaBowl®
**Disposable
Mixing Bowls**

The disposable mixing bowls will not
crack or break. It is microwavable and
great for heating very hot water and
for mixing resins. Using the disposable
mixing bowl keeps plumbing lines
clear and saves chair time.

50/pkg. **DISPOSABOWL**



Spectrum/Flowbowl
Green Mixing Bowls

Ea.
Large (600cc)
Amethyst **904MBL-10C**
Lt. Blue **904MBL-2C**
Green **904MBL-4C**
Yellow **904MBL-3C**



Flexibowls

Mixing Bowls

Ea. **1150070**
 Med. (350cc) **1150080**
 Large (600cc) **1150090**
 X-Large (850cc)



Rubber

Mixing Bowls

Manufactured from quality black, flexible rubber. 4 3/4" diameter.
 Ea. **1150030**



Whip Mix®

Foilcote

When applied to plaster or stone, it seals the pores and forms a smooth surface that gives excellent separation from the mold. Eliminates the time-consuming tinfoiling and resulting creases.

3.5 oz. **09687**
 Gal. **09709**



EZ-Sep

Separating Medium

8 oz. **RES008**



Wonderfill® Tongue Filler

Wonderfill requires no setup time and has no messy cleanup. After a lower impression is made, the tongue area is filled with Wonderfill. Plaster/stone is poured and sets, and then Wonderfill is removed for a perfectly clean model.

3.5 lb. **344**



Almore®

Blue Sheet Wax

Dead soft when heated - Extremely accurate bite registration. 3" x 6" sheets

1 lb. **42600**

Blue Bite Tabs **42602**
 125/box



Bite Wax Sheets

These wax sheets are made of pure beeswax. They are strong, smooth and non-sticky for excellent bite registration. Scored to break apart easily. 3" x 6" x .060"

1 lb. box **BWX021**



Aluwax®

Impression Wax

50/box **DF-006**



Aluwax®

Waxed Cloth

Ea. **WCF-005**



Smoothex®

Debubblizer

Surface tension reducing liquid.

8 oz. w/Pump **02313**

16 oz. **09849**

34 oz. **29394**



Russman®

Debubblizer

8 oz. **RDS8**

32 oz. **RDS32**



Cadco®

Clean & Lube Spray

Used on alginate bowls between mixes for cleaning and reducing bowl abrasion.

4 oz. **23070**



Alginate Remover

Removes alginate materials from nickel, chrome, steel and plastic impression trays. Two ounces of concentrated powder yields one quart of solution.

2 oz. **240**



Bosworth Tac™ Tray Adhesive Spray

TAC™ securely holds the alginate in the tray when the impression is removed from the patient's mouth. TAC™ is alcohol-based for faster drying and easier clean-up and can be dissolved with isopropyl alcohol.

3.5 oz. **0921880**



Coe® Tray Cleaner

Mixes easily with water to remove alginate, wax and material compounds from metal trays and instruments. Cleans in as little as 15 minutes.

575g **250010**



Non-Irritating Orange Solvent

32 oz.
21002



Whip Mix® Stones & Plasters Cont.

Micro Stone
Gold 50 lb. **31763**

Ortho Stone
Super Wht. 50 lb. **31801**

Snap Stone
Pink 50 lb. **33219**



Modern Materials® Stones & Plasters

Lab Stone
Buff 25 lb. **50046277**

Ortho Stone - Type III
White 25 lb. **50046972**



VIBRATOR TABLE
AVAILABLE ON
PAGE 157

PLASTER TRAPS
AVAILABLE ON
PAGE 158

Modern Materials® Stones & Plasters Cont.

Ortho Plaster - Type II
Snow wht. 25 lb. **50048170**



Non-Yellowing Model Glow Soap

Model glow gives an incredibly high luster to gypsum models. Its special formulation does not yellow or flake and seals the pores to provide a protective coating.

Gal. **29009**



Orthodontic Model Storage Boxes

Dimensions: 11.25" x 3.75" x 2.75"
Comes with 4 or 6 pocket divider.

25/box **610-071**

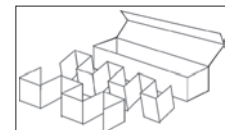

DeLar Split-Cast Large Formers

Includes surfactant and separating medium.

Kit **SCL020**



Acetate Tracing Paper

Cephalometric and panoramic, matte-finish .003" acetate tracing paper offers excellent pencil adhesion and dimensional stability. The non-curling edges maintain flatness. A matte side accepts pencil or pen markings with excellent contrast clarity. (8" x 10" Tablet (100 sheets)

Ea. **ATP100810G**



Photographic Mirrors - Glass

G&H® Premium Glass Photographic Mirrors offer unsurpassed quality and the finest possible color and image transfer. Manufactured of 3mm float glass double-sided coated with chromium for maximum reflective qualities. G&H® mirrors are the finest of their kind. They are compatible with autoclave sterilization.

(Premium glass mirrors are warranted for 5 years against peeling only. Damage caused by misuse is not warranted, i.e. breakage, scratches, chips or staining.)

- | | |
|----------------------|---------------|
| Ea. | |
| Extra-Large Occlusal | PRMRXL |
| Adult Occlusal | PRMRAD |
| Child Occlusal | PRMRCH |
| Lingual | PRMRLG |
| Buccal | PRMRBC |

Set of (4)
Includes all but PRMRXL **PRMRKT4**

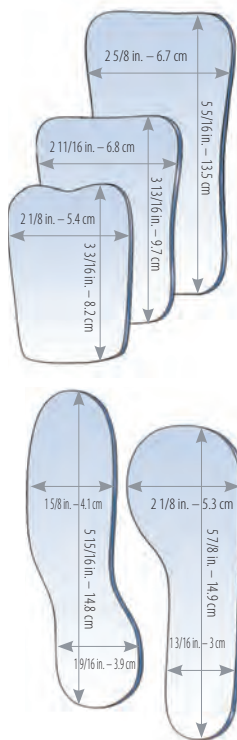

Angled Occlusal Mirror

G&H® Angled Occlusal Stainless Steel Photographic Mirrors is double-ended to accommodate both small and large patients. The mirror is angled approximately 15° to allow patient or operator to hold and keep hand out of camera view. Polished on both sides.

Ea. **SSMROCANG**

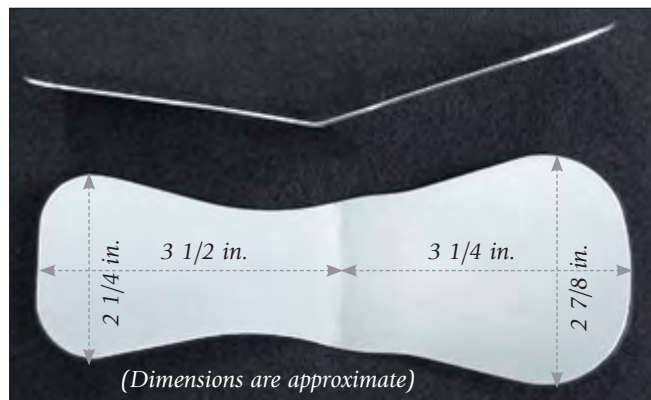

Photographic Mirrors - Stainless Steel

G&H® Stainless Steel Photographic Mirrors offer the ultimate in durability. Highly polished stainless steel surfaces cannot chip, crack or peel. Double-sided for maximum life, the mirrors have polished, rounded edges for patient comfort and are compatible with autoclave sterilization. Note: sizes and shapes vary slightly from illustrations.

- | | |
|----------------------|----------------|
| Ea. | |
| Occlusal | SSMROC |
| Buccal | SSMRBC |
| Lingual | SSMRLG |
| Set of (3) | SSMRKT3 |
| Includes (1) of each | |



Cleaning and Sterilization Recommendations for Photographic Mirrors

- Gently wash mirrors with mild hand soap using alcohol to remove greasy substances such as lipstick.
- Dry the mirror with a soft cloth lightly then air dry until all moisture has evaporated.
- Any spots left on mirror will not come off after heat or autoclave sterilization. If the mirror can not be cleaned right away keep it wet or covered with a wet towel.
- Never place a mirror into an ultrasonic unit.
- Keep the mirror out of contact with all other instruments. Wrap the mirror into a microfiber cloth or paper towel and place it in the sterilizing pouch. The wrapping will absorb any steam that builds up on the mirror inside the pouch.
- Follow the sterilization recommendations as provided by the manufacturer of your sterilizer.

Universal Photographic Mirror Handle

SureGrip™ universal photographic mirror handle is clinically functional and user friendly. Makes taking unobstructed intraoral photographs easy from any angle.



Fully adjustable - mirror can be positioned and held at any angle.

Handle length: 4.5"

Suregrip™ for Premium Glass Mirrors **SGPR**
 Suregrip™ for Stainless Steel Mirrors **SGSS**

Components

Premium glass mirror head unit **SGPRH**
 Stainless steel mirror head unit **SGSSH**
 Handle only - (Fits either head) **SGH**



Cold sterilization and dry heat sterilization not recommended

Moyco® Indian Head Mouth Mirrors

Electro-polished, rhodium-coated.
 12/box

- | | |
|----------------|------------------|
| #3 Simple stem | 011-24677 |
| #4 Simple stem | 011-24678 |
| #5 Simple stem | 011-24679 |
| #6 Simple stem | 011-24680 |
| #3 Cone socket | 011-24692 |
| #4 Cone socket | 011-24693 |
| #5 Cone socket | 011-24694 |
| #6 Cone socket | 011-24695 |

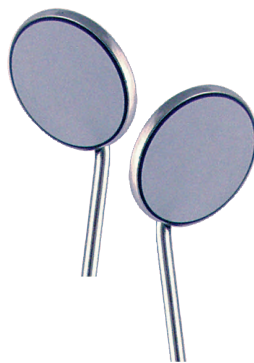

Mirror Handle

Ea.

- | | |
|---------------------------------|---------------|
| 5" Handle - Simple Stem. | |
| Octagonal | 07-400 |
| Round | 07-410 |
| 5" Handle - Cone Socket | |
| Octagonal | 07-405 |
| Round | 07-420 |



Disposable Mouth Mirror

100/pkg.

MMR-1



Disposable Mouth Mirror

48/pkg.

200MMR-A

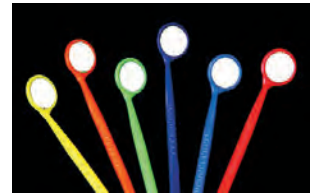

Bausch Articulating Paper

200 microns, 300 strips in a plastic dispenser.

Ea.

BK-01



Bausch Occlusionspapier

Micro-thin 40 microns, 200 strips.

Ea.

BK-09



AccuFilm I Occlusal Marking Film

280 strips.
 Single sided, red

S015



AccuFilm II Occlusal Marking Film

Eliminates false occlusal markings.
 Use dull side for marking. 280 strips.

- | | |
|---------------------------|-------------|
| Double sided, red/black | S017 |
| Double sided, black/black | S018 |
| Double sided, red/red | S021 |



Crosstex® Occlusal Marking Film

144 strips.

- | | |
|------------------------|-------------|
| X-thin, blue | TPXT |
| Thick, blue | TPTH |
| Thin, blue | TPT |
| Double sided, red/blue | TPBR |



Archwire Marking Pencils

Made with high quality beeswax tip on disposable stick which ensures mark will stay in place. It is not water soluble like crayon-based markers.

100/pkg.

Red-tip Pencils
White-tip Pencils

AMP020
AMP020W



Pop-Up Dispenser

Push-button action dispenses one pencil on demand.

Ea.

AMD010

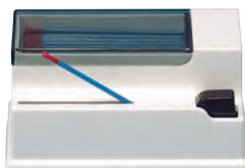

(Actual product style may vary from image)

Topical Anesthetic

Contains 20% Benzocaine for maximum pain relief. Bubble gum flavored.

1 oz.

11-31005



Topical Anesthetic Spray

20% Benzocaine, delivers fast maximum strength pain relief, ideal for deep scaling and gag relief. Wild cherry flavored - 25 straws.

2 oz.

AD31000



Defend® Plastic Cups

5 oz. - 1,000/box

White
Blue
Maue
Green
Lavender

DC-7000
DC-7001
DC-7002
DC-7003
DC-7004



Tidi® Plastic Cups

5 oz. - 1,000/box

Lavender
White
Green
Blue
Yellow
Gray
Maue
Peach

9210
9211
9212
9213
9214
9215
9216
9218



3.5 oz. - 1,000/box

White
Blue

9241
9243

Cup Holder

Ea.

1202P



Crosstex® Cup Holder

Ea.

PCC



Tidi® Disposable Headrest Covers

500/box

10"x13"

919512



Tidi® Disposable Headrest Covers

500/box

10"x10" - White
10"x10" - Clear
13"x10" - White
13"x10" - Clear
13"x13" - White

919611
919612
919621
919622
919631



Headrest Covers

250/box

9 1/2"x11"
10"x14"

PS650
PS660

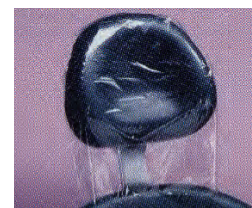



ORTHOCLUB[®]
WHOLESALE BUYING GROUP



EXCLUSIVE MEMBER BENEFITS

- ▶ The power of wholesale buying volume discounts on our entire line - over 6,000 items
- ▶ Special member-only promotional savings
- ▶ The quantities you need when you need them—no need to carry excessive inventory
- ▶ No minimum purchase required
- ▶ \$400 annual membership, is more than covered in annual savings. Like everything at G&H, your satisfaction is guaranteed!*
- ▶ **Exclusive offers**
- ▶ **New member Bonus Pack - \$200 of FREE product samples**

**SIGN UP
TODAY!**

Join today at:

GHOrthoClub.com
or call: **800-526-1026**
and **START SAVING!**

The Club that pays you back in savings!

GHOrthodontics.com • Toll-Free 800-526-1026 • **orders@ghortho.com**

*Membership fee credited if not fully satisfied within the first 6 months.

Chair Covers

225 sleeves per roll - 27.5" x 24"
 Ea. **915001**

Full chair cover - 200/box
 Ea. **PS105**



Tray Sleeves

500/pkg.
 10 1/2" x 14" **PS201**
 11 1/2" x 16" **PS203**
 7 1/2" x 10 1/2" **PS204**



Tidi® Tray Covers

8 1/2" x 12 1/4" - 1,000/pkg.
 White **917511**
 Green **917512**
 Blue **917513**
 Yellow **917514**
 Mauve **917516**
 Lavender **917519**

9 1/2" x 12 3/8" - 1,000/pkg.
 White **917521**
 Blue **917523**

9 1/2" x 13 1/2" - 1,000/pkg.
 White **917531**

10 1/4" x 17 3/4" - 1,000/pkg.
 White **917541**

11" x 17 1/4" - 1,000/pkg.
 White **917551**

11" x 17 1/4" - 1,000/pkg.
 Blue **917553**

5" x 8" - 1,000/pkg.
 White **917571**



Defend® Tray Covers

8 1/2" x 12 1/4" - 1,000/pkg.
 White **TC-9000**
 Blue **TC-9001**
 Mauve **TC-9002**
 Green **TC-9003**
 Lavender **TC-9004**



Flat Tray

Size (A) 10 1/2" x 10 1/2"
 Ea. White **300AF-1**

Size (B) 13 1/2" x 9 3/4"
 Ea. White **300BF-1**
 Teal **300BF-14**
 Light Blue **300BF-2**
 Green **300BF-4**
 Flame **300BF-5**
 Coral **300BF-6**
 Beige **300BF-7**
 Light Gray **300BF-9**
 Neon Purple **300BFS-10N**
 Light Mauve **300BFS-10PL**
 Lilac **300BFS-10PS**
 Tangerine **300BFS-12**
 Neon Blue **300BFS-2N**
 Baby Blue **300BFS-2PS**
 Neon Yellow **300BFS-3N**
 Neon Green **300BFS-4N**
 Neon Pink **300BFS-6N**



Size (E) 15" x 10 1/2"
 Ea. Light Blue **300EF-2**

Size (F) 9 3/4" x 6 1/2" (Mini)
 Ea. White **300FM-1**
 Baby Blue **300FMS-2PS**
 Neon Green **300FMS-4N**
 Neon Pink **300FMS-6N**
 Sand **300FMS-7PS**

Tub and Tray Colors

STANDARD	
Flame	
Coral	
Beige	
Lt. Gray	
Green	
Lt. Yellow	
Lt. Blue	
White	
Teal	
PASTELS	
Lt. Mauve	
Sand	
Baby Blue	
Lilac	
Sea Green	
Vanilla	
Tangerine	
NEONS	
Neon Green	
Neon Purple	
Neon Pink	
Neon Blue	
Neon Yellow	

Tray Lids

Size (B)
 Ea. **300BB-COVR**

Size (F)
 Ea. **300FM-COVR**



Chrome Tray Racks

Ea.

Size (B) - Holds 8 Trays
 14 1/2"W x 9 3/4"D x 14 1/8"H **300TRB-C**

Size (D) - Holds 8 Trays
 14 1/2"W x 9 3/4"D x 14 1/8"H **300TRD**

Size (F) - Holds 6 Trays
 10"W x 6 1/4"D x 13"H **300TRF**



Tidi®
Poly Towel 2-Ply

Poly-backed for dependable patient protection, diamond-embossed for a thicker, absorbent feel. 13"x18".

500/pkg.

Lavender	919459
White	919461
Green	919462
Blue	919463
Yellow	919464
Gray	919465
Mauve	919466
Beige	919467
Peach	919468
Teal	919470



Patient Bibs 2-Ply

Horizontal embossing allows the moisture to flow horizontally across the towel, protecting the patient's clothing. 13"x18".

500/pkg.

Blue	BIB-2
Green	BIB-4
Lavender	BIB-10L
White	BIB-1
Yellow	BIB-3
Pink	BIB-6
Peach	BIB-12P



Bib Holders

Front Load.

Ea. **1205B**

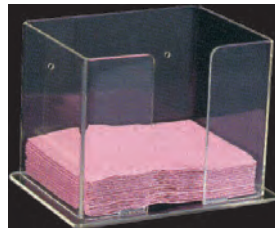

Ear-Loop Mask Holder

Ear-loop face mask organizer. 8 1/2" x 5 1/4" x 5".

Ea. **1212**

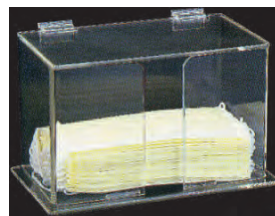

Harmony®
Ear-Loop Face Mask

Latex-free. Blue. 10 boxes/case

50/Box **FEL220B**



Adenna®
Ear-Loop Face Mask

Fiberglass-free & latex-free. 10 boxes/case
50/box

Blue
Pink
Violet
White

FEL110B
FEL110P
FEL110V
FEL110W



Crosstex®
Ear-Loop Face Mask

Fiberglass-free & latex-free.
Blue. 10 boxes/case

50/box

GCABL



Crosstex® Isofluid®
Ear-Loop Face Mask

Fiberglass-free & latex-free.
Lavender. 10 boxes/case

50/box

GCILV



Defend®
Molded Cone Face Mask

Blue, 50/box

Pink , 100/box, 10% smaller than blue

MK-1007
MK-1001



Beesure
Face Mask

- 100% latex-free and fiberglass-free filter layers.
- Dye-free, chemical-free and soft comfort cellulose inner layer
- Breathe smoothly without moisture buildup
- >98% particle filtration provide secure protection.
- Quad-fold (4-fold) design easily forms a cone-like shape to provide exact fit.

Product Specification

PERFORMANCE

Particle Filtration Efficiency (PFE): > 98%

Differential Pressure, ?P (Breathability): < 2.0 mm

MASKS FEATURES

Description: 3-ply, 4-fold ear-loop face mask

Length: 178 mm±2mm

Height: 90 mm±2mm

50/box

954-9852



Ultra 3-in-1 Fog Free Ear-Loop Face Mask

Inner and outer fog-free strips eliminate fogging up of eyeglasses. Along with being ultra breathable, they have ultra high filtration.

50/box
 Blue **950-8040**
 Multi-Colored **950-8042**
 Peach **950-8044**



Adenna® Gold Powder-Free Latex Gloves

100/box (90/box for XL), 10 boxes/case
 Ea./box
 X-Small **GLD260**
 Small **GLD262**
 Medium **GLD265**
 Large **GLD266**
 X-Large **GLD268**



Adenna® Bronze Powder-Free Latex Gloves

100/box (90/box for XL), 10 boxes/case
 Ea./box
 X-Small **BRZ640**
 Small **BRZ642**
 Medium **BRZ645**
 Large **BRZ646**
 X-Large **BRZ648**



Note: Adenna Bronze Latex Gloves are not available for Canadian shipment.

Adenna® Miracle® Powder-Free Nitrile Gloves - Latex-Free

200/Box (180/box for XL),
 10 boxes/case
 Ea./box
 X-Small **MIR160**
 Small **MIR162**
 Medium **MIR165**
 Large **MIR166**
 X-Large **MIR168**



Adenna® Powder-Free Nitrile Gloves - Latex-Free

100/box (90/box for XL), 10 boxes/case
 Ea./box
 X-Small **NPF880**
 Small **NPF882**
 Medium **NPF885**
 Large **NPF886**
 X-Large **NPF888**



Adenna® Precision® Powder-Free Nitrile Gloves - Latex-Free

100/box (90/box for XL), 10 boxes/case
 Ea./box
 X-Small **PCS770**
 Small **PCS772**
 Medium **PCS775**
 Large **PCS776**
 X-Large **PCS778**



Adenna® Night Angel® Powder-Free Black Nitrile Gloves - Latex-Free

100/box (90/box for XL), 10 boxes/case
 Ea./box
 X-Small **NGL220**
 Small **NGL222**
 Medium **NGL225**



Adenna® Powder-Free Vinyl Gloves - Latex-Free

100/box (90/box for XL), 10 boxes/case
 Ea./box
 Small **VPF232**
 Medium **VPF235**



Glove Rack

Fits one standard size glove box horizontally or two boxes vertically. Mounts easily onto wall with included hardware.

Ea. **BHW501**



Acrylic Glove Dispenser

#1400H: Fits one standard size glove box horizontally. Mounts easily onto wall. Dimensions are 10" W x 5 3/4" H x 3 1/8" D.
 #1400: Fits one standard size glove box vertically. Mounts easily onto wall. Dimensions are 5 3/4" W x 10" H x 3 1/8" D.

Horizontal Ea. **1400H**



Kodak® Manual Processing

GBX

Twin Pack
28 oz. Dev. & Fixer **190-1859**
Fixer
28 oz. **190-1875**
Developer
28 oz. **190-0943**



Kodak® Automatic Processing

Readymatic Chem Pack

2 gal. Developer, 2 gal. Fixer
Ea. **102-8869**



Kodak® Automatic Processing

Readymatic Fixer

5 liter (1.3 gal.)
Ea. **5285937**



Kodak® Automatic Processing

Readymatic Developer

5 liter (1.3 gal.)
Ea. **877-7534-1**



Dent-X

Chem Pak

2 gal. Dev., 2 gal. Fixer **952-2958**



Clear Image®

Processor Cleaner

Qt. - w/pump **CI-32-12**



Sharp Image®

**Roller Transport
Clean Up Sheets**

Daily cleaning sheets.
50/pkg. **CI0810**



X-Ray Apron

Child Dual Apron
Ea. Blue **26CBLUE**

Apron Hanger

Chrome plated, 3/16" steel hanger recommended to protect garments and increase product life. Will hold up to 50 lbs. (22.7 kg) and will not stress the lead vinyl or outer covering.
Ea. **33**

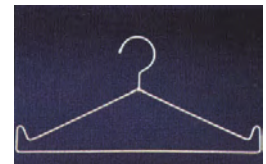

Ordering online is quick and easy!



- How do I get started?
 - 1) Activate your account for online access - GHOrthodontics.com/activate
 - 2) Set your password
- Quick Reorder – Reorder products with just a few clicks – View 2-year order history
- Add product samples quickly to your order
- Updated product sections for easier ordering
- View latest product videos, brochures and catalogs



Kodak® Ceph Film

50/box
XDBF-1, 8x10 **802-1933**
TMG-1, 8x10 **845-3938**

Kodak® Ultra Speed Periapical Film

DF-56 #1 - 100/box **127-3747**

Kodak® Pan Film

50/box
EVG-15, 6x12 **837-2716**

Kodak® Duplicating Film

50/box
5x12 **121-5821**
15x30 **149-3691**



Fuji® Pan Film

100/Box
Super HR-U, medium speed, green,
high contrast orthochromatic film for
use with green emitting rare earth
screens
Super HR-U, med. speed,
Green, 15x30 **HRU5050**
Super HR-U, med. speed,
Green, 5x12 **HRU5052**

Super RX Blue, high speed, high
contrast, blue sensitive film for use
with blue emitting screens
Super RX, Blue, 15x30 **PPB5050**
Super RX, Blue, 5x12 **PPB5052**

Super HR-T, medium speed, green,
high resolution, high contrast,
orthochromatic film for use with green
emitting rare earth screens

Fuji® Ceph Film

100/box
Super HR-U, Med. Speed,
Green, 8x10 **HRU5080**
RX Blue, 8x10 **PPB5080**



Full Line Quality Orthodontic Products

Orthodontists have one of the most important jobs – bringing renewed self-confidence and pride to every patient through improved smiles.

Order our full line of products at: GHOrthodontics.com

Hygienic
Bite Wafers

Without Foil - 50/pkg. **H00839**
With Foil - 24/pkg. **H00825**



Utility Wax Strips

75/box **UWX1164**
450/box **700-117**



Miltex®
Beauty Wax

Pink - 1 lb. **116-56450**
Soft **116-56510**
Medium **116-56630**
X-Hard

Pink - 5 lb. **117-56470**
Soft **117-56530**
Medium **117-56650**
X-Hard

White - 1 lb. **120-57130**
Soft



Miltex®
10x Pink Wax

1 lb. **195-55500**



Miltex®
Sticky Wax

24/box
Red **180-58351**
Brown **180-58291**



Modern Materials®
Bite Wax Sheets

Yellow
1 lb. **50093614**
5 lb. **50093654**



Modern Materials®
Utility Wax Strips

Large - 75 strips **50094191**



Modern Materials®
Copwax

84/box **50092178**



Modern Materials®
Check Bite

Yellow wafers
120/pkg. **50095194**



Low/Medium Heat
Compound Sticks

15/pkg.
Red/low heat **6060300**
Green/low heat **6060500**



Pozzi®/Leone®
Ortho Resin Acrylic

Ortho Resin Acrylic Kit
Kit includes 16 oz. Powder & 8 oz. Liquid

Clear kit **19822/C**

Ortho Resin Liquid (Monomer)
8 oz. Clear **20024/C**
8 oz. Pink **20024/P**

Ortho Resin Powder (Polymer)
16 oz. **20032**



Trim-Rite®
Releasing Agent

Helps prevent vacuum formed plastic from sticking to models.
12 oz. **21004**



4" Diameter
Rag Wheel

Ea. **1180160**



3" Diameter
Heatless Stone

Ea. **1900080**



ProForm®

Retainer Material

5"x5" - .030 Super clear

25/pkg. **9615025**
50/pkg. **9614816**



ProForm®

Mouthguard Resin Material

.160 - 25/pkg. | .200 - 12/pkg.

Clear	9597940	9601215
Blue	9597680	
Black	9597660	
Orange	9597720	
Purple	9597725	
White	9597750	



Essix®

Plastics

100 Sheets/pkg.

A+ 5" Square/Vac. .030"	10035
A+ 5" Square/Vac. .040"	10045
A+ 5" Square/Vac. .060"	10065
A+ 5" Square/Vac. .080"	10085
A+ 125mm Square/Bio. .040"	10040
A+ 125mm Round/Bio. .030"	11030
A+ 125mm Round/Bio. .040"	11040
A+ 125mm Round/Bio. .060"	11060
A+ 125mm Round/Bio. .080"	11080
Ace 5" Square/Vac. .030"	1A350
Ace 5" Round/Bio. .030"	1A325
Ace 5" Square/Vac. .035"	1AH50
Ace 5" Round/Bio. .035"	1AH25
Ace 5" Square/Vac. .040"	1A450
Ace 5" Square/Bio. .040"	1A478
Ace 5" Round/Bio. .040"	1A425
C+ 5" Square/Vac. .040"	1C500
C+ 125mm Square/Bio. .040"	1C478
C+ 5" Round/Bio. .040"	1C125



Therma Frost™ Refrigerant Spray

Chairside use for chilling Thermal Activated NiTi. For use outside the oral cavity only. (Cannot be shipped internationally)

10 oz. **TFROST**



Headband Style

Magnifier

One-touch design - switch between 1.8X, 2.3X, 3.7X & 4.8X

Ea. **1150120**



Compact

Micro Torch

Lightweight and compact, this torch is equipped with an instant electronic ignition system for reliable starting. Includes a removable base for free-standing or handheld use.

Ea. **MT-9000**



Leone®

Silver Solder Wire Form

Cadmium free. Silver content: 55%. Wire form, 0.40 mm in diameter. 10g approx.

Ea. **R0222-00**



Leone®

Silver Solder Tape Form

Cadmium free. Silver content: 55%. Tape form, 1 x 0.5 mm. 10g approx.

Ea. **R0223-00**



Leone®

Silver Solder Straights

Cadmium free. Silver content: 55%. Rods, 1 mm in diameter. 10g approx.

Ea. **R0224-00**



Solder

0.031" 1/4 troy ounce, 6 ft.

Ea. **SLVSLD**



Leone®

Fluoride Flux Paste

1 oz. **R0226-00**



Flux

1/4 lb. **75012**



Ball Clasps

1 1/2 inch overall length - 100/pkg

.024	SSBC024
.028	SSBC028
.032	SSBC032
.036	SSBC036
.040	SSBC040



Towelettes

Caviwipes®

CaviWipes are durable, nonwoven, nonabrasive towelettes that offer quick, easy-to-use, time-saving convenience. 12 canisters/case.

6"x6" - 160 wipes/canister **13-1100**
 9"x12" - 65 wipes/canister **13-1150**



Towelettes

Discide® Ultra

12 Canisters/Case.
 6"x6" - 160 wipes/canister **60DIS**



Towelettes

Sani-Cloth® Plus Germicidal

12 Canisters/Case.
 6"x6" - 160 wipes/canister **SANLS**



Towelettes

Sanitex Plus®

12 Canisters/Case.
 6"x6" - 160 wipes/canister **SANLC**



Disinfecting Spray

Lysol® I.C.

19 oz.
95029



Ultradose

General Purpose Cleaner

This powder cleans instruments, burs, general equipment, orthodontic appliances, gold and porcelain. One packet makes one gallon of cleaning solution.

24/box **UD030**



Tartar & Stain Remover

Use this potent stain remover on dentures, bridges, crowns and orthodontic appliances. The ready to use formula quickly breaks up and removes calculus and tartar while eliminating stains caused by tobacco and food. Use in a beaker placed inside the ultrasonic unit for best results. 1 gallon (3.8L)

1 Gal. **SO-9600**



Prosonic

General Purpose

Gal.
21351



Opti-Cide 3® Disinfectant

4 gallons/case.
 Gal. **OCP04-128**
 24 oz. w/pump **OCS12-024**



Metrex®

Cavicide® Disinfectant

4 gallons/case
 Gal. **13-1000**
 24 oz. w/Pump **13-1024**



Discide® Ultra Disinfectant

4 gallons/case.
 Gal. **3565G**
 Qt. **3565Q**



Concentrated

E-Vac Evacuation System Cleaner

Specially formulated to dissolve organic debris, rope saliva and blood. Powerful non-foaming solution cleans away calcium buildup in the lines. Gallon makes 128 treatments.

Gal. **00107**



Super-Concentrated

PureVac® Evacuation Cleaner

Dissolves away the toughest debris to provide optimal suction.

2 Liter **21113**
5 Liter **21115**



EZ Scoop Aquazyme

Enzymatic Cleaner

For removal of Proteinaceous soils, blood, tissue and mucus. (1) 750g Jar. Makes up to 75 gallons of solution.

750g **DP2200**



EZ Scoop

Evac System Cleaner

Cleans and Deodorizes. Safe, Non-Corrosive and Biodegradable. (1) 750g Jar produces 75 evacuation cleanings.

750g **DP3300**



Defend®

SRG® Evacuation System Cleaner

Gallon makes 128 treatments.

Gal. **SO-9100**



3% Glutaraldehyde

MicroCide 28® Sterilant

Provides an efficient and safe means for high-level disinfection or sterilization. 4 gallons/case.

Gal. **MC28-04-128**



2.5% Glutaraldehyde

Metricide 28™ Sterilant

Reusable, high-level disinfectant for up to 28 days. 4 gallons/case.

Gal. **10-2800**



2.5% Glutaraldehyde

ProCide-D™ Sterilant

Reusable, high-level disinfectant on immersible lensed and delicate instruments for up to 28 days. 4 gallons/case.

Gal. **10-2860**



Non-Glutaraldehyde

Sporox II® Sterilant

Powerful hydrogen-peroxide based sterilant and high-level disinfectant for heat-sensitive instruments. 4 gallons/case.

Gal. **75156**



Non-Glutaraldehyde

Compliance™ Sterilant

Does not require activation or test strip and can be used at room temperature. 4 gallons/case.

Gal. **10-2500**



Defend

General Purpose Cleaner

Non-ammoniated rust inhibitor. 4 gallons/case.

Gal. **SO-9400**



UltraDose®

Ultrasonic Cleaning Solution

An excellent cleaner of instruments, burs and orthodontic appliances. Each 1 ounce packet makes one gallon of cleaning solution.

24/box **012**



Ortho-Clean®
Ultrasonic Cleaner

Gal. **OC401**



UltraDose®
Germicidal Ultrasonic Cleaner

Cleans and disinfects inanimate, non-porous instrument and appliance surfaces.

16 oz. **UD036**



Dentronix®
MP-US Plus

Does not require distilled water. No-rinse formulation saves time and is odorless.

(4) - 8 oz. **DMP-USP**



Enzymatic Cleaner
VibraKleen Tablets

20/pkg. **50037100**



Crosstex®
Efferzyme Tablets

Made from a biodegradable, non-chlorine formulation that contains fast acting protease enzymes. Place 2 tablets in gallon of warm water.

52/box **JET**



EZ Scoop
Alginate Remover

Ultra-high performance alginate remover and tray cleaner. Non-corrosive, non-toxic and biodegradable.

840g **DP2900**



EZ Scoop
Plaster/Stone Remover

840g **DP2400**



EZ Scoop
Autoclave Cleaner

Ultra-high performance autoclave chamber cleaner. Safely cleans and is non-corrosive and biodegradable.

750g **DP3000**



Speed Clean® Autoclave Cleaner

16 oz. bottle **953-5770**



Birex® SE One-Step Germicidal Detergent

(4) 1/8 fl. oz. pkts. **954-0594**



BluTab™
Waterline Maintenance Tablets

50/pkg. **953-4056**



PeelPro™ Self-Sealing
Sterilization Pouch

Dual internal and external steam and gas sterilization indicators. Autoclavable or chemclavable.

200/pkg.
2 3/4"x10" **88000**
3 1/2"x10" **88010**
5 1/4"x11" **88015**



Self-Sealing
Sterilization Pouch

For steam or dry heat - color indicator.

100/pkg.
2"x9 1/2" **10032**
3"x10" **10033**
4"x10" **10034**



Adenna® Self-Sealing
Sterilization Pouch

200/pkg.
2 1/4"x4" **SPH2350**
2 3/4"x10" **SPH2810**
3 1/2"x10" **SPH3510**
3 1/2"x6 1/2" **SPH3565**
5 1/4"x11" **SPH5311**



Sure-Check®

Sterilization Pouch

Gives you the assurance of confirming all 3 sterilization parameters: time, temperature and presence of steam.

200/pkg.

5 1/4"x10"
3 1/2"x9"
3 1/2"x5 1/4"
2.25"x4"

SCM2
SCS2
SCXS2
SCXX2



Sure-Check®

Sterilization Strips

Indicates all conditions for sterilization have been achieved - time, temperature, and presence of steam.

100/box

SCK



EMS Sterilizer Monitoring Service

The EMS is certified for use in steam, dry heat, and EO gas processes.

12/pkg.
52/pkg.

EMS-012
EMS-052



Nyclave®

Dry Heat Indicator Labels

Pressure sensitive - changes color with dry heat sterilizer temperatures.

125/box

862-1747



Cellulose

Indicator Tape

Indicates specific temperature has been achieved during sterilization cycle.

3/4" - 60 yd./roll
1/2" - 60 yd./roll

STM
STS



Highly Permeable

CSR Wrap

Use with ETO, steam, gamma irradiation or E-beam sterilization technology.

100/pkg.

12"x12"
15"x15"
18"x18"
20"x20"

SW12
SW15
SW18
SW20



Crosstex®

Sani-Tube®

Use in steam, chemical vapor or dry heat (up to 425°F/218°C).

2"x100'/roll
3"x100'/roll
4"x100'/roll
6"x100'/roll

S12
S13
S14
S16



Richmond/Tidi

Cotton Rolls

Braided - Rolls are braided with silky yarn. Non-sterile.

3/8"x1 1/2" Med. - 2,000/box
4" Medium - 200/box
6" Medium - 200/box

200204
201226
201208

Wrapped - 100% cotton interior. Wrapped in non-woven fabric and starch-free. Non-sterile.

3/8"x1 1/2" Med. - 2,000/box
5/16"x1 1/2" - 2,000/box
3/8"x6" - 500/box

200404
969120
969122

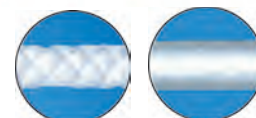

Braided

Wrapped

Crosstex®

Cotton Rolls

Non-sterile, made from 100% cotton.

1 1/2"x3/8" - 2,000/box

DNAC



White

Cotton Roll Holder

Holds one pkg. of cotton rolls.

Ea.

1426



Cotton Roll Dispenser

Hinged lid for easy loading. Holds one pkg. of rolls.

Ea.

207CRD-1



Crosstex®

Cotton Tip Applicators

1,000/box

3"
6"

CS-3000
CS-6000



Spring Action
Sponge Dispenser

Spring action releases pads one at a time.

Ea. **4002SD-1**



Woven
Gauze Sponges

Cotton-filled, non-sterile gauze sponges feature a woven gauze facing with an absorbent cotton fill.

2"x2" - 5,000/box **919000**
4"x4" - 2,000/box **908224**



Non-Woven
Gauze Sponges

4-ply, poly/rayon closed weave, non-sterile, nonwoven sponges. Will not catch on brackets.

2"x2" - 5,000/box **2020-NW**
4"x4" - 2,000/box **4040-NW**



Cotton-Filled
Gauze Sponges

8-ply sponges are shred-resistant and are made of 100% cotton filled.

2"x2" - 5,000/box **CS-0100**



Defend®
Tongue Depressors

100% wood, smooth and splinter-free. 6" in length and non-sterile.

500/box **TD-9000**



Vionex®
Skin Lotion

Lotion does not contain mineral oil or petrolatum, which breaks down latex. It is not greasy and does not interfere with gloving. Contains Aloe Vera.

8 oz. **10-1318**



Vionexus®
No-Rinse Spray

1 Liter **10-1800**



Vionex®
Hand Wash Gel

No-rinse gel antiseptic handwash.

18 oz. **10-1628**



Vionex®
Hand Soap

Gal. **10-1500**



Micrell™
Antibacterial

Hand Soap

8 oz. **9752**
Gal. **9755**



Moist Sure™
Antibacterial

Hand Soap

Gal. **95728**



Sanityze™
Waterless Gel

18 oz. **JWGP**



Vionex®
**No-Rinse Spray
No-Touch Dispenser**

Eliminates cross-contamination.

Ea. **10-1810**



70% Isopropyl
Alcohol

32 oz. bottle **00097**
Dispenser **48**



Hygienic

Single-Fold - Natural Paper Towels

Made with 100% recycled fiber.
(23.50 cm x 26.04 cm)
16 packs of 250 towels, 4,000 total towels.

Ea. **SPC01800**



Multi-Fold - Natural Paper Towels

Made with 100% recycled fiber.
(22.86 cm x 24.13 cm)
16 packs of 250 towels, 4,000 total towels.

Ea. **SPC01920**



Multi-Fold - White Paper Towels

Made with 100% recycled fiber and over 88% post-consumer content.
9.5" x 9.12" - 16 packs of 250 towels, 4,000 total towels.

Ea. **GJO21100**



C-Fold - White Paper Towels

Made with 100% recycled material.
10" x 13" (25.4 cm x 33.02 cm)
10 packs of 240 towels, 2,400 total towels.

Ea. **SPC01095**



C-Fold Towel Holder

Provides easy access to C-Fold absorbent towels.

Ea. **1206**



Deluxe Safety Glasses

The fully adjustable temples and lightweight nylon frame allow for optimal comfort and fit. The molded-in nose bridge comfortably fits a wide variety of faces.

Clear/Black frame **99910**
Clear/Blue frame **99920**



Economy Safety Glasses

One-piece construction with defined side shields and brow guard for more protection.

Clear **CB9255**



Sleek Safety Glasses

Clear **CB9259**
Gray **CB9261**



UV Glasses

Ea. **3600**



UV Protective Safety Glasses

Uvex Skyper and Uvex Skyper Spec 2000 protective eyewear for use without prescription glasses. These glasses absorb 99.9% of harmful UVA and UVB radiation.

Uvex Skyper **SG**



Bite Block Cover

Clear, convenient plastic barriers for use with Pano-X-Ray machine bite blocks. Economical way to reduce cross-contamination, eliminating the need for disinfection or sterilization. 1" x 2"

1000/pkg. **1850**



Siemens Bite Block Cover

Clear, convenient plastic barriers for use with Siemens X-Ray machine bite blocks. Economical way to reduce cross-contamination, eliminating the need for disinfection or sterilization. 1 1/2" x 3"

500/pkg. **1850S**



Clean Cover T-Light Handle Protector

Reduce the risk of cross-contamination when touching the light repeatedly. 5 3/4" x 4 1/4"

500/box **1914**



Air/Water Syringe Tip Cover

Designed to be used with virtually all air/water syringes. Easily slides over the existing syringe tip. The hub design provides for easy, one-handed tip rotation. Dispose of after each patient.

100/pkg. **1950**



Air/Water Syringe Tip Cover

Offers convenient protection against cross contamination. 2 1/2" x 10".

500/pkg.
Closed End **915002**
Open End **915006**



Surface Barrier Film

Surface barriers reduce the risk of cross contamination caused by airborne aerosols, splash and spatter. 4"x6" (10x15cm).

1,200 ft.

Blue
Clear
Purple

PS1250B
PS1250C
PS1250P

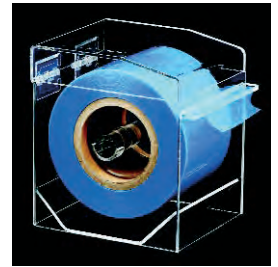

Latex Multi-Use Barriers

For use with pens, pencils, scalars, mirror handles, bite blocks, toggle switches and much more.

500/pkg. **088-058**



Biohazard Sharps Containers

1 Qt.
4 Qt.
8 Qt.

SC-01QT
SC-04QT
SC-08QT



Looking for
clinical
supplies?

You'll find what you need in our
full line of quality products!

From lab supplies to clinical treatment products,
G&H offers more than 6,000 brand-name items and precision
G&H manufactured products.

Order online at: GHOrthodontics.com

MicroCab Filter

Fits MicroCab, MicroCab Plus+, and MicroCab+. (New).

Ea. **49055**



MicroCab Window

For MicroCab only.
(MicroCab+ and MicroCab Plus+ window parts listed below).

Ea. **49105**

Protective Shield, 10/pkg. **201359**
5x5x7"



Replacement Windows

MicroCab Plus+, 10/pkg. **91286**

MicroCab+ (New), 10/pkg. **93817**



Microcab Hand Guards

MicroCab, 2/pkg. **59024**

MicroCab Plus+ AND
MicroCab+ (New), 2/pkg. **91518**



Danville Engineering® MacroCab Plus

Compact, yet larger than MicroCab, unit offering an efficient and comfortable design where you only insert your fingers with handpiece to work. Bright, fluorescent light provides ideal illumination. Featuring built-in dust collection/filtration system. Dimensions: 7" H x 10" W x 14" D.

- Large, compact and versatile for easy use
- Super quiet suction system
- Built-in bright, fluorescent lighting
- Swing open access to easily clean filter
- 110v

Ea. **91556**

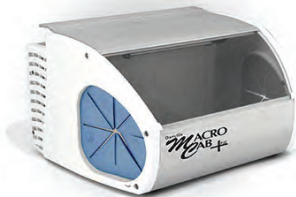

Please note individual component parts exist for MacroCab Plus (New), and MacroCab units. Please verify which unit you are ordering components for. Appropriate components for each unit are available as listed.

MacroCab Filter

MacroCab, Ea. **116545**

MacroCab Plus, Ea. **91557**



MacroCab Window

For MacroCab only.

Ea. **185508**

Protective Shield, 10/pkg. **201360**



Replacement Windows

For MacroCab Plus only.

10/pkg. **93960**



MacroCab Hand Guards

MacroCab, 2/pkg. **59026**

MacroCab Plus, 2/pkg. **91518**



MacroCab Hand Guard



MacroCab Plus Hand Guard

Aluminum Oxide

1 lb.

90 Mic. - Tan **15201**

50 Mic. - White **15301**



Danville Engineering® MicroEtcher II-A

The MicroEtcher IIA is recognized as one of the most valuable tools for orthodontists. The MicroEtcher provides precise surface micro-roughening, improving bond strength up to 400%. Surface area and surface reactivity is dramatically increased for maximum bond. Sandblasting is fast and easy with most surface roughening procedures requiring only a few seconds.

- Totally autoclavable
- Fast & easy cement removal
- Finger button control

Ea. **22005-01**



Danville Engineering® MicroEtcher II

All the performance and applications offered by the model IIA. Only the nozzle is autoclavable. All stainless construction. Replaceable carbide tip.

- Nozzle can be rotated 360° and removable for autoclaving
- Fast & easy cement removal
- Finger button control

Ea. **22000-03**



Danville Engineering®
MicroEtcher ERC

The economical MicroEtcher ERC model offers the same performance and durability as the MicroEtcher II and IIA. The nozzle rotates 360° but is not removable. ERC can be cold sterilized but not autoclaved. It is not intended for intraoral use, and features stainless construction.

- Finger button control
- Clean & prepare orthodontic brackets
- Nozzle can be swivelled 90° to either side

Ea. **21000-03**



Replacement Oxide Jars

Ea.
Microetcher II/II-A **201502-00**
Microetcher ERC **25026**



Quick Disconnect Kit

Quick disconnect kits allow easy connection to house air. Full pressure air line is cut and slid onto barbed tee.

Ea.
Lab **44007**



Quick Disconnect Male Assembly

Ea. **44020**



Microetcher II Nozzle

Interchangeable nozzles for the MicroEtcher II and II-A. New smaller .032" tip is ideal for intraoral applications as it reduces the amount of dust and provides for a more focused pattern of abrasive.

Ea.
.048" Reg. **201802-00**
.032" Slim **201865-00**



Sand Traps for Microetcher

Soft plastic spheres slip onto high speed suction, and with the MicroEtcher tip inserted through the top opening, traps the abrasive.

15/pkg. **22006**



Etchmaster® 4-Hole Handpiece Starter Kit

Kit includes: EtchMaster® handpiece, 5 regular and 5 lingual small BE/50 hard abrasive tips. Attaches chairside.

Kit **EMHA**



Hard Abrasive Tips

50 micron aluminum oxide. Typically for restorative, preventive sealants, orthodontic brackets, and cosmetic bonding.

25/pkg.
Large - Lingual **EMTLL**
Large - Regular **EMTRL**
Small - Lingual **EMTSL**
Small - Regular **EMTRS**



Ram Power 45
Micro Motor/ Variable Speed

Variable speed dial 0-45,000 rpm. Safety overload protection and reset button. Selection for forward/reverse direction. Variable speed foot pedal.

Ea. **RAMPOWER45SETB**



Ram®
Vibrator 6"x8" Table

Ea. **VIBLG**



Metal Plaster Trap

An excellent plaster trap for offices or small labs. Top-mounted drain valve offers instant runoff benefits and the side sight-hole shows when the internal bag is filled. Aluminum construction with removable poly bags. 2¾ gallon capacity. 10½" H x 9¼" W. 10 year warranty.

Ea. **7000360**



Plaster Trap Liners

6/pkg. **7000403**



Plaster Trap Kits

Disposable

Easy way to dispose of plaster while conforming to EPA issues, the plaster traps are easy to install and change. Includes 2 attachment hoses, end caps, fittings, bucket & lid.

3.5 gal. **7000365**
5 gal. **7000366**



Plaster Trap Buckets

3.5 gal. **7000367**
5 gal. **7000368**



Plaster Trap Replacement Hoses

2/pkg. **7000369**



Air Vac XQ

Vacuum Former 110v

Utilizes compressed air to create all types of orthodontic appliances in less time, with precise adaptation and superior accuracy. 5-year warranty on parts and labor.

- Virtually silent operation
- "Bead well" feature
- Lab quality results
- Compact & lightweight
- 5-year parts & labor guarantee

Ea. **7000470**



ProForm 2

Vacuum Former 110v

- Dual chamber
- All aluminum construction
- Two-post sliding frame
- Center based vac motor
- 5-year parts & labor guarantee

Ea. **9594130**



ProForm Express

Vacuum Former 110v

- Non-rotating hexagonal post
- All aluminum construction
- Symmetrical heating unit
- 5-year parts & labor guarantee

Ea. **9594470**



Econo Vac III

Vacuum Former 110v

- Heavy-duty spring & latch
- All aluminum construction
- Symmetrical heating unit
- 5-year parts & labor guarantee

Ea. **7000330**



Trim-Rite®

Release Agent

Trim-Rite® release agent provides guaranteed separation between the working cast and the thermoformed plastic. Will not turn plastic yellow.

Ea. **21004**



Patient Supplies



G&H® supplies a complete line of disposables & consumables and patient support items.

Retainer Cases

These are the finest retainer cases specially designed for G&H® to be patient friendly & functional.



Secure locking mechanism keeps the case closed while a one-handed, easy-open release is featured. Varieties of colors give patients a wide choice.



Dimensions:
1" deep,
3 1/8" wide,
2 5/8" front to back

- **Unique Design**
- **One-Piece Vented Construction**
- **One-Handed Easy Release**

Patient Friendly Design

- Easy-Open – One-hand release
- Sleek Design – Goes anywhere
- 15 Different Colors, – Patient choice
- Vented Air Holes – Retainers stay fresh

Quality Construction

- Heavy Gauge Plastic – Durable
- One-Piece Construction – Sturdy & Unbreakable
- Everlasting Hinge Design – Long Life
- Stays Closed – Positive Lock-Tight Latch
- Right Size – Big enough for appliance, small enough to fit in pocket or purse

Order Options

- Wide Selection – 15 colors
- Single-Color Packs – Any color
- 50 Cases to a Pack – Single or Multi-color



Multi-Color Pack (15 colors)

50/pkg.

RETAS

Single Color Pack

50/pkg.

Black	RETBK	Purple	RETPP
Pink	RETPK	Red	RETRD
Blue	RETBK	Turquoise	RETTQ
Royal Blue	RETRB	Yellow	RETYE
Silver	RETSV	Fl. Yellow	RETYW
Green	RETGN	Clear	RETCL
Dk. Green	RETGR	White	RETWH
Orange	RETOR		



Deluxe

Retainer Cases

1 3/8" Depth.
25/pkg.

Assorted	700-020
Aqua	700-019
Black	700-017
Blue	700-013
Clear	700-016
Glow	700-023
Green	700-014
Neon Pink	700-010
Orange	700-011
Purple	700-018
Red	700-012
Yellow	700-015



Without Strap

Mouth Guards

10/pkg.

Assorted	Regular MG-MC	Junior SMG-MC
Blue	–	SMG-B
Black	–	SMG-BLK
Clear	MG-C	SMG-C
Yellow	–	SMG-Y



Regular

Junior

Ultra-Guard

Mouth Guards

10/pkg.

	W/Strap	W/O Strap
Assorted	58000D	58100D
Red	58001D	58101D
Green	58002D	N/A
Yellow	58003D	58103D
Blue	58004D	58104D
Black	58005D	58105D
Clear	58006D	58106D



12/pkg. Individually wrapped

	W/Strap	W/O Strap
Assorted	24000	24100
Clear	24006	24106



With Strap

Mouth Guards

10/pkg.

	Regular	Junior
Assorted	MGS-MC	SMGS-MC
Blue	MGS-B	SMGS-B
Black	MGS-BLK	SMGS-BLK
Clear	MGS-C	SMGS-C
Green	MGS-GRN	SMGS-GRN
Maroon	N/A	SMGS-M
Orange	MGS-OR	SMGS-OR
Purple	MGS-P	SMGS-P
Red	MGS-R	SMGS-R
Silver	MGS-SIL	SMGS-SIL
White	N/A	SMGS-W
Yellow	MGS-Y	SMGS-Y



Tuff Guard

Mouth Guards

3 openings for unrestricted breathing - convenient dispenser box.

5/pkg.

Assorted	TGD-MC
Black	TGD-BLK
Clear	TGD-C
Green	TGD-GRN
Maroon	TGD-M
Orange	TGD-OR
Purple	TGD-P
Red	TGD-R
Silver	TGD-SIL
Teal	TGD-T
White	TGD-W
Yellow	TGD-Y



Sonic Cleaner

Gets appliances, including retainers, sparkling clean in 5-10 minutes. When used in conjunction with Retainer Brite® tablets. Cleans deep - at 6,500 waves per second, and is a compact 3 1/2" x 4". Operates on two AA batteries (not included). Six-month replacement warranty included.

Ea.

SCL

NOTE: Sonic Cleaner and Retainer Brite are US sales only.



Retainer Brite®

Retainer Brite® cleaning tablets clean retainers, nightguards, mouthguards, splints and most other removable appliances.

- Helps remove plaque & tartar
- Kills germs & bacteria
- Cleans & brightens appliances

96 total tablets (bulk packed) **RB-92**

36 total tablets (bulk packed) **RB-36**

NOTE: Retainer Brite is US sales only.



Cool Mint

Listerine®

1.5 liter bottle

42755

Alcohol-Free

Listerine® Zero

(6) 1.3 liter bottles

257-1414



Full Line Quality Orthodontic Products

Orthodontists have one of the most important jobs – bringing renewed self-confidence and pride to every patient through improved smiles.

Order our full line of products at: GHOrthodontics.com

Johnson & Johnson®

Waxed Floss

5 yards. 144/pkg.

Regular **9863**
Mint **9864**



Waxed Floss

55 yards.

Ea. **30611P**



Refill

Patient Floss

200 yard refill.

Ea. **2733**
Mint **2749**
Regular



Refillable

Floss Dispenser

Ea. **207FSD**



Waterpik®

Power Flosser

Clinically proven as effective and easier to use than manual floss. Replaceable AA battery included.

Ea. **FLA-220**

Refill Tip Cartridge

30 disposable flossing tips per cartridge.

Ea. **FT-01**



Butler Gum® Eez Thru®

Flossers

Convenient on-the-go flossing. Super slick floss slides easily between teeth without shredding, breaking, or sagging.

3 Flossers/pack, 48 packs/box.
Ea. **891PA**



GUM™

Soft-Picks

GUM™ Soft-Picks have 76 soft, rubber bristles that easily slide between teeth and braces to remove food. They clean deep and are more gentle on gums than wooden or plastic picks.

5 Picks/envelope, 72 envelopes/box
Ea. **632P**



Gumpik™

Interproximal Picks

Assorted in 6 bright colors. 48 Picks/envelope, 48 envelopes/box
Ea. **2400**



Butler Gum® Eez Thru®

Floss Threaders

Helps thread floss under orthodontic appliances.

5 threaders per envelope, 100 envelopes/box
840P



Plak Smacker®

Ultra Thin Threaders

10 Threaders/Envelope, 100 Envelopes/pkg.

Ea. **10412**



Ordering online is quick and easy!



- How do I get started?
 - 1) Activate your account for online access - GHOrthodontics.com/activate
 - 2) Set your password
- Quick Reorder – Reorder products with just a few clicks – View 2-year order history
- Add product samples quickly to your order
- Updated product sections for easier ordering
- View latest product videos, brochures and catalogs



Disposable Toothbrushes

Soft end rounded bristles with U.S. formulated paste. Straight plastic 6.5" handle w/ narrow neck.

100/pkg.
Pre-pasted **10917**
Plain **10918**



Disposable Toothbrushes

Excellent for short-term use and as a low-cost brush for patients. Pre-pasted brushes are perfect for office visits.

100/pkg.
Regular **TB-25PW**
Pre-pasted **TB-25WITH**



Toothbrush Covers

Assorted colors.
144/pkg. **200TBX-A**



Tooth Brushing Timers

3-minute sand timers.
72/pkg. **20403**



Disclosing Tablets

Butler Gum® - Red
Helps detect harmful plaque on teeth. The red color reveals overlooked areas when brushing or flossing.

250/pkg. **00690112**



Interproximal Brushes

Elastomeric handle for better gripping control with protective cap that is an extended handle.

72/pkg.
Blue **20046**
Green **20047**



Interproximal Brush

This travel interproximal brush is the perfect hygiene tool for patients on the go. The clear cover conveniently converts into a handle, and the brushes are packaged in an assortment of colors. Colors include black, blue, red, purple, green and yellow.

100 brushes/pkg.
2mm - 3mm **2500**
2mm - 4mm **2600**
3mm - 7mm **2650**



Brush cover converts to a handle

Plaksmaker® Interproximal Brushes

The clear cover conveniently converts into a handle. 5 assorted colors.
144/pkg. **00027**



Convenient Travel Toothbrushes

Travel brushes come in assorted translucent colored covers which convert to a handle.
Straight bristles, 72/pkg. **00129**
V-Cut bristles, 72/pkg. **00122**



Deluxe Travel Toothbrushes

Plastic handle with a color matching opaque textured plastic case that becomes a handle extension. 4 assorted colors. Not individually wrapped.
72/box **44003**



Economy Travel Toothbrushes

4 assorted colors. Not individually wrapped.
72/box **44001**



Elasti Bites

Therapeutic Bite Wafers

25/pkg.

Cherry
Grape
Bubblegum

EB-25
EB-25G
EB-25PBG



Aligner Tray Seater

Chewies

- Best alternative to cotton rolls
- Provides uniform force in specific areas
- Seats aligners with an imperfect fit

20/pkg.

Mint/Green
Bubblegum/Pink
Plain/White

AC-25GMPP
AC-25PBGPP
AC-25WPP

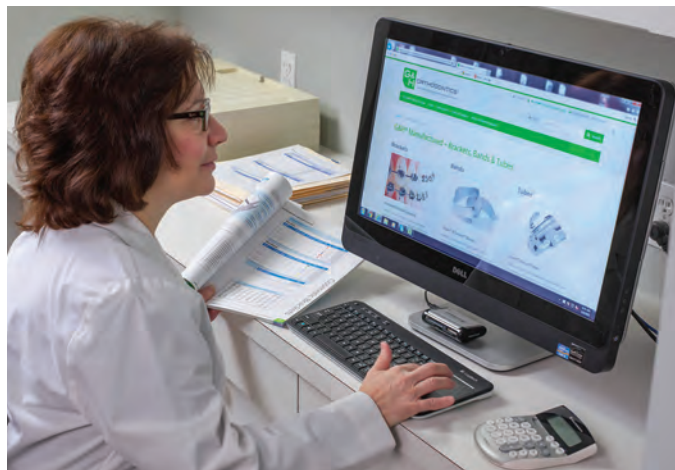

Discover Your Orthodontic Buying Power!

Your membership in the G&H OrthoClub® results in big savings. Enjoy buying-group savings on more than 6,000 brand-name clinical supplies including G&H manufactured products.

GHOrthodontics.com

BraceGard™ & Brace Relief™

These silicone patient packs offer superior protection from contact irritation during orthodontic treatment. Silicone provides a smoother, more comfortable surface than wax and will stay in place longer.

Brace Relief™ Silicone Patient Pack
Contains (4) 1 3/4" strips plus (1) 3g tube.

36 patient packs/box

79DT

Brace Relief and Brace Gard are trademarks of Infa-Lab, Inc. (Not for export to Europe.)



Embrace™ Lip Protectors

These flexible protectors fit over brackets and secure onto archwire to protect lip and cheek areas. Especially useful for musicians and others when lip irritation can be a problem. Not suitable for contact sports. Clear, Universal size.

10/pkg.

LPCL01



EMBRACE™
LIP PROTECTORS

BracSil

Ortho Relief Silicone

50/pkg.

700-099

Unscented

Patient Relief Wax

50/pkg.

Red
Silver

WB-R
WB-SIL



Patient Wax Packs

Our wax provides relief from most any source of contact irritation that occurs during orthodontic treatment. Specially formulated to stay in place and not dry out during use.

100/pkg.

Unscented
Cinnamon
Wintergreen

PWX536
PWX636
PWX736





Patient Survival Kit

Zip pouch survival kit includes handy pouch to insert your business card, rubber grip v-trim dual head toothbrush, spiral brush, 3-minute timer, V-trim travel toothbrush, mint relief wax, floss threaders, 15-yard mint floss spool and mouth mirror.
24 Kits/box, 6 boxes/case

Ea. **12031P**



Patient Health Care Kit

Includes travel toothbrush, 2 minute timer, interproximal brush, orthodontic wax, floss threaders, floss and mouth mirror.

Ea. **38008**



Patient Ortho Tote Bags

Plastic starter kit bag. 12" x 15"
100/pkg.

Boy/Girl **TOTEBG**
Red/White/Blue **TOTERWB**



Orthodontic Emergency Kit

Specially developed by an orthodontist for his patients, the kit allows patients to temporarily repair broken or loose wires until they can make an appointment. Fewer emergency calls for you and your staff on evenings and weekends, and your patients appreciate the value added service.

Ea. **969-456**



Elastics Placement Tool

These handy instruments help patients simplify the positioning of elastics. The double-ended design features a hook for pulling and a notched end for pushing elastics and placing as prescribed. They are available in a neon assorted pack with orange, yellow, purple, pink, and turquoise - or a basic assorted pack of silver, black, dark green, dark red, and dark blue.

100/pkg.
Neon assorted **EPT100**
Basic assorted **EPT150**



Elastics Storage Key Rings

These attractive key rings conveniently store intraoral elastics. They are available in neon assorted pack with orange, yellow, purple, pink, and turquoise - or basic assorted pack of silver, black, dark green, dark red, and dark blue. Each key ring includes one elastic placement tool.

50/pkg.
Neon assorted **ESC050**
Basic assorted **ESC150**



Mojo Monkey



Al E. Gator



Ollie Z. Mutt

Zoo Animal Teaching Aids

Help create a relaxed atmosphere for teaching good oral hygiene to patients of all ages. Animals are fully flossible and equipped with removable tongue and Velcro® toothbrush strap. Puppets allow for animated movement and include a small reservoir to squirt water for added entertainment. These plush animals are great for individual or group presentations. Approximately 15" seated. One toothbrush is included with each animal.

Ea.
Mojo Monkey **PM901**
Al E. Gator **PA400**
Ollie Z. Mutt **PD700**



Index

A

Abrasive Tips.....	157
Acetate Tracing Paper.....	137
Activation Keys.....	89
Aesthetic Bracket Systems.....	21
Agility®.....	17
Agility® Opener.....	18
Air/Water Syringe Tips.....	108
A.J. Wilcock® Australian.....	73
A.J. Wilcock® Australian Wire Products.....	77
A.J. Wilcock® Preformed Arches.....	78
Alcohol.....	153
Alginate.....	133
Alginate Flavoring.....	134
Alginate Remover.....	137, 151
Alginate Spatulas.....	135
Alginator II Mixer 110v.....	134
Aligner Remover.....	101
Aligner Tray Seater.....	164
Aligner Tray Seaters.....	101
Aluminum Oxide.....	156
Anesthetic.....	140
Anesthetic Spray.....	140
Antibacterial.....	153
Archforms.....	49, 79
Archwire Dispenser.....	49
Archwire Marking Pencils.....	140
Archwires.....	
A.J. Wilcock® Australian.....	73
Archforms.....	49, 79
Archwire Varieties.....	48
Coloboly™ Blue – Nickel Cobalt.....	76
Combination Lingual Archwire.....	73
DYB™ Pre-Torqued Archwire Series.....	83
Eight Strand (Woven).....	74
Force Value Graphs.....	51
G4orce™ Progressive Force Nickel Titanium Archwires.....	59
G4™ Nickel Titanium.....	55
G4™ NiTi Lingual Arches.....	71
G4™ Pre-Stopped Nickel Titanium Archwires.....	57
G4™ Pre-Torqued Nickel Titanium Archwires.....	58
G4™ Tooth-Colored Nickel Titanium.....	56
M5™ NiTi Lingual Arches.....	71
Material Science.....	50
Multi-Strand Stainless Steel.....	74
Platinum Proportion™ Archforms.....	84
Pre-Torqued Reverse Curve.....	61
Reverse Curve NiTi Archwires.....	60
S3™ Stainless Steel Archwires.....	66
S3™ Tooth-Colored Stainless Steel.....	67
Seven Strand (Twisted).....	74
Six Strand (Coaxial).....	74
Stainless Steel Looped Archwires.....	69
Thermal Copper Nickel Titanium Archwires.....	63
Three Strand.....	74
TitanMoly™ Titanium Molybdenum.....	65
Tooth-Colored Pre-Stopped.....	57
Tooth-Colored Reverse Curve.....	56
XR1™ Ball Post Archwires.....	70
XR1™ Heat-Treated Stainless Steel.....	68
Archwire Sleeve.....	96
Archwire Varieties.....	48
Articulating Paper.....	139
Assure®.....	102
Assure® Sealant.....	103
Australian Wire.....	77
A.J. Wilcock® Combination Arches.....	78
A.J. Wilcock® Preformed Arches.....	78
Autoclave Cleaner.....	151
Auxiliary Attachments.....	46

B

Ball Clasps.....	148
Ball Post.....	70
Ball Post Archwires.....	70
Bambino-Ties™.....	91
Band-Lok™.....	104
Band Organizer.....	41
Bands.....	
Saturn™ Molar & Bicuspid Bands.....	44
Saturn™ Bicuspid Bands.....	45
Saturn™ Molar & Bicuspid Band Kits.....	45
Titan™ Molar Bands.....	42
Titan™ Molar Band Kits.....	43
Barrier Milk.....	125
Barriers.....	155
Benda-Brush.....	106
Bibs.....	143
Bicuspid Bands.....	45
Bioform III.....	49
Biohazard.....	155
Bite Block Cover.....	155
Bite-Bumper™.....	112

Bite Registration.....	135
Bite Stick.....	123
Bite Wafers.....	147, 164
Bite Wax Sheets.....	147
Bonded Lingual Retainers.....	73
Bonding.....	106
Bite-Bumper™.....	112
Brush Tips.....	107
Dispensing Tips.....	106
Dry Field Kit.....	110
Fiber Reinforced Composite.....	113
Ketac-Cem®.....	106
Microbrushes®.....	106
Mini-Mold Kits™.....	112
Mixing Pads.....	107
Mixing Tips.....	105
Mixing Wells.....	107
Reliance® bonding products.....	102
SmartBond® Adhesive.....	110
Bonding Aligner Adhesive.....	102
Bonding Brushes.....	107
Brace Relief™.....	164
Bracket Holder - See also Instruments.....	25
Bracket Positioner - See also instruments.....	
Brackets.....	
Agility®.....	17
Agility® Opener.....	18
Focus™.....	11
miniPrevail®SL.....	14
Prism™.....	27
Self-ligating.....	14, 17
Vapor™.....	23
Bracket Tray.....	110
Bracket Tray Holder.....	110
Brass Separating Wire.....	76
Brush Tips.....	107
Buccal Tubes.....	32
Magnum™.....	37
Magnum™ Convertible Tubes.....	38
Magnum™ Non-Convertible Tubes.....	39
Viper™.....	32
Mini 2nd Tube.....	34
miniPrevail® Tube.....	30
Single Non-Convertible.....	33
Viper™ CV.....	35
Combination Convertible.....	36
Single Convertible.....	35
Bulk Ligature Wire.....	76
Burs.....	128
Carbide Burs.....	129
Diamond Burs.....	128, 129
Lab Cutter.....	128
Metal Cutting Carbide Burs.....	129
Trimming and Finishing Burs.....	129
Burs & Points.....	128
Button.....	46

C

Caliper.....	125
Caviwipes®.....	149
Ceph Film.....	146
Ceramic Bracket (See Vapor).....	23
Ceramic Button.....	101
Ceramic Buttons.....	46
Chain.....	94
Slim-Chain™.....	94
Chain Dispenser.....	94
Chair Covers.....	142
Cheek Retractor.....	109
Cheek & Tongue Retractor.....	109
Chem Pak.....	145
Chewies.....	164
Chin Cup Headcaps.....	117
Cinch-Back Plier (See Instruments).....	72
Clean & Lube Spray.....	136
Cleats.....	46
Coil Eyelets.....	46
Coil Springs.....	
G4™ NiTi Closed Coil Springs with Eyelets.....	86
G4™ NiTi Springs.....	86
Coloboly™ Blue Nickel Cobalt.....	75
Combination Buccal Tubes.....	36
Combination Lingual Archwire.....	73
Composite Brackets (See Prism).....	27
Composite Eyelets.....	46
Copper Nickel Titanium.....	63
Cotton Pellets.....	107
Cotton Roll Dispenser.....	152
Cotton Roll Holder.....	152
Cotton Rolls.....	152
Cotton Tip Applicators.....	152
Covers.....	140
Bite Block Cover.....	155
Chair Covers.....	142
Syringe Tip Cover.....	155
T-Light Handle Protector.....	155
Tray Covers.....	142
Crimpable Hooks.....	88

Crimpable Micro-Stops.....	88
Crimpable Stops.....	88
Crown Lok™.....	104
C.R. Syringe Mark II.....	107
Cup Holder.....	140
Cups.....	140
Custom I.Q.™.....	103
Custom Welding.....	33

D

Dappen Dish.....	107
Debubblizer.....	136
DesignerTies®.....	93
Developer.....	145
Diamond Burs.....	128
Diamond Disc.....	130
Discide® Ultra.....	149
Disclosing Tablets.....	163
Discs.....	130
Discs & Cutters.....	130
Disinfectant.....	149
Disinfecting Spray.....	149
Dispenser.....	152
Dispensing Tips.....	106
Disposable Toothbrushes.....	163
Dry Tips.....	108
Duncan Y. Brown.....	83
Duplicating Film.....	146
DYB™ Pre-Torqued Archwire Series.....	83
Dyna-Link™ Elastomeric Chain.....	94

E

Eight Strand (Woven).....	74
Elastic Power Thread.....	96
Elastics.....	96
Enchanted™ Series.....	98
Non-Latex Elastics.....	96
Private Logo Elastics.....	99
Elastics Placement Tool.....	165
Elastics Storage Key Rings.....	165
Elastomeric Chain.....	94
Dyna-Link™ Elastomeric Chain.....	94
PowerLink™ Chain.....	95
Slim-Chain™.....	94
Elastomeric Chain Dispenser.....	94
Elastomerics.....	
Canes.....	96
Color Chart.....	92
Elastomeric Separators.....	96
Elastomeric Separators.....	96
Enamel Reduction.....	130
Enhance L.C.™.....	105
Enzymatic Cleaner.....	150
epoxy coating.....	56, 67
Etchant.....	105
Europa™ I.....	49
Europa™ II.....	49
Evacuation Screens.....	108
Evacuation System Cleaner.....	150
everStick®Ortho.....	113
Excel®.....	103
Expansion.....	89
Expansion Screws.....	89
Palatal Expanders.....	89
Swivel Safety Activation Keys.....	89
Expansion Screws.....	89
Extrusion Chain.....	46, 110
Extrusion Hook.....	46, 110
Eyelets.....	46

F

Facebows.....	116
Face Mask.....	115, 143
Molded Cone Face Mask.....	143
Faci Forms.....	104
Fiber Reinforced Composite.....	113
Film.....	146
Fixer.....	145
Floss.....	162
Floss Dispenser.....	162
Flosser.....	162
Flossers.....	162
Floss Threaders.....	162
Flow Tain®.....	102
Fluoride Gel.....	161
Fluoride Toothpaste.....	161
Flux.....	148
Flux Paste.....	148
Focus™.....	11
Force Value Graphs.....	51
Former.....	158
Fuji Ortho.....	106

G

G4orce™ Progressive Force Nickel Titanium Archwires	59
G4™ Nickel Titanium Archwires	55
G4™ Nickel Titanium Springs	86
G4™ NiTi Coil Springs	87
G4™ Pre-Stopped Nickel Titanium Archwires	57
G4™ Pre-Torqued Nickel Titanium Archwires	58
G4™ Tooth-Colored Nickel Titanium Archwires	56
Gauze Sponges	153
General Purpose Cleaner	149, 150
Glasses	154
Glove Dispenser	144
Glove Rack	144
Gloves	144
Black Nitrile Gloves	144
Latex Gloves	144
Nitrile Gloves	144
Vinyl Gloves	144

H

Handpiece	126
Handpiece Lubricant	126
Handpiece Lubricating Pen Oiler	126
Handpiece Starter Kit	157
Hand Soap	153
Hand Wash Gel	153
Headcaps	117
Headgear Pouches	117
Headgear Storage Cases	117
Headrest Covers	140
Heatless Stone	147
Heat-Treated Stainless Steel Archwires	68
Hilgers Bond-A-Braid™	105
Hooks	88
Shepherd Hooks	88
Surgical & Arch Hooks	88
"Y" Hooks	88

I

Impression	
Alginate	133
Alginate Flavoring	134
Alginate Remover	137
Alginator	134
Clean & Lube Spray	136
Impression Trays	133
Mixing Tips	135
Tongue Filler	136
Tray Adhesive	134
Tray Adhesive Spray	137
Tray Cleaner	137
Utility Wax Strips	133
Impression Material	134
Impression Trays	132
Impression Wax	136
Indicator Labels	152
Indicator Tape	152
Instrument Code Rings	125
Instrument Rack	124
instruments	
Adhesive Remover Pliers	120
Band Removing Pliers	120
Band Seater	121
Bird Beak Pliers	120
Bite Stick	123
Boone Gauge	123
Bracket Holder	122
Bracket Removing Pliers	120
Bracket Tweezer	122
Buccal Tube Tweezer	122
Cutter	118
Digital Caliper	125
Distal Bender	121
Explorer	121
Finishing Pliers	120
Force Gauge Dynamometer	121
Forming Pliers	119
FRC Placement Tool	123
Handpiece	126
Hollow Chop Pliers	120
Hook Crimping Pliers	120
HOW Utility Pliers	119
Jaraback Pliers	119
Ligature Director	121
Ligature Tier	121
Light Wire Pliers	120
Loop Forming Pliers	119
Mathieu Hemostat	122
Mershon Band Pusher	121
Mosquito Hemostat	122
Posterior Bond Placer	123
Separating Plier	123
Stop "V" Bend Pliers	120
Therma-Stick™	123
Weingart Utility Pliers	119

Wire Contouring Pliers	120
Instrument Stain Remover	124
Interproximal Brushes	163
Interproximal Diamond Bur	129
Interproximal Picks	162
Interproximal Strips	131

K

Ketac-Cem®	106
Keyhole	69
Koby Ties	76

L

Lab Stone	137
Latex Elastics	98
L.C.R.™ Light Cure Retainer	102
Ligature Ties	76
Bambino-Ties™	91
Bulk Ligature Wire	76
Color Chart	92
Elastomeric Ligature Display Booklet	92
Koby Ties	76
Pre-cut Ligature Ties	76
Stainless Steel	76
Versa-Ties™	91
Light Bond®	102
Lightning Strip Handle	131
Lightning Strips	131
Lingual Archwires	71
Lingual Archwires - Preformed	71
Lingual Archwires - Universal	72
Lingual Buttons	46
Lingual Cleats	46
Lingual Retainers	73
Lingual Sheaths	46
Lip Bumpers	116
Lip & Cheek Retractors	109
Lip Protectors	164
Lip Retractor	109
Listerine®	161
Looped Archwires	69
Lotion	153

M

M5™ Thermal Copper Nickel Titanium	63
Magnifier	148
Magnum™ Buccal Tubes	37
Magnum™ Convertible Tubes	38
Magnum™ Non-Convertible Tubes	39
Mandrels	131
Marking Film	139
Maximum Cure®	103
Measuring Gauges	125
Microbrushes®	106
MicroEtcher	156
Micro Motor	157
Millimeter Ruler	125
Mini 2nd Tube	34
Mini-Mold Kits™	112
Mini Twin	6
Mirror Handle	139
Mirrors	138
Angled Occlusal Mirror	138
Mirror Handle	139
Mouth Mirrors	139
Photographic Mirrors	138
Sterilization Recommendations	138
Mixing Bowls	136
Mixing Pads	107
Mixing Spatula	107
Mixing Tips	105, 135
Mixing Wells	107
MM Ruler	69
Model Glow Soap	137
Model Storage Boxes	137
Molar Band Systems	41
Molar Distalizing Open Coil Springs	87
Motor	125
Mouthguard Resin Material	148
Mouth Guards	160
Mouth Mirrors	139
Mouth Props	109
Multi-Strand Stainless Steel	74
mushroom® shape lingual archform	71

N

Neckpads	117
NEOsmile™	114
Nickel Titanium	55
Nickel Titanium Archwires	55
NiTi Closed Coil Springs	86
Non-Latex Elastics	96

O

Occlusal Marking Film	139
Oral Evacuators	108
Orthodontic Emergency Kit	165
Ortho FlexTech™	105
Overbite Ruler	125
Oxide Jars	157

P

Pad Lock™	102
Palatal Arch Bars	88
Palatal Expanders	89
Pan Film	146
Paper Towels	154
Paragon™ Instruments	118
Patient Bibs	143
Patient Health Care Kit	165
Patient Relief Wax	164
Patient Survival Kit	165
Patient Wax Packs	164
Perfect-A-Smile™	104
Phase II®	103
Photographic Mirrors	138
Pink Wax	147
Plasters	137
Plaster/Stone Remover	151
Plaster Trap	158
Plaster Trap Buckets	158
Plaster Trap Kits	158
Plastic Cups	140
Plastics	148
Platinum Proportion™ Archforms	84
Plier Rack	124
Pliers	119
Polishing Brushes	131
Pontic Paint	104
Porc-Etch™	105
Portal® Bonding Base	23
Post Archwires	70
PowerLinx™ Chain	95
Power Thread	96
Precedent®	104
Pre-cut Ligature Ties	76
Pre-Stopped	57
Pre-Stopped Nickel Titanium	57
Pre-Torqued	58
Pre-Torqued Nickel Titanium	58
Pre-Torqued Reverse Curve	61
PRISM	27
Private Logo Elastics	99
Processor Cleaner	145
Progressive Force	59
Prophy Angles	126
Prophy Cup Holder	127
Prophy Cups	127
Prophy Paste	127
Props	109
Pro Seal™	103
Protraction Face Mask	115
Pulse Straightened	77
Pumice	127
Pumice Preppies	127

Q

Quick Cure™	102
-------------	-----

R

Rag Wheel	147
Refrigerant Spray	148
Releasing Agent	147
Reliance®	102
Reliance® bonding products	
1st & Final™	105
Assure®	102
Assure® Sealant	103
Band-Lok™	104
Bonding Aligner Adhesive	102
Crown Lok™	104
Custom I.Q.™	103
Enhance L.C.™	105
Faci Forms	104
Flow Tain®	102
Hilgers Bond-A-Braid™	105
L.C.R.™ Light Cure Retainer	102
Light Bond®	102
Maximum Cure®	103
Ortho FlexTech™	105
Pad Lock™	102
Perfect-A-Smile™	104
Phase II® Dual Cure	103
Porc-Etch™	105
Precedent®	104
Pro Seal™	103
Quick Cure™	102
Rely-A-Bond®	103

Renew Finishing System™.....	105	Nickel Titanium.....	75	Topical Anesthetic.....	140
Retainium™.....	105	Soft Stainless Steel Wire.....	75	Torch.....	148
Sealants.....	103			Towel.....	143
Ultra Band-Lok™.....	104			towelettes.....	149
Relief Silicone.....	164	Springs		Towel Holder.....	154
Relief Wax.....	164	G4™ NiTi Coil Springs.....	87	Tracing Paper.....	137
Rely-A-Bond®.....	103	Molar Distalizing Open Coil Springs.....	87	Travel Toothbrushes.....	163
Renew Finishing System™.....	105	Separating (NEET) Springs.....	87	Tray.....	142
Resin Acrylic.....	147	Stainless Steel Coil Springs.....	87	Tray Adhesive.....	134
Retainer Brite®.....	101, 161	Stainless Steel Ligature Ties.....	76	Tray Adhesive Spray.....	137
Retainer Cases.....	160	Stainless Steel Looped Archwires.....	69	Tray Covers.....	142
Retainer Material.....	148	Stainless Steel Open Coil Springs.....	87	Tray Lids.....	142
Retainium™.....	105	Steel Ligature Ties.....	76	Tray Racks.....	142
Retention Systems.....	105	Sterilant.....	150	Tray Sleeves.....	142
Retraction Arches.....	69	Sterilization Pouch.....	151	Trueform™ I.....	49
Retractor.....	109	Sterilization Strips.....	152	Tubes.....	30
Reverse Curve.....	60	Stones.....	128	Tubing.....	96
Reverse Curve NiTi Archwires.....	60	Stops.....	88		
Reverse Pull Face Mask.....	115	Straight Lengths.....	75	U	
Rotation Wedges.....	96	Colboly™ Blue Nickel Cobalt.....	75	Ultra Band-Lok™.....	104
		Nickel Titanium.....	75	Ultrasonic.....	150
S		Stainless Steel Spring Tempered Wire.....	75	Ultrasonic Cleaner.....	151
Safety Glasses.....	154	TitanMoly™ Titanium Molybdenum.....	75	Utility Wax Strips.....	147
Safety Guard.....	131			UV Glasses.....	154
Safety Release Modules.....	116	Straight Post Archwires.....	70		
Saliva Ejectors.....	108, 109, 126	Surface Barrier Film.....	155	V	
Saliva Ejector Traps.....	108	Surgical & Arch Hooks.....	88	Vacuum Former.....	158
Sand Traps.....	157	Surgical Milk.....	125	Vapor™.....	23
Saturn.....	41	Swivel Safety Activation Keys.....	89	Versa-Ties™.....	91
SATURN™ bicuspid bands.....	45			Vibrator.....	157
Saturn™ Molar & Bicuspid Band Kits.....	45	T		Viper™.....	32
Saturn™ Molar & Bicuspid Bands.....	44	TAD spring.....	86	Viper™ Buccal Tubes.....	36
Scientific Testing.....	50	Tartar & Stain Remover.....	149	Viper™ CV.....	35
Sealants.....	103	Teaching Aids.....	165		
Seating Lug.....	46	Thermal Copper Nickel Titanium Archwires.....	63	W	
Self-Ligating.....	17	“T” Hooks.....	88	Wax.....	147
Separating Medium.....	136	Thread.....	96	Waxed Cloth.....	136
Separating (NEET) Springs.....	87	Threaders.....	162	Wax Packs.....	164
Separating Wire.....	76	Three Strand.....	74	Wax Sheets.....	136
Seven Strand (Twisted).....	74	Titan.....	41	Wax Strips.....	133, 147
Sharps Containers.....	155	Titanium Molybdenum.....	65	Wet Field Bonding.....	110
Sheaths.....	46	TitanMoly™.....	65	Wheel Saw.....	131
Sheet Wax.....	136	Titan™ Molar Band Kits.....	43		
Shepherd Hooks.....	88	Titan™ Molar Bands.....	42	X	
Silver Solder.....	148	T-Light Handle Protector.....	155	XR1™ Ball Post Archwires.....	70
Six Strand (Coaxial).....	74	T-Loop.....	69	XR1™ Heat-Treated Stainless Steel Archwires.....	68
Skin Lotion.....	153	Tongue Depressors.....	153	X-Ray Apron.....	145
Slim-Chain™.....	94	Tongue Filler.....	136		
SmartBond® Adhesive.....	110	Toothbrush Covers.....	163		
Soft Stainless Steel Wire.....	75	Toothbrushes.....	163		
Solder.....	148	Tooth Brushing Timers.....	163		
Sonic Cleaner.....	101, 161	Tooth-Colored.....	56		
Spatulas/Knives.....	135	Tooth-Colored Nickel Titanium.....	56		
Split-Cast Large Formers.....	137	Tooth-Colored Reverse Curve.....	56		
Sponge Dispenser.....	153	Tooth-Colored Stainless Steel Archwires.....	67		
Sponge Pellets.....	107	Tooth Dryer.....	125		
Spooled Bulk Ligature Wire.....	76	Tooth Positioner.....	114		
Spooled Wire.....	75				

Payment Options

Net 30 days, upon credit approval. Past due balances may be charged 1.5% per month finance charge at the sole discretion of G&H®. G&H® accepts Mastercard, Visa and American Express for any purchase. When using credit cards, please provide complete name, card number and expiration date, and CVV2 code. We request a minimum order of U.S. \$25 to help keep processing costs down.

Pricing and Policies

Product pricing is available online for G&H® customers by logging onto the G&H® website with your customer number and password. Or, you can call us at 1-800-526-1026 during our regular office hours and our customer service representatives will be happy to assist you.

We are constantly engaging in research to improve our quality and design. Therefore, G&H® reserves the right to improve, modify, or discontinue products at any time without prior notice. All prices are in U.S. funds and are subject to change without notice. Purchaser assumes all risk and liability resulting from the use of these products. In the event of any claimed defect, G&H®'s sole responsibility is limited to the replacement of the material, or at G&H®'s option, issuing credit for the purchase price. G&H® will not be responsible for other claims for incidental and consequential damages. Any and all implied warranties of merchantability or fitness for any particular purpose or use are waived and excluded.

Return Policy

G&H® warrants all materials and workmanship to be free from defects. Products must be returned within 90 days from date of purchase and must be returned in original packaging and in resalable condition. G&H® reserves the right to final determination as to acceptance of product for exchange or credit. Restock fees may apply. Prior to the return of any merchandise, please contact G&H® Customer Service for a return authorization number.

Shipping Options

All domestic and international orders are shipped via UPS unless a specific carrier is preferred and approved prior to ordering. Alternate shipping services are available including express or overnight shipping where available - please call for more information.

Trademarks

G&H, OrthoForce, OrthoClub, miniPrevail and the G&H logo are registered trademarks of G&H Wire Company. The following trademarks/service marks and copyrights in this catalog are the property of G&H® Wire Company:

Accu-Lock, Agility, Comfort Zone, Focus, Magnum, Lucent, Prism, Mirage, Clarion, Diamante, Viper, Vapor, Titan, Saturn, Paragon, Armada, Excelsior, G4, M5, XR1, TitanMoly, G4orce, Zenith, SureGrip, Embrace, Edge-Lok, Enforce frc, Colboly, Straight-Line, Ultraesthetic, Enchanted, Xtreme, Slim-Chain, Dyna-Link, Versa-Tie, Bambino-Tie, Solo-Pack, Europa, Trueform, Thermo-Frost, Thermo-Stick, NEOsmile, DYB, “With G&H® OrthoForce® orthodontic archwires, you are always in control.”, “Nobody knows NiTi like G&H®”.

All other trademarks are property of their respected owner.

© 2018 G&H® Orthodontics

G&H® Wire Company holds certification for ISO 13485:2003 and the Medical Device Directive 93/42, 2007/47/EC as well as the Canadian Medical Device Guidelines.

Thank you! We appreciate your business.



G&H® makes brackets in the U.S.A., and that makes the difference.



G&H® BRACKETS MOST PREFERRED BY ORTHODONTISTS

Vapor™ Ceramic Bracket System | miniPrevail®TWIN Metal Bracket System



Bracket features at-a-glance

State-of-the-art engineering and the highest-quality materials

Mini twin design for comfort and control

Distinctive compound contoured mesh bonding base for anatomical fit

Revolutionary bonding base - adhesive flows through the portals for unprecedented secure bonding and safe debonding

MIM* | CIM* manufactured for bracket strength

Parallel tie wings / Rhomboidal shape

No special debonding instrument required

Excellent value - manufacturer pricing

Available in popular bracket prescriptions

Roth

High Torque

MBT

Edgewise

Nearly invisible, aesthetic appearance

Temporary color-coded ID system with permanent identification indents for ease of use

Full rotational control

Low profile and rounded facial contours for patient comfort

	miniPrevail®TWIN	Vapor™
State-of-the-art engineering and the highest-quality materials	✓	✓
Mini twin design for comfort and control	✓	✓
Distinctive compound contoured mesh bonding base for anatomical fit	✓	
Revolutionary bonding base - adhesive flows through the portals for unprecedented secure bonding and safe debonding		✓
MIM* CIM* manufactured for bracket strength	✓	✓
Parallel tie wings / Rhomboidal shape	✓	✓
No special debonding instrument required	✓	✓
Excellent value - manufacturer pricing	✓	✓
Available in popular bracket prescriptions	✓	✓
Roth	✓	✓
High Torque	✓	✓
MBT	✓	✓
Edgewise	✓	✓
Nearly invisible, aesthetic appearance		✓
Temporary color-coded ID system with permanent identification indents for ease of use	✓	✓
Full rotational control	✓	✓
Low profile and rounded facial contours for patient comfort	✓	✓



Have questions about our brackets?

call: **800-526-1026**

*MIM - Metal Injection Molding, CIM - Ceramic Injection Molding



ORTHODONTICS®
Quality Manufacturing. Exceptional Service.



Over 6,000 Products!
Brand Names You Know and Trust

The Club With Clout! Your membership in the unique G&H OrthoClub results in big savings for you. Enjoy buying-group savings on brand-name clinical supplies as well as all G&H manufactured products, plus get special member only offers and discounts. Join the club and save!

GHOrthoClub.com



BRACKETS



BANDS



TUBES



WIRES



SPRINGS



ELASTOMERICS

G&H® proudly precision manufactures a full line of orthodontic products in the U.S.A.

GHOrthodontics.com

2165 Earlywood Drive Franklin, IN 46131 USA
800-526-1026 U.S. & Canada +1 317-346-6655 International
Email us at orders@GHOrtho.com



MKT.001.C_V15