

# Rollair®

## Air Compressors

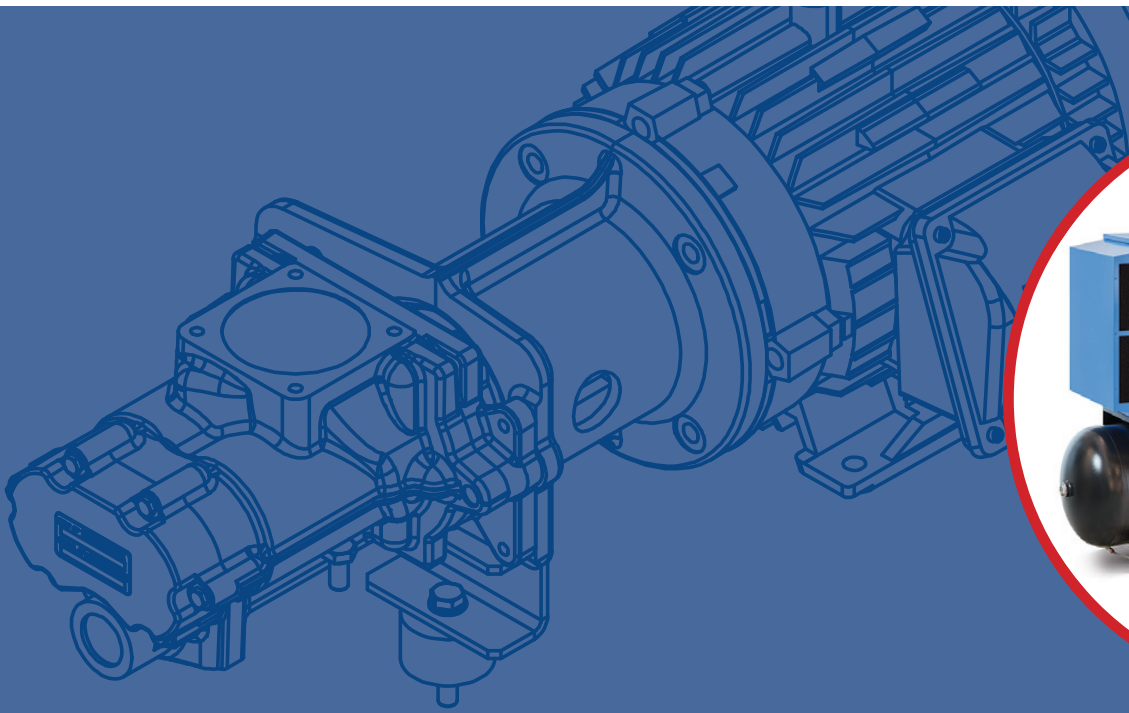

RLR 550-2000 & RLR 10-15-20E V

## Worthington Creyssensac's heritage

Creysensac was founded in Nanterre (near Paris), France in 1934 by Elie Creysensac and quickly became renowned in the automotive industry for developing high quality piston compressors.

In the mid nineteen sixties, screw compressors were added to the product portfolio while 1973 saw the merge with Worthington. This further expanded the influence of the company in the compressed air world and reinforced the distributor network.

Today, its long-standing experience and continuous innovation ensure Worthington Creyssensac is a trusted partner for its customers.



**INNOVATION  
HANDS-ON  
EXPERIENCE  
PEACE OF MIND  
TOTAL COST  
OF OWNERSHIP  
PARTNERSHIP**

## Driven by technology Designed by experience

Discover what happens when a passion for technology is fused with hands-on industrial experience. Designs evolve towards more practical installation and maintenance, giving you the freedom to focus on your job. Product ranges include the exact machine you need, with the right options for your performance needs. Return on investment is ensured, while your carbon footprint shrinks. And, because we stay close to our customers, we're one step ahead when your needs change.

## The range that meets all your requirements

*With our Rollair range you obtain an efficient, reliable and complete solution which fits a wide range of compressed air requirements.*

### A wide offer for you

- Fixed speed belt driven from 5,5 up to 20 hp available in 3 pressure variants (8-10-13 bar).
- Variable speed direct driven models available at 10, 15 and 20 hp, each model can cover one pressure range (5,5-12,5 bar).
- Floor- or tank-mounted with or without integrated dryer.

### Easy to install and maintain

- Easy to install thanks to a high variety of configurations and scope of supply.
- Easy to service thanks to the large removable panels.
- Low maintenance costs.

### Direct drive air end (RLR 10-20EV)

- Up to 15% lower SER, FAD increase of 20% compared to previous version.
- Lower energy losses compared to belt or gear applications.

### The options you need

- Graphic and integrated central controller.
- Compressed air filter to improve the air quality.
- WSD to protect your dryer from moisture.
- ...and much more to customize your machine!

### Improved sound installation

- As low as 61 dB(A).
- Compressor can be installed in the workshop.

[www.airwco.com](http://www.airwco.com)

## RLR 550-2000: simplicity and reliability

*The RLR 550-2000 sets a new standard for operational power, quality, operation safety, service life and user comfort.*

### Compact design

Offering best-in-class performance and total reliability, the RLR 550-2000 range answers your advanced compressed air needs.

- Industry-leading Free Air Delivery.
- Very low power consumption and the lowest noise emission in the industry.
- Excellent quality, dry air thanks to the integrated dryer range (1).
- Easy monitoring and maintenance thanks to the Infologic/Airlogic<sup>2</sup> controllers (2).
- Tank-mounted solution to save space (3).
- The WSD (4) combined with floating zero loss drain allows the removal of condensate without wasting compressed air resulting in significant energy savings.

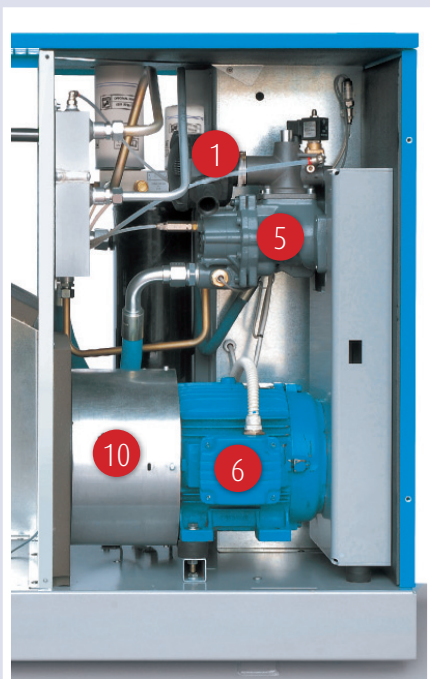

## Improved efficiency

- Highly efficient and well tested air ends (5) grant you total peace of mind.
- Reduced energy consumption thanks to IE3 electric motor class F on insulation, IP55 protection (6).
- Robust and long lasting belt transmission (7) easy and fast to tension.
- Oil separator designed to ensure minimal pressure drop and oil carryover of less than 3 ppm (8).

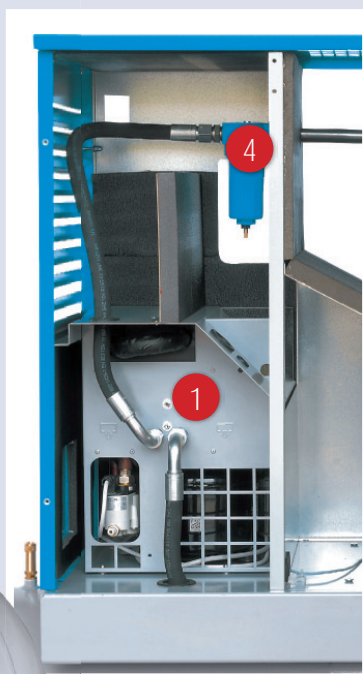
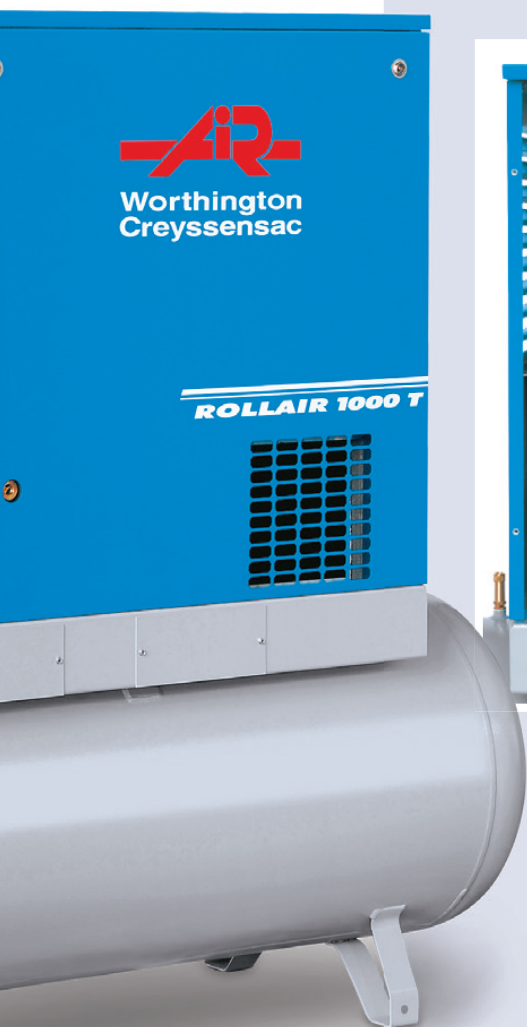

## User comfort

- Very low noise level allows installation of the machine close to the workplace.
- Easy oil level check via external oil level sight glass.
- Smooth serviceability possible due to easily removable panels.

# RLR 10-20EV: the highest standards

*Minimized energy consumption for the most demanding applications, making major energy savings a reality, this is the RLR 10-20EV.*

## Improved efficiency

- Highly efficient and well tested air ends (1) combined with direct transmission (2) and the new converter (3) grant SER and FAD improvement up to 20% versus the previous generation.
- Oil separation (4) designed to ensure minimal pressure drop and oil carryover of less than 3 ppm.

## Compact design

- Tank-mounted solution to save space (5).
- Oversized integrated refrigerant dryer (6) simplifies your installation and ensures high quality compressed air.

## User comfort

- Very low noise level allows installation of the machine close to the workplace.
- Easy oil level check (7) via external oil level sight glass.
- Smooth serviceability possible due to easily removable panels.
- Easy to move and position thanks to forklift lifting points (8).

## At your service, also in very harsh conditions

- Efficient filtration (9).
- Generous electric fan (10).
- Very big vertical cooler (11) ensuring the best cooling flow to work up to 46°C ambient temperature.



## Personalised for you

*RLR 10-20E and RLR 550-2000 are available floor-mounted and tank mounted both with or without dryer. Air receiver capacities are 270 and 500 lt. A wide range of options enables you to get the most out of your RLR compressor.*

### Air quality

**Internal water separator with automatic drain (7)** removes up to 90% of the compressed air moisture (standard with dryers).

**Line filter** for oil and dust removal down to 0.1 ppm (optional for units with integrated dryer).

**Easy to drain air receiver** thanks to timer drain (standard on tank-mounted versions) (12).

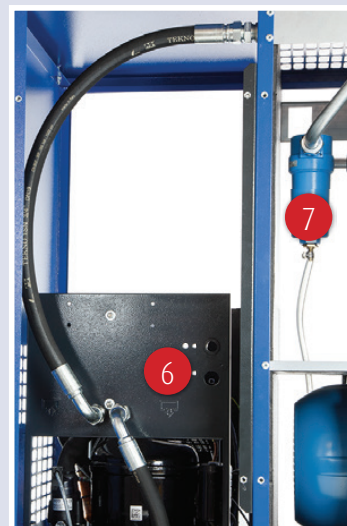
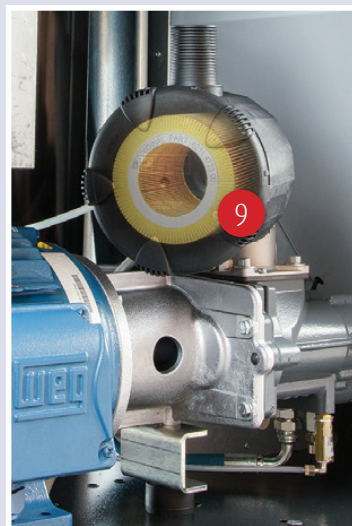

### Connectivity

**Econtrol 4/6 (integrated), available for Airlogic<sup>2</sup> (see next page):** for compressor room management, hours equalization and further energy saving thanks to working pressure reduction.

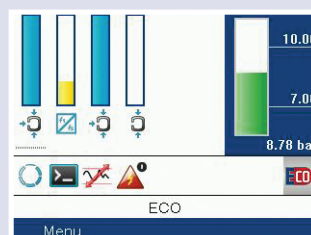
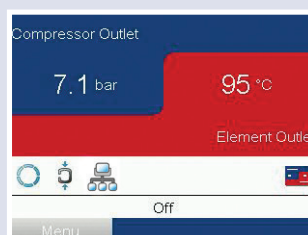

For further information on how our options can optimize your operations, please contact your local representative.

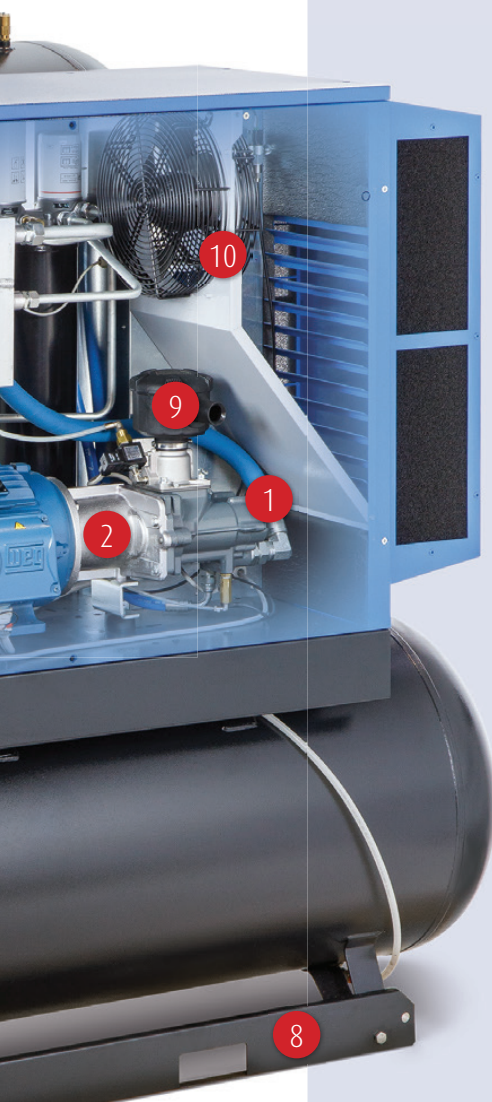

# How to optimize your energy consumption

Energy costs represent about 70% of the total operating cost of your compressor over a 5-year period. That is why reducing the operating cost of our compressed air solutions is a major focus.

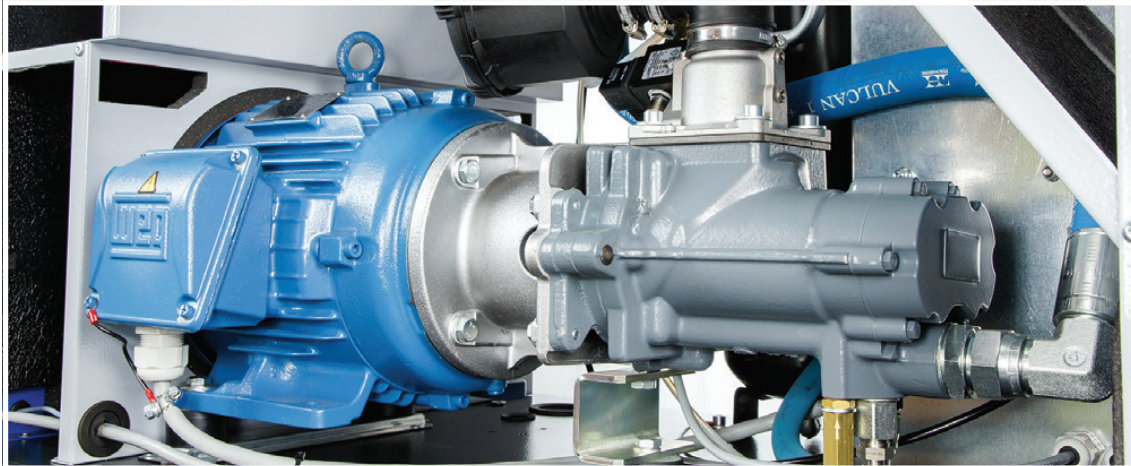

For the right application, variable speed technology can cut the energy bill of your compressor by up to 30%.

Variable speed technology reduces energy consumption in the following ways:

- The variable frequency drive compressor matches air supply with demand therefore reducing energy consumption when the demand is lower. If the demand is stable then the Air Control controller guarantees a fixed set pressure.
- No unload cycles above 20% load.
- No peak current due to soft start.

Variable speed technology

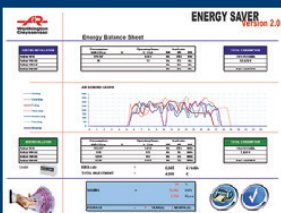
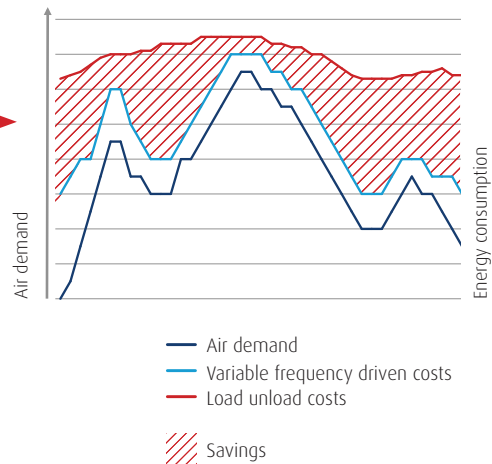
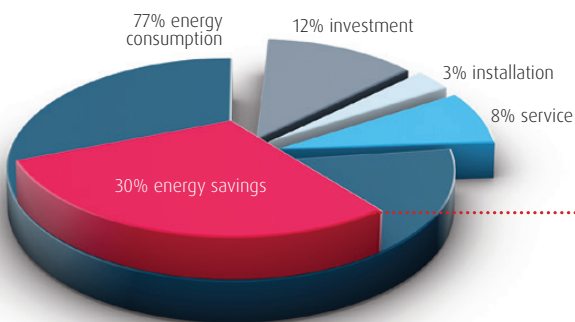

## Energy audit

To optimize your energy efficiency, you need to select the right compressor. Contact your local Worthington Creyssensac representative and we will perform a simulation based on your parameters to help you get the perfect compressed air solution.



## Always in control with Infologic<sup>2</sup> and Airlogic<sup>2</sup>



### Infologic<sup>2</sup> (standard)

- Icon-based display action
- Led status visualization.
- Digital I/O.
- Remote start stop, load-unload, emergency stop.
- Automatic restart after a power failure.
- Service indicator and fault management provide comprehensive messages to ease service diagnostics.
- Visualization through web browser using a simple Ethernet connection.



### Airlogic<sup>2</sup> (optional)

The Airlogic<sup>2</sup> takes your control to the next level, offering additional functionalities:

- User-friendly graphic screens, data logging and storage on a memory card.
- Stop/start timers do not rely on the operator's action to save energy, but program the Airlogic<sup>2</sup> controller to operate as your factory operates.
- Dual pressure band time scheduling for operation with different pressure bands, leading to energy savings.

## Central control EControl6

For installations with multiple compressors a cascade system with a wide pressure band used to be the only way to run these. This control method was costly as a wide pressure band was required. Additionally, the running hours of the compressors were not synchronized making strategic serving difficult. The EControl6 can manage all of this for you.

### Control features

- Single pressure measurement point
- Minimized pressure band
- Stable system pressure
- Equalization of running hours
- Multiple IVR speed control



# Technical specifications

## Fixed speed

Model		Working pressure	Free Air Delivery @ reference conditions			Motor power		Noise level **	Cooling air flow	Weight			
		bar	m <sup>3</sup> /h	l/s	cfm	kW	hp	dB(A)	m <sup>3</sup> /h	FM	Extra weight for 270l	Extra weight for 500l	Extra weight for dryer
		kg											
Rollair 550	A	8	36	10,0	21,2	4	5,5	59	2200	185	60	160	35
	B	10	30	8,3	17,7								
Rollair 750	A	8	50	13,9	29,5	5,5	7,5	60	2200	195	60	160	35
	B	10	41,5	11,5	24,5								
	C	13	30,2	8,4	17,8								
Rollair 1000	A	8	70	19,4	41,3	7,5	10	61	2200	215	60	160	35
	B	10	59,8	16,6	35,3								
	C	13	47,9	13,3	28,3								
Rollair 1500	A	8	102	28,3	60,2	11	15	61	2200	256	60	160	35
	B	10	86	23,9	50,7								
	C	13	71,7	19,9	42,3								
Rollair 2000	A	8	121,5	33,8	71,7	15	20	62	2800	276	60	160	35
	B	10	108,6	30,2	64,1								
	C	13	90,9	25,3	53,6								

## Variable speed

Model	Min working pressure		Max working pressure		Free Air Delivery at reference conditions										Motor power		Noise level	Cooling air flow		
	bar	psi	bar	psi	Min FAD[7bar]		Max FAD								kW	hp	dB(A)	m <sup>3</sup> /h		
					m <sup>3</sup> /h	cfm	7 bar		5 bar		7 bar		9,5 bar						12,5 bar	
							m <sup>3</sup> /h	cfm	m <sup>3</sup> /h	cfm	m <sup>3</sup> /h	cfm	m <sup>3</sup> /h	cfm						
Rollair 10 V	5,5	80,0	12,5	181,0	16,6	9,6	77,0	44,7	75,0	43,5	64,8	37,6	51,0	29,6	8	10	62	2200		
Rollair 15 V	5,5	80,0	12,5	181,0	16,2	9,4	114,0	66,2	111,6	64,8	90,0	52,3	73,8	42,9	11	15	63	2200		
Rollair 20EV	5,5	80,0	12,5	181,0	15,8	9,2	140,0	81,3	135,7	78,8	113,8	66,1	85,3	49,5	15	20	64	2200		

## Weight

Model	FM	Extra weight for 270l	Extra weight for 500l	Extra weight for dryer
	kg			
Rollair 10 V	257	60	160	35
Rollair 15 V	271	60	160	50
Rollair 20EV	290	60	160	55



## Dimensions

	RLR 550-2000 (mm)			RLR 10-15-20 V (mm)		
	Length	Width	Height	Length	Width	Height
<b>FM</b>	1165	655	1045	1165	662	1045
<b>FM + dryer</b>	1585	655	1045	1595	662	1045
<b>TM 270 I</b>	1535	655	1535	1530	662	1531
<b>TM 270 I + dryer</b>	1655	655	1550	1595	662	1531
<b>TM 500 I</b>	1935	655	1665	1935	662	1665
<b>TM 500 I + dryer</b>	1935	655	1680	1935	662	1665





**Worthington  
Creysensac**

**DRIVEN BY TECHNOLOGY DESIGNED BY EXPERIENCE**



**CONTACT YOUR LOCAL  
WORTHINGTON CREYSSENSAC  
REPRESENTATIVE.**

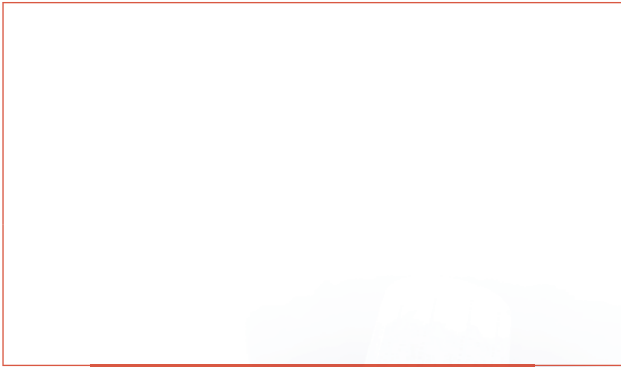

**Care. Trust. Efficiency.**

**Care.**

Care is what service is all about: professional service by knowledgeable people, using high-quality original parts.

**Trust.**

Trust is earned by delivering on our promises of reliable, uninterrupted performance and long equipment lifetime.

**Efficiency.**

Equipment efficiency is ensured by regular maintenance. Efficiency of the service organization is how Original Parts and Service make the difference.

6999010042